

# Distinctive Characteristics

Ultra-miniature size allows high density mounting, and extremely light weight of 0.25 gram makes these switches ideal for handheld equipment.

Totally sealed body construction prevents contact contamination and allows time- and money-saving automated soldering and cleaning.

Molded-in, epoxy sealed terminals lock out flux, solvents, and other contaminants.

Award-winning STC contact mechanism with benefits unavailable in conventional mechanisms: smooth, positive detent actuation, increased contact stability, and unparalleled logic-level reliability. (Additional STC details in Terms & Acronyms; see Supplement section.)

.100" x .100" (2.54mm x 2.54mm) terminal spacing conforms to standard PC board grid spacing. Round terminals facilitate easier through-hole mounting on PC boards.

Matching indicators available and shown at the end of Section M.

G Series illuminated toggles also appear in the Illuminated Other Section M.

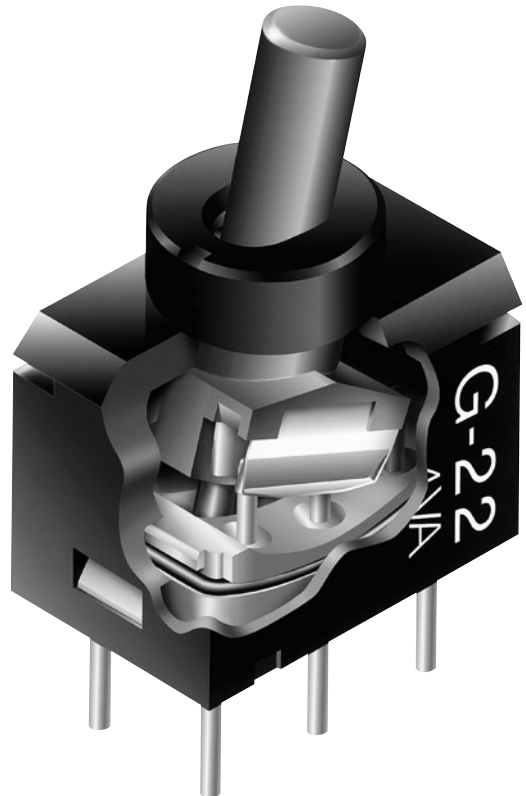

Actual Size

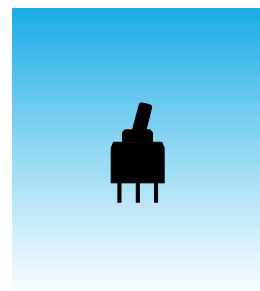

# General Specifications

## Electrical Capacity (Resistive Load)

**Logic Level:** 0.4VA maximum @ 28V AC/DC maximum  
 (Applicable Range 0.1mA ~ 0.1A @ 20mV ~ 28V)  
 Note: Find additional explanation of operating range in Supplement section.

## Other Ratings

**Contact Resistance:** 80 milliohms maximum  
**Insulation Resistance:** 500 megohms minimum @ 500V DC  
**Dielectric Strength:** 500V AC minimum for 1 minute minimum  
**Mechanical Life:** 100,000 operations minimum for On-None-On & On-Off-On  
 50,000 operations minimum for other circuits  
**Electrical Life:** 100,000 operations minimum for On-None-On & On-Off-On  
 50,000 operations minimum for other circuits  
**Nominal Operating Force:** 0.93N for momentary & 1.20N for maintained  
**Angle of Throw:** 28°

## Materials & Finishes

**Actuator:** Glass fiber reinforced polyamide  
**Case:** Glass fiber reinforced polyamide  
**Sealing Rings:** Nitrile butadiene rubber  
**Movable Contacts:** Phosphor bronze with gold plating  
**Stationary Contacts:** Phosphor bronze with gold plating  
**Base:** Glass fiber reinforced polyamide  
**Terminals:** Phosphor bronze with gold plating  
**Support Bracket:** Phosphor bronze with tin plating

## Environmental Data

**Operating Temperature Range:** -25°C through +85°C (-13°F through +185°F)  
**Humidity:** 90 ~ 95% humidity for 96 hours @ 40°C (104°F)  
**Vibration:** 10 ~ 55Hz with peak-to-peak amplitude of 1.5mm traversing the frequency range & returning in 1 minute; 3 right angled directions for 2 hours  
**Shock:** 50G (490m/s<sup>2</sup>) acceleration (tested in 6 right angled directions, with 5 shocks in each direction)

## PCB Processing

**Soldering:** Wave Soldering Recommended: See Profile A in Supplement section.  
 Manual Soldering: See Profile A in Supplement section.  
**Cleaning:** Automated cleaning. See Cleaning specifications in Supplement section.

## Standards & Certifications

**UL Recognition or CSA Certification:** The G Series toggles have not been tested for UL recognition or CSA certification. These switches are designed for use in a low-voltage, low-current, logic-level circuit. When used as intended in a logic-level circuit, the results do not produce hazardous energy.

### TYPICAL SWITCH ORDERING EXAMPLE





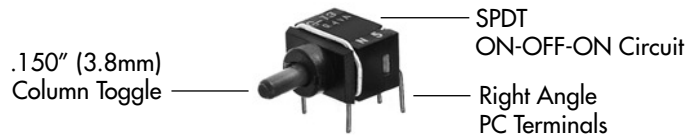

<b>G</b>	<b>1</b>	<b>3</b>	<b>A</b>	<b>H</b>
<b>POLES</b>	<b>CIRCUITS</b>		<b>ACTUATOR</b>	<b>PC TERMINALS</b>
<b>1</b>   SPDT	<b>2</b>   ON   NONE   ON	<b>3</b>   ON   OFF   ON	<b>A</b>   .150" (3.8mm) Column Toggle	<b>P</b>   Straight
<b>2</b>   DPDT	<b>5</b>   ON   NONE   (ON)	<b>8</b>   (ON)   OFF   (ON)		<b>H</b>   Right Angle
	<b>9</b>   ON   OFF   (ON)			<b>V</b>   Vertical
	( ) = Momentary			

### DESCRIPTION FOR TYPICAL ORDERING EXAMPLE

#### G13AH

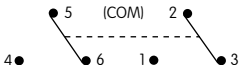

### POLES & CIRCUITS

Pole	Model	Toggle Position ( ) = Momentary			Connected Terminals			Throw & Schematics
		Up 	Center 	Down 	Up 	Center 	Down 	
SP	G12 G13 G15 G18 G19	ON ON ON (ON) ON	NONE OFF NONE OFF OFF	ON ON (ON) (ON) (ON)	5-6	OPEN	5-4	SPDT 
DP	G22 G23 G25 G28 G29	ON ON ON (ON) ON	NONE OFF NONE OFF OFF	ON ON (ON) (ON) (ON)	5-6 2-3	OPEN	5-4 2-1	DPDT 

### ACTUATOR

**A** .150" (3.8mm) Column Toggle

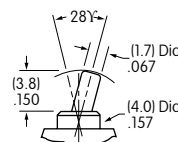

### PC TERMINALS

**P** Straight

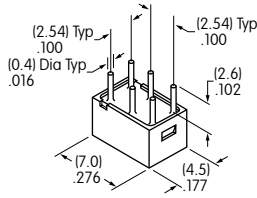

**H** Right Angle

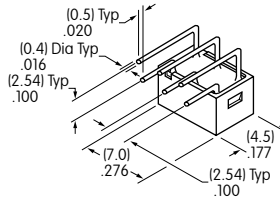

**V** Vertical

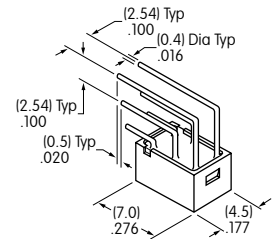

### TYPICAL SWITCH DIMENSIONS

**Straight PC**



**G19AP**

**Single & Double Pole**

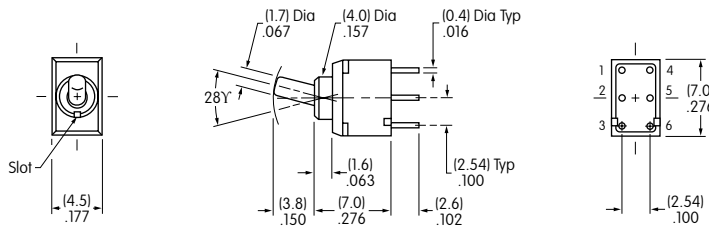

On single pole models, locations 1 & 3 are for support pins.

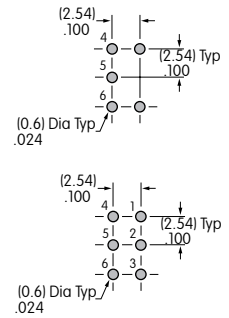

**Right Angle PC**



**G19AH**

**Single & Double Pole**

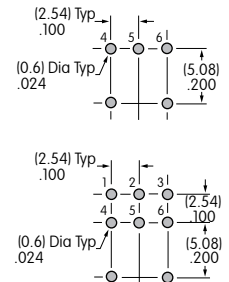
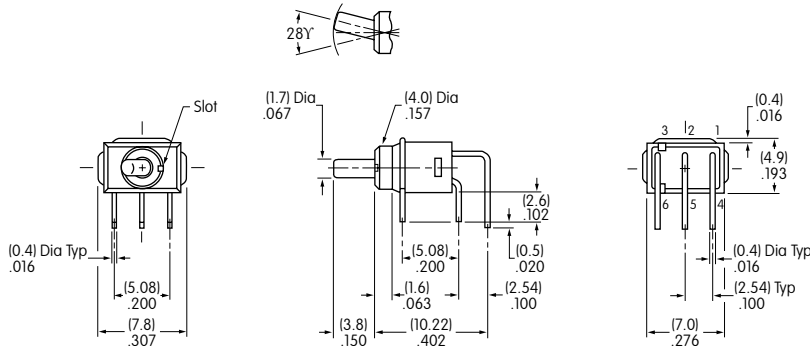

**Vertical PC**



**G22AV**

**Single & Double Pole**

