HD74HCU04A

Hex Inverters

HITACHI

ADE-205-288 (Z)
1st. Edition
June 1999

Description

The HD74HCU04A has six inverters in a 14 pin package. $Y = \bar{A}$

Features

- $V_{CC} = 4.5$ to 5.5 V operation
- Input terminal has protection diode

Function Table

Input A	Output Y
H	L
L	H

H : High level

L : Low level

Pin Arrangement

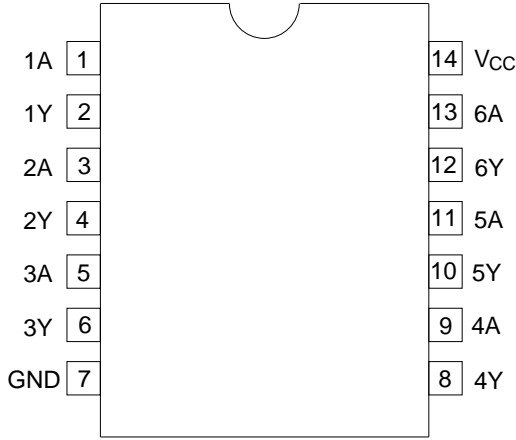

(Top view)

Absolute Maximum Ratings

Item	Symbol	Ratings	Unit
Supply voltage	V _{CC}	-0.5 to 7.0	V
Input diode peak current	I _{IK}	±20	mA
Output diode peak current	I _{OK}	±20	mA
Output current	I _O	±25	mA
V _{CC} , GND current / pin	I _{CC} or I _{GND}	±50	mA
Storage temperature	T _{stg}	-65 to 150	°C

Recommended Operating Conditions

Item	Symbol	V _{CC} (V)	Min	Typ	Max	Unit
Supply voltage	V _{CC}		2.0	5.0	6.0	V
Input voltage	V _{IH}	2.0	1.7	—	—	V
		4.5	3.6	—	—	
		6.0	4.8	—	—	
	V _{IL}	2.0	0	—	0.3	
		4.5	0	—	0.8	
		6.0	0	—	1.1	
		V _I		0	—	V _{CC}
Output voltage	V _O		0	—	V _{CC}	V
Output current	I _{OH}	4.5	—	-4.0	—	mA
		6.0	—	-5.2	—	
	I _{OL}	4.5	—	4.0	—	
		6.0	—	5.2	—	
Input rise / fall time	t _r , t _f	2.0	0	—	1000	ns
		4.5	0	—	500	
		6.0	0	—	400	
Operating temperature	T _a		-40	—	85	°C

Logic Diagram (1/4 Circuit)

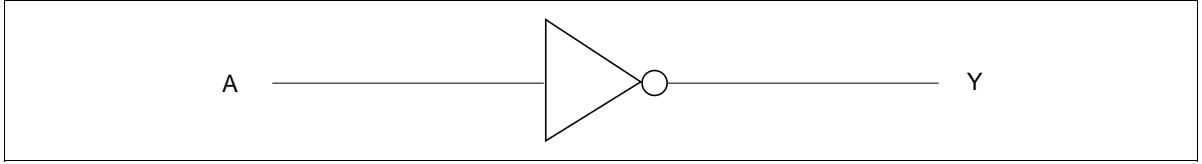

Electrical Characteristics

Item	Symbol	V_{CC} (V)	$T_a = 25^\circ\text{C}$			$T_a = -40 \text{ to } 85^\circ\text{C}$		Unit	Test Conditions	
			Min	Typ	Max	Min	Max			
Output voltage	V_{OH}	2.0	1.80	—	—	1.80	—	V	$I_o = -20 \mu\text{A}$	
		4.5	4.00	—	—	4.00	—			
		6.0	5.50	—	—	5.50	—			
		4.5	3.86	—	—	3.76	—			$I_o = -4 \text{ mA}$
		6.0	5.36	—	—	5.26	—			$I_o = -5.2 \text{ mA}$
		6.0	—	—	0.20	—	0.20			$I_o = 20 \mu\text{A}$
	V_{OL}	4.5	—	—	0.50	—	0.50	nA	$V_i = V_{CC} \text{ or GND}$	
		6.0	—	—	0.50	—	0.50			
		4.5	—	—	0.32	—	0.37			$I_o = 4 \text{ mA}$
		6.0	—	—	0.32	—	0.37			$I_o = 5.2 \text{ mA}$
Input current	I_i	6.0	—	± 0.1	± 100	—	± 1000	nA	$V_i = V_{CC} \text{ or GND}$	
Quiescent supply voltage	I_{CC}	6.0	—	—	2.0	—	20	μA	$V_i = V_{CC} \text{ or GND}, I_o = 0$	

Switching Characteristics ($C_L = 50 \text{ pF}$)

Item	Symbol	$V_{CC} \text{ (V)}$	$T_a = 25^\circ\text{C}$			$T_a = -40 \text{ to } 85^\circ\text{C}$		Unit	Input FROM	Output TO
			Min	Typ	Max	Min	Max			
Propagation delay time	t_{PLH}	2.0	—	16	60	—	75	ns	A	Y
	t_{PHL}	4.5	—	7	12	—	15			
		6.0	—	6	10	—	13			
Output rise / fall time	t_r	2.0	—	21	75	—	95	ns		Each
	t_f	4.5	—	8	15	—	19			output
		6.0	—	7	13	—	16			
Input capacitance	C_I	—	—	3	10	—	10	pF		
Power dissipation capacitance	C_{PD}	—	—	20	—	—	—	pF		

Test Circuit

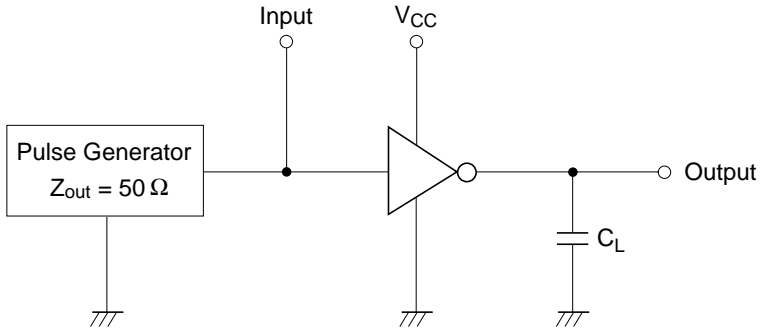

Note: 1. C_L includes probe and jig capacitance.

• Waveform

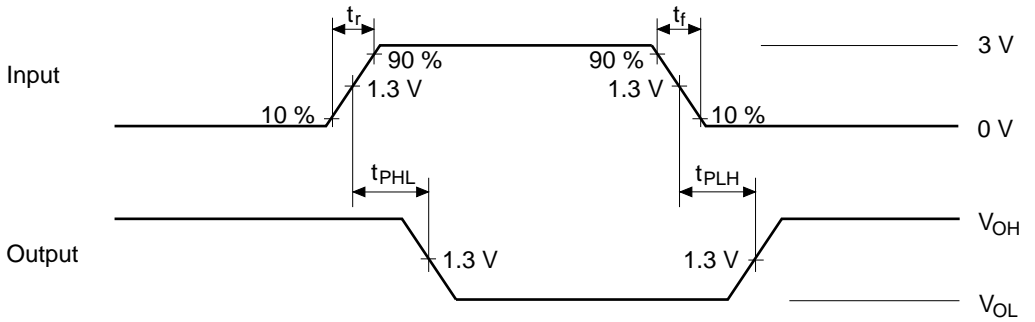

Note: 1. Input waveform : PRR = 1 MHz, duty cycle 50%, $t_r = 6$ ns, $t_f = 6$ ns

Package Dimensions

Unit : mm

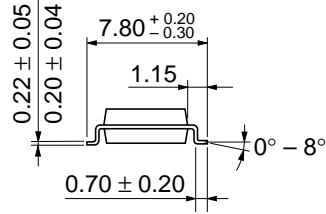
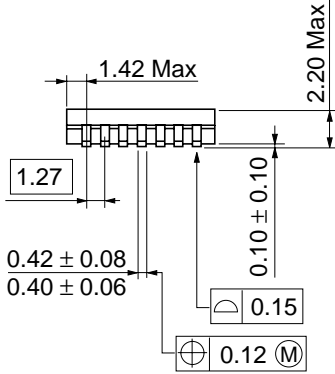
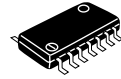
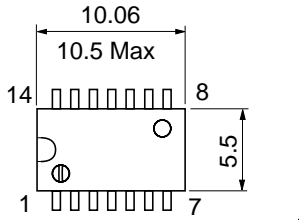

Dimension including the plating thickness
Base material dimension

Hitachi Code	FP-14DA
JEDEC	—
EIAJ	Conforms
Weight (reference value)	0.23 g

HD74HCU04A

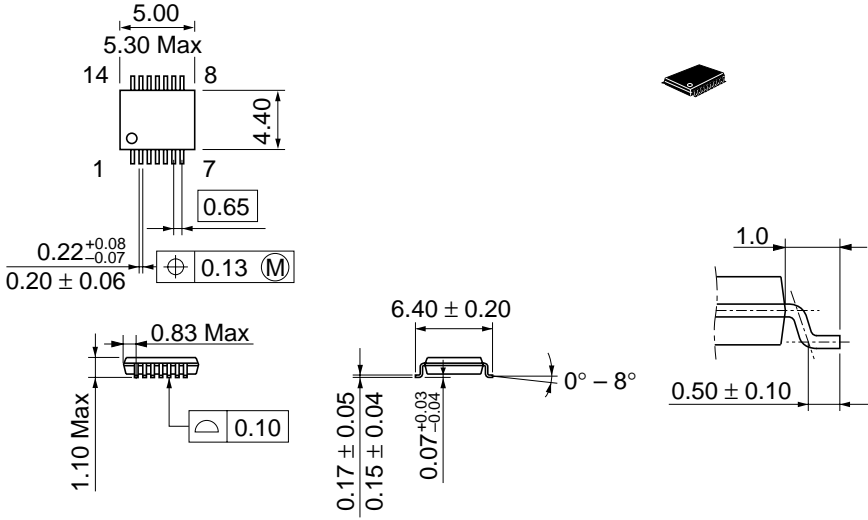

Dimension including the plating thickness
Base material dimension

Hitachi Code	TTP-14D
JEDEC	—
EIAJ	—
Weight (reference value)	0.05 g

Cautions

1. Hitachi neither warrants nor grants licenses of any rights of Hitachi's or any third party's patent, copyright, trademark, or other intellectual property rights for information contained in this document. Hitachi bears no responsibility for problems that may arise with third party's rights, including intellectual property rights, in connection with use of the information contained in this document.
2. Products and product specifications may be subject to change without notice. Confirm that you have received the latest product standards or specifications before final design, purchase or use.
3. Hitachi makes every attempt to ensure that its products are of high quality and reliability. However, contact Hitachi's sales office before using the product in an application that demands especially high quality and reliability or where its failure or malfunction may directly threaten human life or cause risk of bodily injury, such as aerospace, aeronautics, nuclear power, combustion control, transportation, traffic, safety equipment or medical equipment for life support.
4. Design your application so that the product is used within the ranges guaranteed by Hitachi particularly for maximum rating, operating supply voltage range, heat radiation characteristics, installation conditions and other characteristics. Hitachi bears no responsibility for failure or damage when used beyond the guaranteed ranges. Even within the guaranteed ranges, consider normally foreseeable failure rates or failure modes in semiconductor devices and employ systemic measures such as fail-safes, so that the equipment incorporating Hitachi product does not cause bodily injury, fire or other consequential damage due to operation of the Hitachi product.
5. This product is not designed to be radiation resistant.
6. No one is permitted to reproduce or duplicate, in any form, the whole or part of this document without written approval from Hitachi.
7. Contact Hitachi's sales office for any questions regarding this document or Hitachi semiconductor products.

HITACHI

Hitachi, Ltd.

Semiconductor & Integrated Circuits.
Nippon Bldg., 2-6-2, Ohte-machi, Chiyoda-ku, Tokyo 100-0004, Japan
Tel: Tokyo (03) 3270-2111 Fax: (03) 3270-5109

URL North America : <http://semiconductor.hitachi.com/>
 Europe : <http://www.hitachi-eu.com/hel/ecg>
 Asia (Singapore) : <http://www.has.hitachi.com.sg/grp3/sicd/index.htm>
 Asia (Taiwan) : http://www.hitachi.com.tw/E/Product/SICD_Frame.htm
 Asia (HongKong) : <http://www.hitachi.com.hk/eng/bo/grp3/index.htm>
 Japan : <http://www.hitachi.co.jp/Sicd/indx.htm>

For further information write to:

Hitachi Semiconductor
(America) Inc.
179 East Tasman Drive,
San Jose, CA 95134
Tel: <1> (408) 433-1990
Fax: <1> (408) 433-0223

Hitachi Europe GmbH
Electronic components Group
Dornacher Straße 3
D-85622 Feldkirchen, Munich
Germany
Tel: <49> (89) 9 9180-0
Fax: <49> (89) 9 29 30 00

Hitachi Europe Ltd.
Electronic Components Group.
Whitebrook Park
Lower Cookham Road
Maidenhead
Berkshire SL6 8YA, United Kingdom
Tel: <44> (1628) 585000
Fax: <44> (1628) 778322

Hitachi Asia Pte. Ltd.
16 Collyer Quay #20-00
Hitachi Tower
Singapore 049318
Tel: 535-2100
Fax: 535-1533

Hitachi Asia Ltd.
Taipei Branch Office
3F, Hung Kuo Building, No.167,
Tun-Hwa North Road, Taipei (105)
Tel: <886> (2) 2718-3666
Fax: <886> (2) 2718-8180

Hitachi Asia (Hong Kong) Ltd.
Group III (Electronic Components)
7/F., North Tower, World Finance Centre,
Harbour City, Canton Road, Tsim Sha Tsui,
Kowloon, Hong Kong
Tel: <852> (2) 735 9218
Fax: <852> (2) 730 0281
Telex: 40815 HITEC HX

Copyright ' Hitachi, Ltd., 1999. All rights reserved. Printed in Japan.

HITACHI