

SILICON BRIDGE RECTIFIERS	REVERSE VOLTAGE - 50 to 1000Volts FORWARD CURRENT - 10 Amperes
----------------------------------	---

FEATURES

- Rating to 1000V PRV
- Ideal for printed circuit board
- Low forward voltage drop, high current capability
- Reliable low cost construction utilizing molded plastic technique results in inexpensive product
- The plastic material has UL flammability classification 94V-0

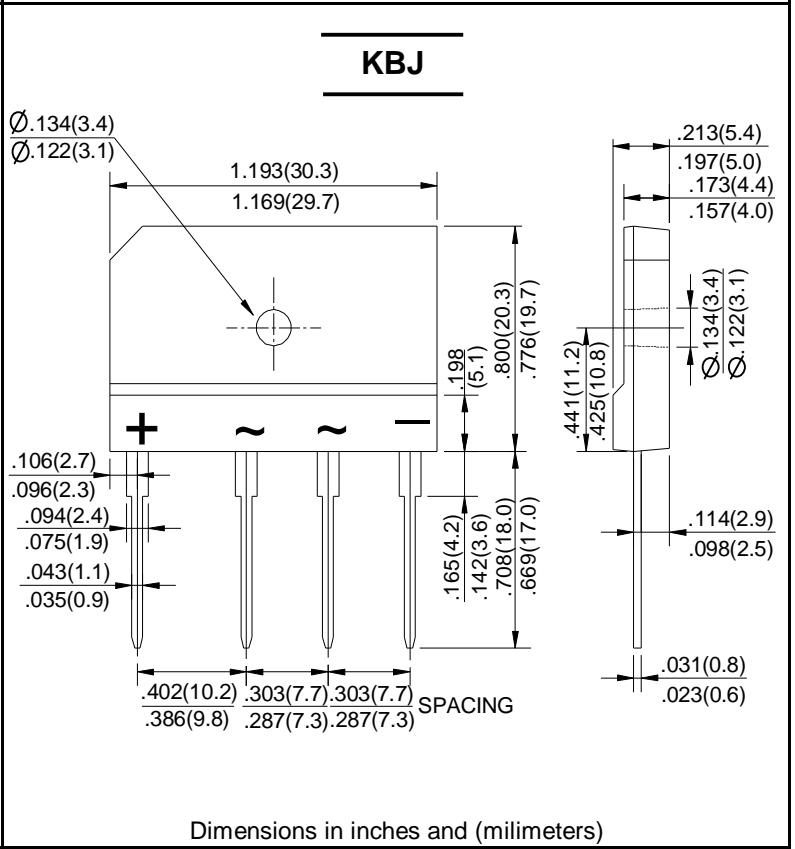

MAXIMUM RATINGS AND ELECTRICAL CHARACTERISTICS

Rating at 25°C ambient temperature unless otherwise specified.
 Single phase, half wave ,60Hz, resistive or inductive load.
 For capacitive load, derate current by 20%

CHARACTERISTICS	SYMBOL	KBJ 10005	KBJ 1001	KBJ 1002	KBJ 1004	KBJ 1006	KBJ 1008	KBJ 1010	UNIT	
Maximum Recurrent Peak Reverse Voltage	V _{RRM}	50	100	200	400	600	800	1000	v	
Maximum RMS Voltage	V _{RMS}	30	70	140	280	420	560	700	v	
Maximum DC Blocking Voltage	V _{DC}	50	100	200	400	600	800	1000	v	
Maximum Average Forward Rectified Current @ T _c =110°C (without heatsink)	I _(AV)	10.0								A
Peak Forward Surge Current 8.3ms Single Half Sine-Wave Super Imposed on Rated Load (JEDEC Method)	I _{FSM}	3.0								A
Maximum Forward Voltage at 5.0A DC	V _F	240								V
Maximum DC Reverse Current at Rated DC Blocking Voltage @ T _J =25°C @ T _J =125°C	I _R	1.0								uA
I ² t Rating for Fusing (t<8.3ms)	I ² t	500								A ² s
Typical Junction Capacitance Per Element (Note1)	C _J	120								pF
Typical Thermal Resistance (Note2)	R _{θJC}	55								°C/W
Operating Temperature Range	T _J	1.4								°C
Storage Temperature Range	T _{STG}	-55 to +125								°C

NOTES: 1. Measured at 1.0MHz and applied reverse voltage of 4.0V DC.
 2. Device mounted on 150mm*150mm*1.6mm cu plate heatsink.

FIG.1-FORWARD CURRENT DERATING CURVE

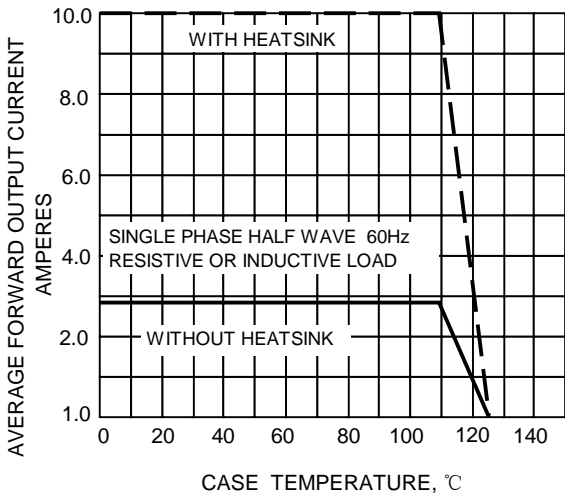

FIG.2-MAXMUN NON-REPETITIVE SURGE CURRENT

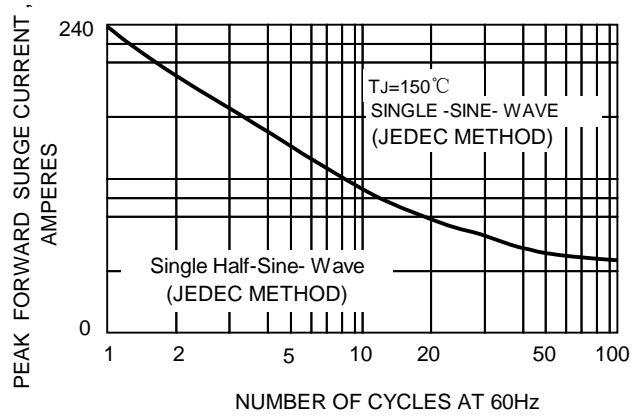

FIG.3-TYPICAL JUNCTION CAPACITANCE

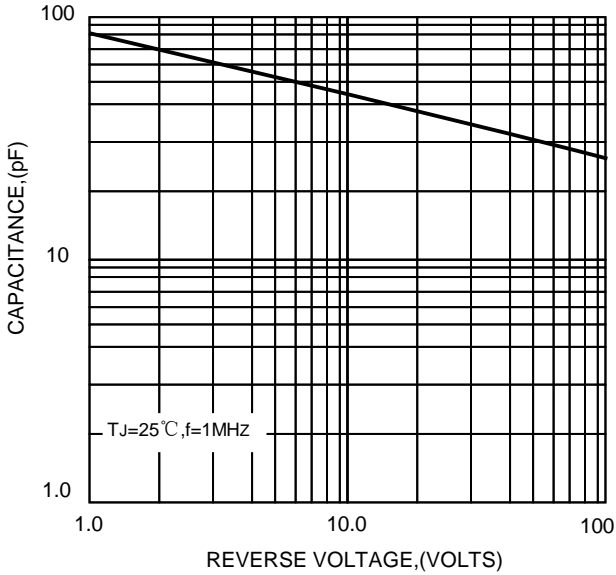

FIG.4-TYPICAL FORWARD CHARACTERISTICS

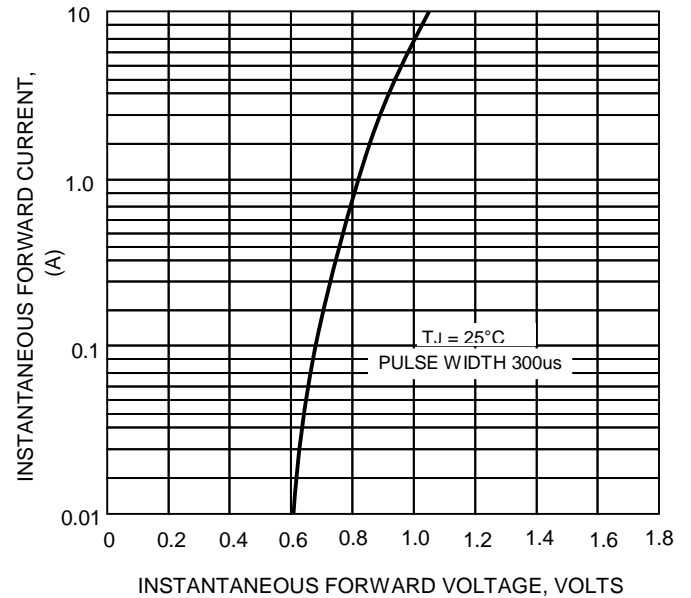

FIG.5-TYPICAL REVERSE CHARACTERISTICS

