



KHS



KHAU

# KHA series

## General Purpose Dry Circuit to 5A Multicontact AC or DC Relay

File E22575

File LR15734

### Features

- Miniature size from 2 pole to 4 pole.
- KHAU is produced on an automated line, while KHU is produced manually. Form, fit and function of the two versions are identical.
- KHS hermetically sealed version UL Approved for Class 1 Division 2 hazardous locations.
- Various applications include process control, photocopier, and data processing.
- Push-to-test and indicator options available.
- Various contact materials available for specific load requirements.

### Contact Data @ 25°C

**Arrangements:** 2 Form C (DPDT), 4 Form C (4PDT).

**Expected Life:** 10 million operations, mechanical; 100,000 operations min. at rated loads. Ratings are based on tests of relays with ungrounded frames.

**Initial Breakdown Voltage:** 500V rms, 60 Hz., between open contacts.  
1240V rms, 60 Hz., between all other elements.

### Coil Data @ 25°C

**Voltage:** From 6 to 120VDC, and 6 to 240VAC, 50/60 Hz.

**Nom. Power:** DC coils - 0.9 watt; 0.5 watt minimum operate @ 25°C.

AC coils - 1.2 VA; 0.55 VA minimum operate @ 25°C.

**Max. Power:** DC coils - 2.0 watts @ 25°C.

**Duty Cycle:** Continuous.

**Initial Breakdown Voltage:** 500V rms, 60 Hz.

### Coil Data

Nominal Voltage	DC Coils		AC Coils	
	Resistance in Ohms ±10% @ 25°C	Nominal Inductance in Henrys	Resistance in Ohms ±15%	Nominal AC Current in mA
5	32	.072	—	—
6	40	.08	10.5	200
12	160	.28	43	100
24	650	1.0	160	52
48	2,600	4.5	668	25
110 *	11,000	17.0	—	—
120 *	—	—	3,900	11.0
240	—	—	12,000	6.0

\*Note: For 220 and 240VDC, use series dropping 5W resistor of 11,000Ω.

### Contact Ratings

Contact Code	Material	Resistive Rating	
		Minimum	Maximum
1	Silver	100mA @ 12VAC/12VDC	3A @ 120VAC/28VDC
2*	Silver-cadmium oxide	500mA @ 12VAC/12VDC	5A @ 120VAC/28VDC
3	Gold-silver-nickel	10mA @ 12VAC/12VDC	2A @ 120VAC/28VDC
6	Bifurcated cross bar, gold overlay silver	Dry circuit	1A @ 120VAC/28VDC
8	Gold diffused silver	50mA @ 12VAC/12VDC	3A @ 120VAC/28VDC

Note: Relays should only carry a maximum of 15 amps continuously for all poles combined.

### KHS Contact Ratings

**Class I Division II Hazardous Location:**

5A@28VDC/120VAC

**UL 508 (Industrial Control):**

3A@28VDC/120VAC; 1/10 HP @ 120VAC.

### Operate Data @ 25°C

**Must-Operate Voltage:** DC: 75% of nominal voltage.

AC: 85% of nominal voltage.

**Operate Time:** 13 milliseconds typical @ nominal voltage (excluding bounce).

**Release Time:** 6 milliseconds typical @ nominal voltage (excluding bounce).

### Environmental Data

**Temperature Range:** -45°C to +70°C operate.

-60°C to +130°C storage.

### Mechanical Data

**Mountings:** #3-48 stud, sockets with printed circuit or solder terminals, or bracket plate with #6-32 threaded stud.

**Termination:** Printed circuit or solder/socket terminals.

Printed circuit terminals are available for KHS on a special order basis.

**Enclosures:** See Ordering Information table.

**Weight:** 1.6 oz. approx. (45g).

Ordering Information

Typical Part No. ►

KHA

U

-17

A

1

1

B

-24

1. Basic Series: (See Note 1)

2. Type:

E = Printed circuit terminals, nylon dust cover, contacts rated opposite polarity (UL & CSA).  
 S = Solder terminals, hermetically sealed steel case (UL & CSA). Note: Do not ground KHS frame without consulting factory for load levels. (Order as KHS, not KHAS.)  
 U = Solder terminals, clear polycarbonate dust cover, contacts rated same polarity (UL & CSA).

3. Contact Arrangement:

11 = 2 Form C (DPDT)  
 17 = 4 Form C (4PDT)

4. Operating Coil:

A = AC D = DC

5. Mounting and Termination:

1 = Socket mount, solder terminals on S, U types; printed circuit terminals on E types.

6. Contact Material:

Relay Type	E	S	U
Available Codes	1, 2, 3, 6, 8	1*, 2*, 3	1, 2, 6, 8

\*UL Rated 1/10 HP, 3A, 120VAC when used with mounting & termination 1.

1 = Silver.

3 = Gold-silver-nickel.

8 = Gold diffused silver.

2 = Silver-cadmium oxide.

6 = Bifurcated crossbar, gold overlay silver.

7. Options Available:

Relay Type	E	S	U
Available Codes	B (DPDT only)	None	N B H L M

B = Push to test button.

N = Neon indicator. Only available with 120VAC or 110VDC coils. Not available with mounting & termination 4 or 8.

H = Neon indicator and push to test button. Only available with 120VAC or DC coils. Not available with mounting & termination 4 or 8.

L = LED indicator. Only available with 6-48VDC coils.

M = LED indicator and push-to-test button. Only available with 6-48VDC coils.

8. Coil Voltage:

6, 12, 24, 48, 120, 240\*\*VAC

6, 12, 24, 48, 110VDC

\*\*240VAC coil is not available on KHS type relays.

Note 1: Some KHA models available in KH construction. Specify KH instead of KHA.

Stock Items - The following items are normally maintained in stock for immediate delivery.

KHAE-17D12-24	KHAU-17D11-24	KHS-17D11-48
KHAU-11A11-120	KHAU-17D11-48	KHS-17D11-110
KHAU-11D11-24	KHAU-17D11-110	KHS-17D12-12
KHAU-17A11-12	KHAU-17D12-12	KHS-17D12-24
KHAU-17A11-24	KHAU-17D12-24	
KHAU-17A11-120	KHAU-17D12-48	
KHAU-17A11N-120	KHAU-17D12-110	
KHAU-17A12-120	KHAU-17D16-12	
KHAU-17A13-120	KHAU-17D16-24	
KHAU-17A16-24	KHS-17A11-24	
KHAU-17A16-120	KHS-17A11-120	
KHAU-17A18-120	KHS-17A12-120	
KHAU-17D11-6	KHS-17D11-12	
KHAU-17D11-12	KHS-17D11-24	

**Outline Dimensions**

**Mounting Code 1 - KHAU only.**

**2 & 4 Pole**

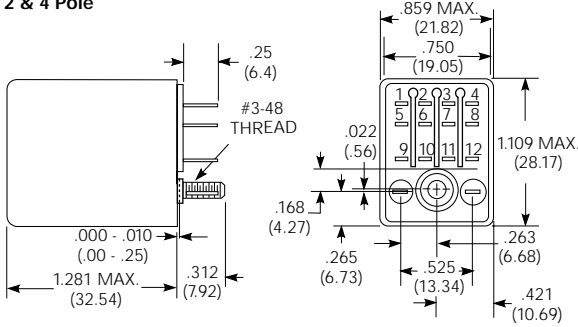

PC terminal models have rivet, not stud.  
Max. seated height in 27E006 socket is 1.37" (34.8mm).

**Mounting Code 1 - KHS only.**

**2 & 4 Pole**

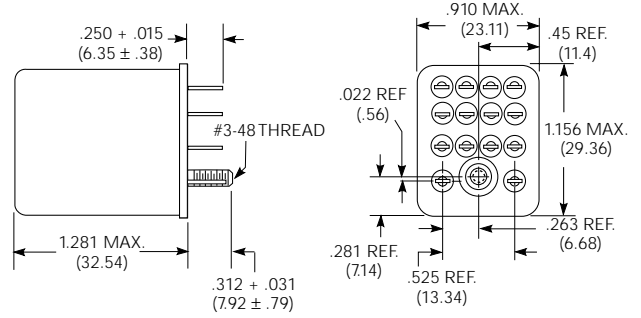

Class 1 Div. 2 Group A, B, C & D Hazards

**Mounting Code 1 - Neon Indicator, Push-To-Test.**

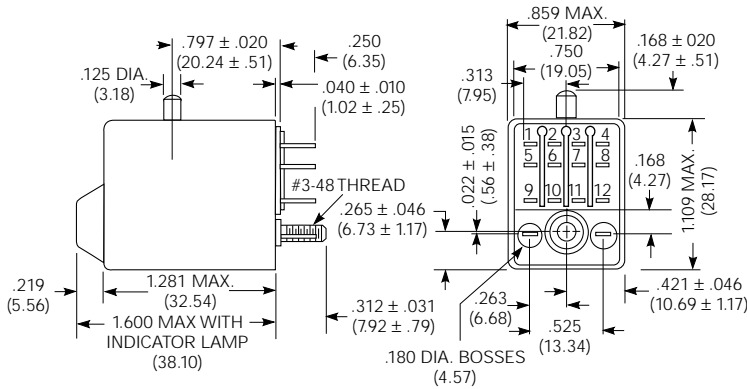

**Printed Circuit Terminals**

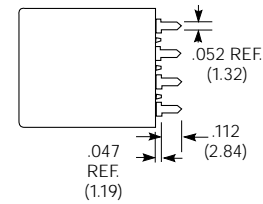

Printed circuit terminal thickness .022 (.558)

**Wiring Diagrams (Bottom Views)**

**2 Pole**

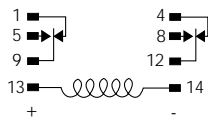

**4 Pole**

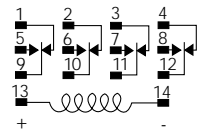

+ = Polarity for LED indicator.

**PC Board Layout (Bottom View)**

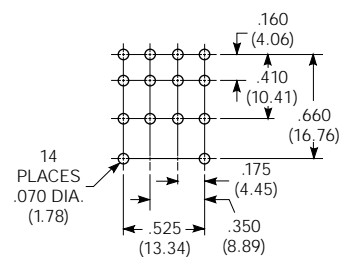

For KHA/E Relays with PC terminals and sockets with PC terminals

**Sockets For KHA And KHS Series**

All sockets are normally maintained in stock for immediate delivery.

For KHAU, KHAX, KHS Relays.

Relays with solder terminals are required for use with sockets.

**Socket Description**

Industrial Part No.	No. of Poles	Terminal and Length	Grounding Provision	Socket Material
27E006*	4	Solder .375" (9.53mm)	Yes	Nylon
27E007*	4	P.C. .218" (5.54mm)	Yes	Nylon
27E023*	4	P.C. .218" (5.54mm)	No	Nylon
27E220*	2	P.C. .218" (5.54mm)	No	Nylon
27E166**	4	Screw	Yes	Glass-filled Polyester
27E894**	4	Screw	No	Glass-filled Polyester
20C217 20C297		Relay Hold Down Spring Relay Hold Down Spring (use with 27E166 & 27E894)		

\* UL Recognized, file E22575  
\*\* UL Recognized, file E59244

**Pierced Solder Terminals**

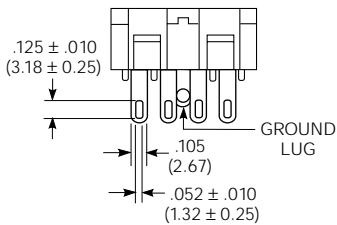

**Mounting Strip 37D633**

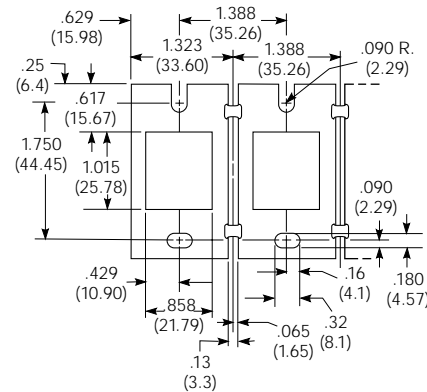

37D633 will mount eight solder terminal sockets in one length of aluminum strip measuring 10.97" x 2.25" x .062 (278.6 x 57.15 x 1.57)

**Screw Terminal Socket 27E166**

Relays with solder terminals are required for use with screw terminal sockets.

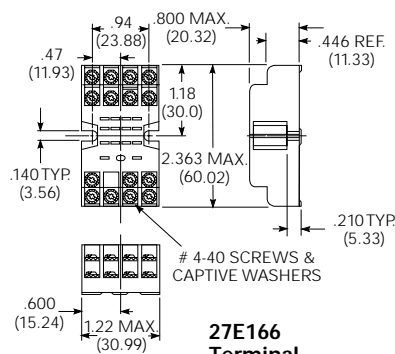

**27E166 Terminal Location**

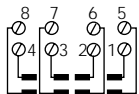

**Top View**

**Screw Terminal DIN Rail, Snap-Mount Socket 27E894**

(Use with mounting track 24A110)

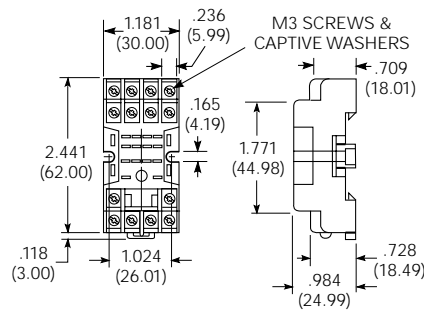

**27E894 Terminal Location**

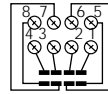

**Top View**

**4-Pole Socket**

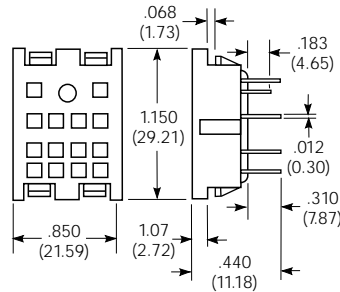

**Recommended Chassis Cutouts For Mounting Sockets**

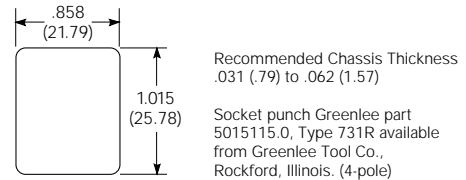

**Printed Circuit Terminals With Grounding Lug**

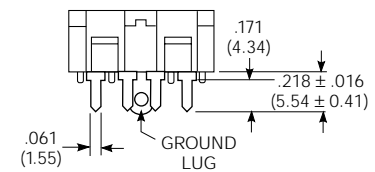

**Without Grounding Lug**

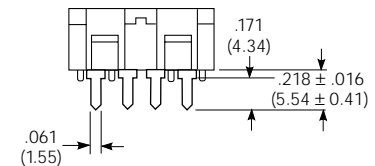

**Caution:** Printed circuit sockets are manufactured with "floating" (Loose) terminals. This permits them to align with holes in the circuit board and with the relay terminals. During the mounting and soldering of the socket, vertical float should be eliminated and the terminals seated on the board. (This may be accomplished by inserting a dummy relay in the socket.) Failure to eliminate float may cause fracture of the solder joint or separation of the copper conductor from the printed circuit board when a relay is inserted in the socket after soldering.

**Hold Down Spring 20C217**

