



CHENMKO ENTERPRISE CO.,LTD

Lead free devices

SINGLE-PHASE GLASS PASSIVATED SILICON BRIDGE RECTIFIER

VOLTAGE RANGE 50 - 1000 Volts CURRENT 25.0 Amperes

KBPC25005PT

THRU

KBPC2510PT

FEATURES

- * Superior thermal design
- * 300 amperes surge rating
- * 1/4" universal faston terminal
- * Hole thru for # 8 screw

MECHANICAL DATA

Case: JEDEC KBPC-25 molded plastic
Terminals: Plated leads solderable per MIL-STD-750, Method 2026
Mounting position: Any
Polarity: Polarity symbols marked on body

MAXIMUM RATINGS AND ELECTRICAL CHARACTERISTICS

Ratings at 25°C ambient temperature unless otherwise specified.
 Single phase, half wave, 60 Hz, resistive or inductive load.
 For capacitive load, derate current by 20%.

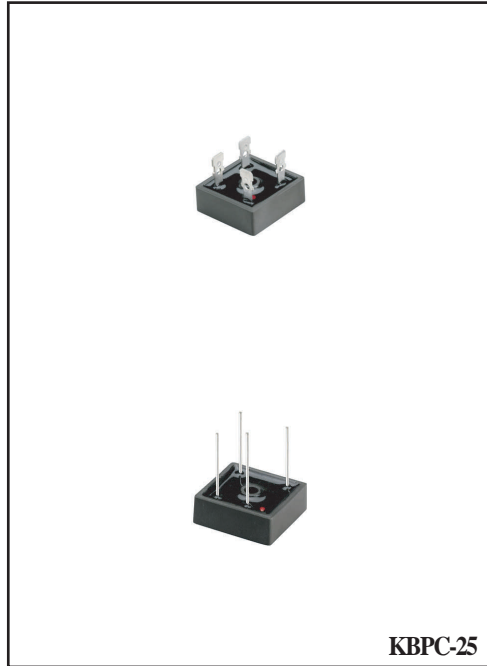

KBPC-25

MAXIMUM RATINGS (At TA = 25°C unless otherwise noted)

RATINGS	SYMBOL	KBPC2501PT	KBPC25005PT	KBPC2502PT	KBPC2504PT	KBPC2506PT	KBPC2508PT	KBPC2510PT	UNITS
Maximum Recurrent Peak Reverse Voltage	VRRM	50	100	200	400	600	800	1000	Volts
Maximum RMS Voltage	VRMS	35	70	140	280	420	560	700	Volts
Maximum DC Blocking Voltage	Vdc	50	100	200	400	600	800	1000	Volts
Maximum Average Forward Rectified Current at Tc = 55°C	Io	25.0							Amps
Peak Forward Surge Current 8.3 ms single half sine-wave superimposed on rated load (JEDEC method)	IFSM	300							Amps
Operating and Storage Temperature Range	Tj,Tstg	-55 to +150							°C

ELECTRICAL CHARACTERISTICS (At TA = 25°C unless otherwise noted)

CHARACTERISTICS	SYMBOL	KBPC2501PT	KBPC25005PT	KBPC2502PT	KBPC2504PT	KBPC2506PT	KBPC2508PT	KBPC2510PT	UNITS
Maximum Instantaneous Forward Voltage at 12.5 A DC	VF	1.1							Volts
Maximum Reverse Current at rated	IR	10							uAmps
DC blocking Voltage per element		0.5							mAmps

RATING CHARACTERISTIC CURVES (KBPC25005PT THRU KBPC2510PT)

FIG. 1 - TYPICAL FORWARD CURRENT DERATING CURVE

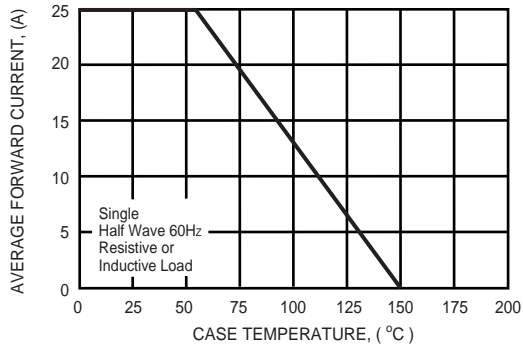

FIG. 2 - MAXIMUM NON-REPETITIVE FORWARD SURGE CURRENT

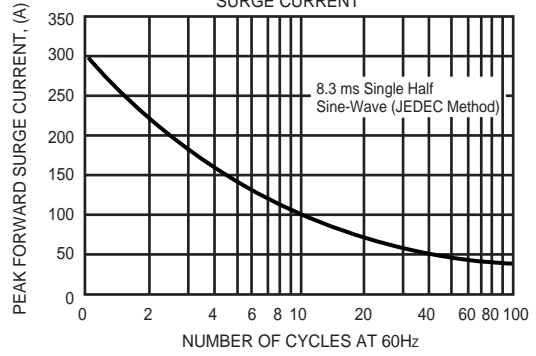

FIG. 3 - TYPICAL INSTANTANEOUS FORWARD CHARACTERISTICS

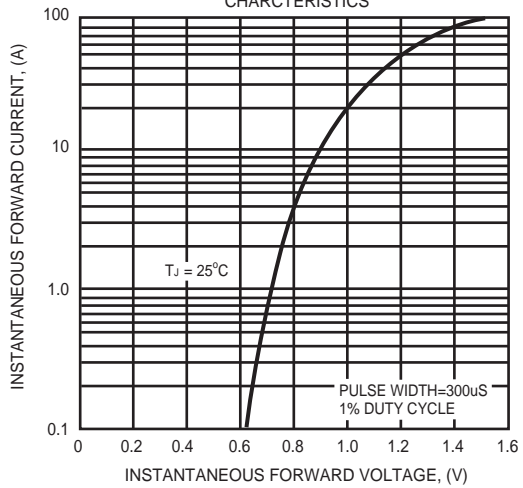
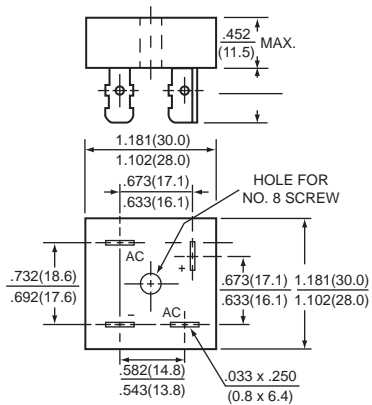
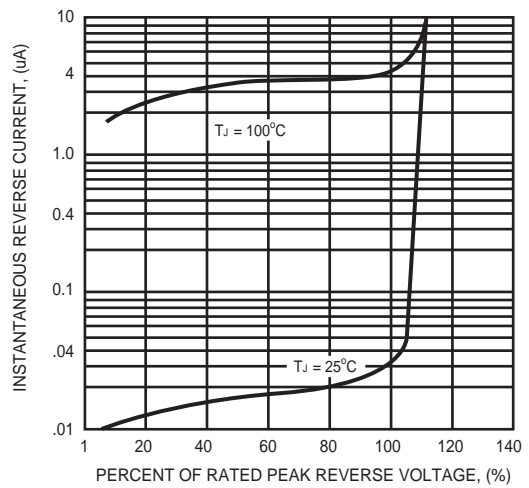
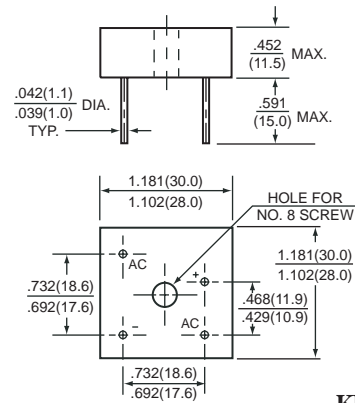

FIG. 4 - TYPICAL REVERSE CHARACTERISTICS



KBPC-25



KBPC-25W