

#### DESCRIPTION:

The KW2-502 series is 0.50 inch (12.70mm) height dual digit display with right DPs designed for viewing distances of up to six meters. This series is suitable for use in instruments, point of sales terminals and electrical appliances. All devices are available as either common anode or common cathode.

#### ABSOLUTE MAXIMUM RATINGS: (Ta=25°C)

Parameter	Max
Reverse Voltage per segment	5 V
Reverse Current per segment (Vr = 5V)	100μA
Derating Linear from 25°C per segment	0.4mA/°C
Operating Temperature Range	-40°C To 85°C
Storage Temperature Range	-40°C To 100°C
Soldering Temperature 1.6mm(1/16") from body for 5 sec. at 260°C	

- NOTES : 1. All dimensions are in millimeters (inches).  
 2. Tolerance is ±0.25mm(0.010) unless otherwise specified.  
 3. Specifications are subject to change without notice.  
 4. NP: No Pin.  
 5. NC: No Connect.

#### TESTING CONDITION FOR EACH PARAMETER :

Parameter	Symbol	Unit	Test Condition
Forward Voltage	Vf	V	If=20mA
Peak Emission Wave Length	λp	nm	If=20mA
Spectral Line Half-Width	Δλ	nm	If=20mA
Reverse Current	Ir	μA	Vr=5V
Average Luminous Intensity	Iv	μ cd	If=10mA

#### PACKAGE DIMENSIONS

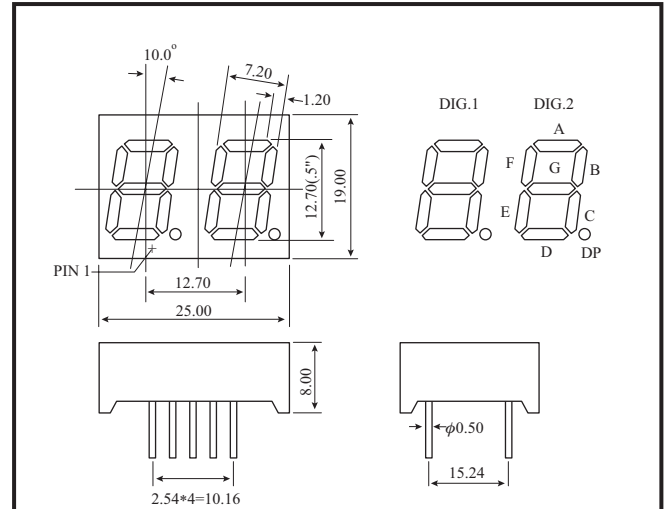

#### INTERNAL CIRCUIT DIAGRAM

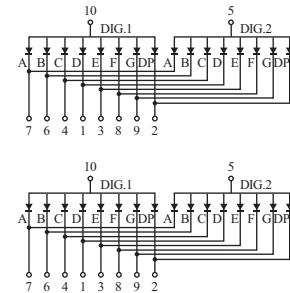

#### PART NO. SELECTION AND APPLICATION INFORMATION (RATINGS AT 25°C AMBIENT)

Part No.	Chip		C.C or C.A	Wave Length λp (nm)	Absolute Maximum Ratings				Electro-optical Data(at 10mA)					
	Raw Material	Emitted Color			Δλ (nm)	Pd (mW)	If (mA)	If (Peak) (mA)	Vf (V) Per Segment			If (Rec) (mA)	Iv (μcd) Per Segment	
									Min.	Typ.	Max.		Min.	Typ.
KW2-502A3	GaAsP/GaP	Hi-Eff. Red	Common Anode	635	45	100	50	100	1.7	1.9	2.6	10-20	750	2000
KW2-502AS	GaAlAs	Super Red		660	20	100	50	100	1.5	1.9	2.6	10-20	5600	21000
KW2-502A2	GaP	Green		565	30	100	50	100	1.7	2.2	2.6	10-20	750	2000
KW2-502AG	GaP	Super Green		570	30	100	50	100	1.7	2.2	2.6	10-20	850	2200
KW2-502A6	GaAsP/GaP	Yellow		585	30	100	50	100	1.7	1.9	2.6	10-20	700	1600
KW2-502C3	GaAsP/GaP	Hi-Eff Red	Common Cathode	635	45	100	50	100	1.7	1.9	2.6	10-20	750	2000
KW2-502CS	GaAlAs	Super Red		660	20	100	50	100	1.5	1.9	2.6	10-20	5600	21000
KW2-502C2	GaP	Green		565	30	100	50	100	1.7	2.2	2.6	10-20	750	2000
KW2-502CG	GaP	Super Green		570	30	100	50	100	1.7	2.2	2.6	10-20	850	2200
KW2-502C6	GaAsP/GaP	Yellow		585	30	100	50	100	1.7	1.9	2.6	10-20	700	1600

- REMARKS : 1. The average luminous intensity is obtained by summing the luminous intensity of each segment and dividing by the total number of segments.  
 2. Luminous intensity is measured with a light sensor and filter combination that approximates the CIE (International Commission on Illumination) eye-response curve.  
 3. Clean only by pure water, isopropanol, ethanol, Freon TF (or equivalent).