

General Description

This planar stripe MOSFET has better characteristics, such as fast switching time, fast reverse recovery time, low on resistance, low gate charge and excellent avalanche characteristics. It is mainly suitable for active power factor correction and switching mode power supplies.

FEATURES

- $V_{DSS}=500V$, $I_D=10A$
- Drain-Source ON Resistance :
 $R_{DS(ON)}(Max)=0.65 \Omega$ @ $V_{GS}=10V$
- $Qg(typ.)= 19.5nC$
- $t_{rr}(typ) = 170ns$

MAXIMUM RATING (Tc=25 °C)

CHARACTERISTIC	SYMBOL	RATING		UNIT
		KF10N50PR	KF10N50FR	
Drain-Source Voltage	V_{DSS}	500		V
Gate-Source Voltage	V_{GSS}	±30		V
Drain Current	@T _C =25 °C	10	10*	A
	@T _C =100 °C	5	5*	
	Pulsed (Note1)	I_{DP}	25	
Single Pulsed Avalanche Energy (Note 2)	E_{AS}	300		mJ
Repetitive Avalanche Energy (Note 1)	E_{AR}	14.7		mJ
Peak Diode Recovery dv/dt (Note 3)	dv/dt	4.5		V/ns
Drain Power Dissipation	T _C =25 °C	130	41.5	W
	Derate above 25 °C	1.04	0.33	W/ °C
Maximum Junction Temperature	T_j	150		°C
Storage Temperature Range	T_{stg}	-55 ~ 150		°C
Thermal Characteristics				
Thermal Resistance, Junction-to-Case	R_{thJC}	0.96	3.0	°C/W
Thermal Resistance, Junction-to-Ambient	R_{thJA}	62.5	62.5	°C/W

* : Drain current limited by maximum junction temperature.

PIN CONNECTION

(KF10N50PR, KF10N50FR)

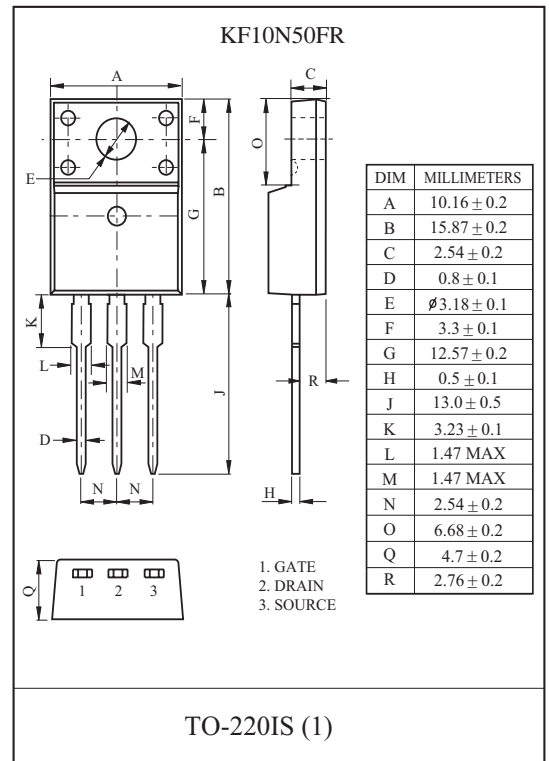
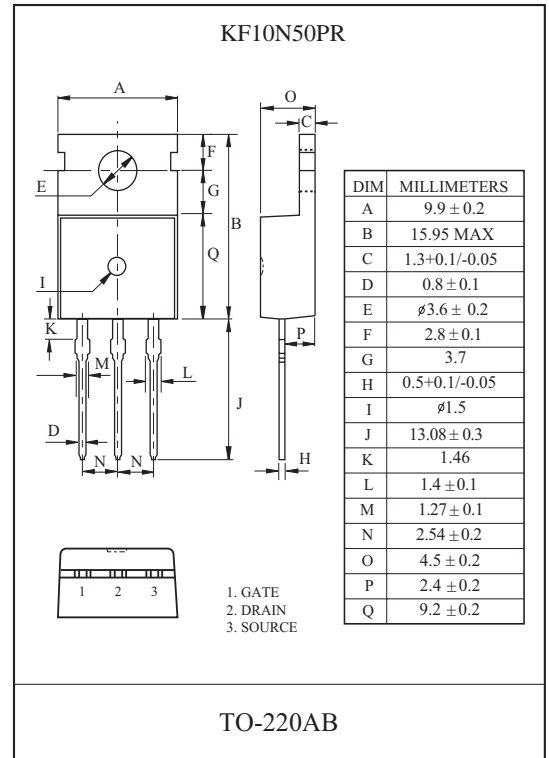
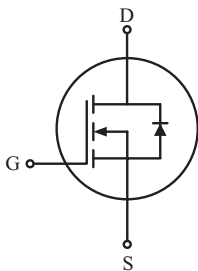

KF10N50PR/FR

ELECTRICAL CHARACTERISTICS (Tc=25 °C)

CHARACTERISTIC	SYMBOL	TEST CONDITION	MIN.	TYP.	MAX.	UNIT
Static						
Drain-Source Breakdown Voltage	BV_{DSS}	$I_D=250\mu A, V_{GS}=0V$	500	-	-	V
Breakdown Voltage Temperature Coefficient	$\Delta BV_{DSS}/\Delta T_j$	$I_D=250\mu A$, Referenced to 25 °C	-	0.6	-	V/ °C
Drain Cut-off Current	I_{DSS}	$V_{DS}=500V, V_{GS}=0V$	-	-	10	μA
Gate Threshold Voltage	V_{th}	$V_{DS}=V_{GS}, I_D=250\mu A$	2	-	4	V
Gate Leakage Current	I_{GSS}	$V_{GS}=\pm 30V, V_{DS}=0V$	-	-	± 100	nA
Drain-Source ON Resistance	$R_{DS(ON)}$	$V_{GS}=10V, I_D=5A$	-	0.54	0.65	Ω
Dynamic						
Total Gate Charge	Q_g	$V_{DS}=400V, I_D=10A$ $V_{GS}=10V$ (Note4,5)	-	19.5	-	nC
Gate-Source Charge	Q_{gs}		-	4.5	-	
Gate-Drain Charge	Q_{gd}		-	8.7	-	
Turn-on Delay time	$t_{d(on)}$	$V_{DD}=250V$ $I_D=10A$ $R_G=25\Omega$ (Note4,5)	-	27	-	ns
Turn-on Rise time	t_r		-	35	-	
Turn-off Delay time	$t_{d(off)}$		-	60	-	
Turn-off Fall time	t_f		-	29	-	
Input Capacitance	C_{iss}	$V_{DS}=25V, V_{GS}=0V, f=1.0MHz$	-	880	-	pF
Reverse Transfer Capacitance	C_{rss}		-	12	-	
Output Capacitance	C_{oss}		-	133	-	
Source-Drain Diode Ratings						
Continuous Source Current	I_S	$V_{GS}<V_{th}$	-	-	10	A
Pulsed Source Current	I_{SP}		-	-	40	
Diode Forward Voltage	V_{SD}	$I_S=10A, V_{GS}=0V$	-	-	1.4	V
Reverse Recovery Time	t_{rr}	$I_S=10A, V_{GS}=0V,$ $dI_S/dt=100A/\mu s$	-	176	-	ns
Reverse Recovery Charge	Q_{rr}		-	0.7	-	μC

Note 1) Repetivity rating : Pulse width limited by junction temperature.

Note 2) $L=5.5mH, I_S=10A, V_{DD}=50V, R_G=25\Omega$, Starting $T_j=25\text{ °C}$.

Note 3) $I_S \leq 10A, dI/dt \leq 200A/\mu s, V_{DD} \leq BV_{DSS}$, Starting $T_j=25\text{ °C}$.

Note 4) Pulse Test : Pulse width $\leq 300\mu s$, Duty Cycle $\leq 2\%$.

Note 5) Essentially independent of operating temperature.

Marking

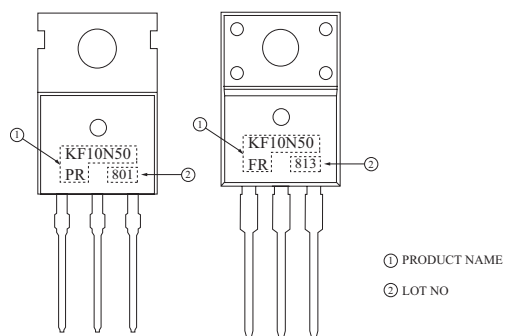

KF10N50PR/FR

Fig1. $I_D - V_{DS}$

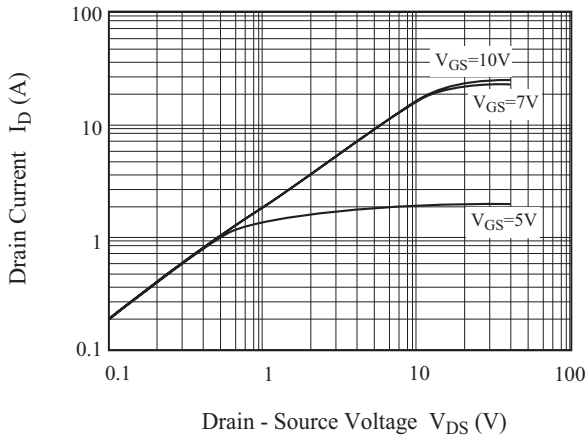

Fig2. $I_D - V_{GS}$

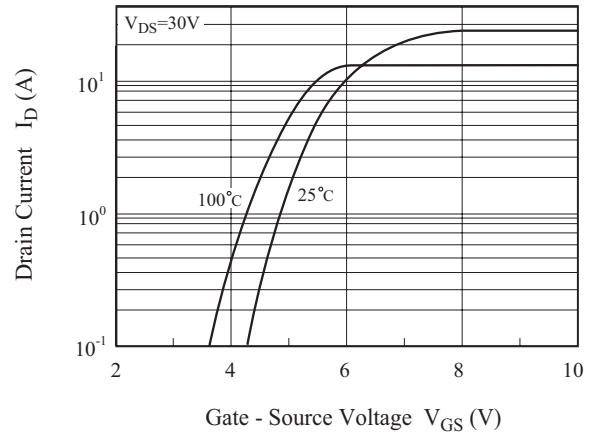

Fig3. $BV_{DSS} - T_j$

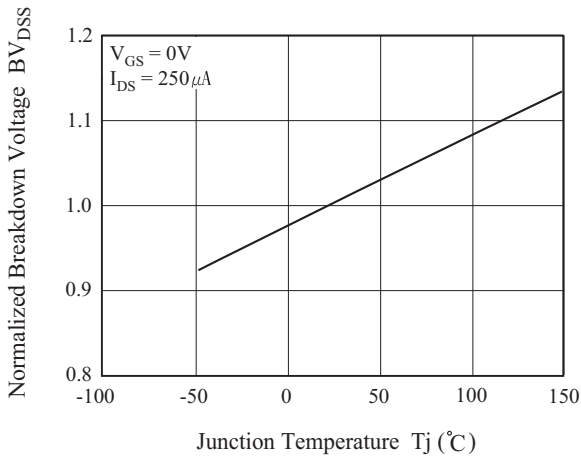

Fig4. $R_{DS(ON)} - I_D$

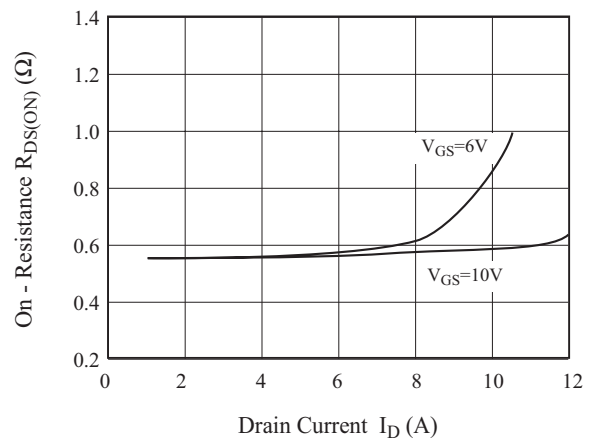

Fig5. $I_S - V_{SD}$

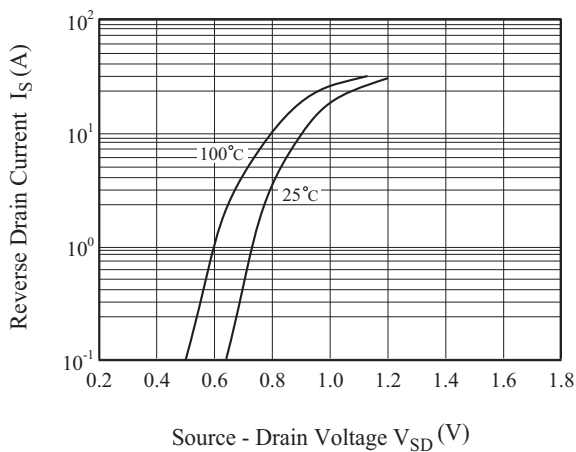
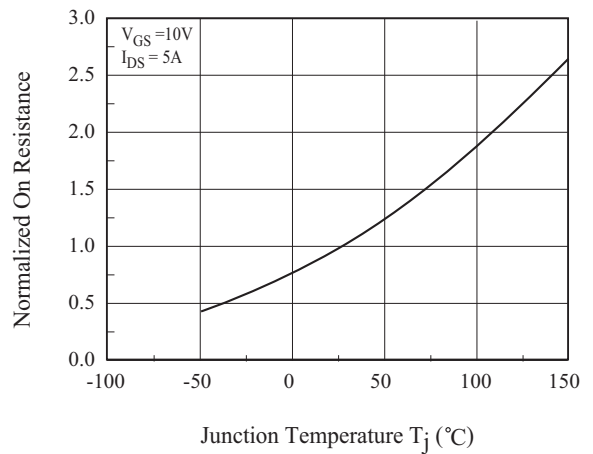

Fig6. $R_{DS(ON)} - T_j$



KF10N50PR/FR

Fig 7. C - V_{DS}

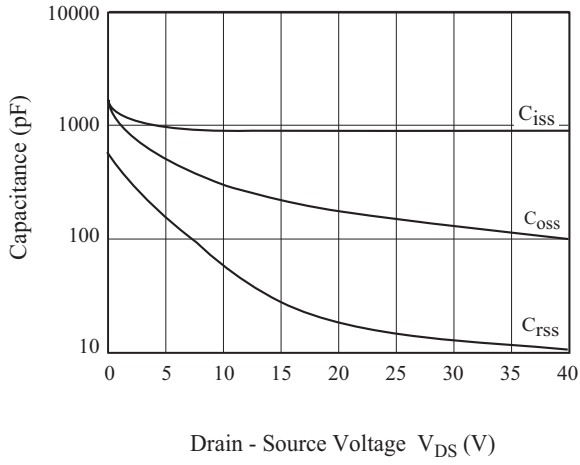

Fig8. Q_g - V_{GS}

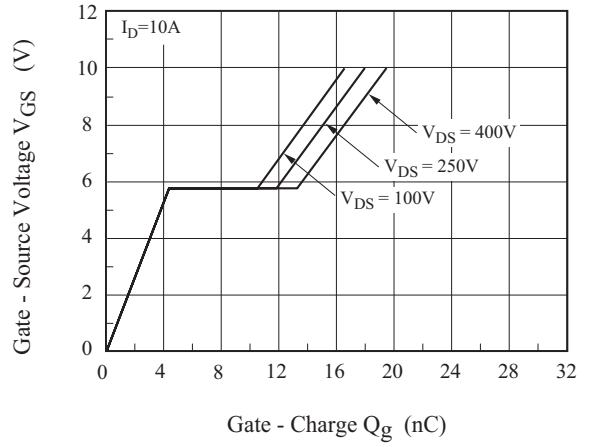

Fig9. Safe Operation Area

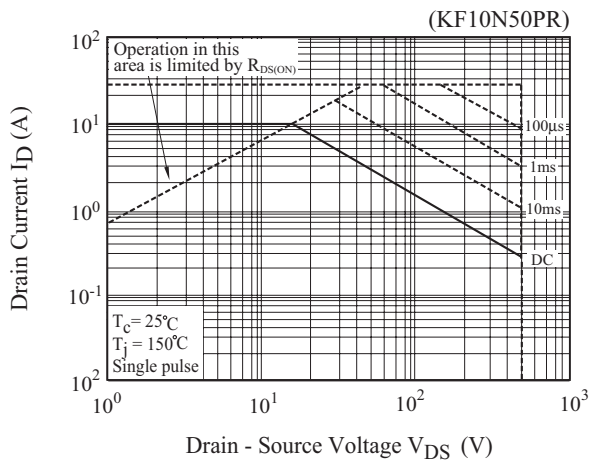

Fig10. Safe Operation Area

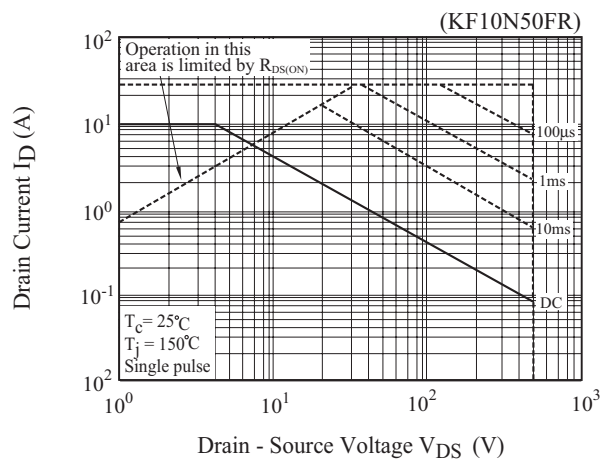
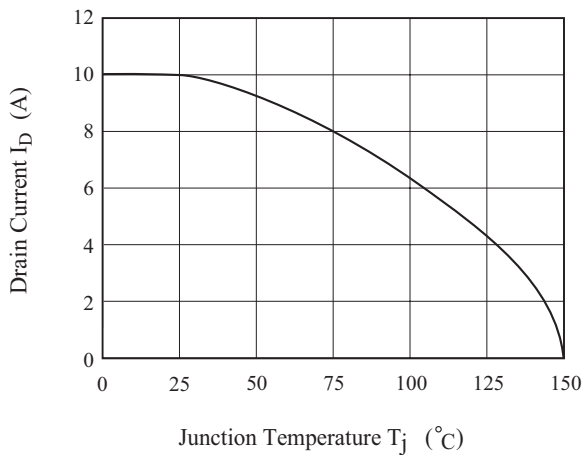

Fig11. I_D - T_j



KF10N50PR/FR

Fig12. Transient Thermal Response Curve

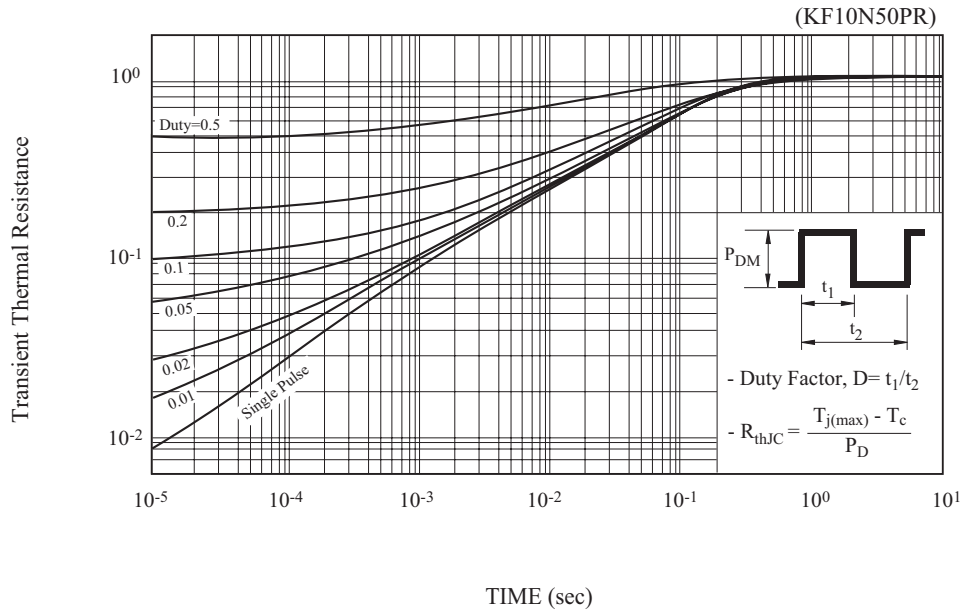
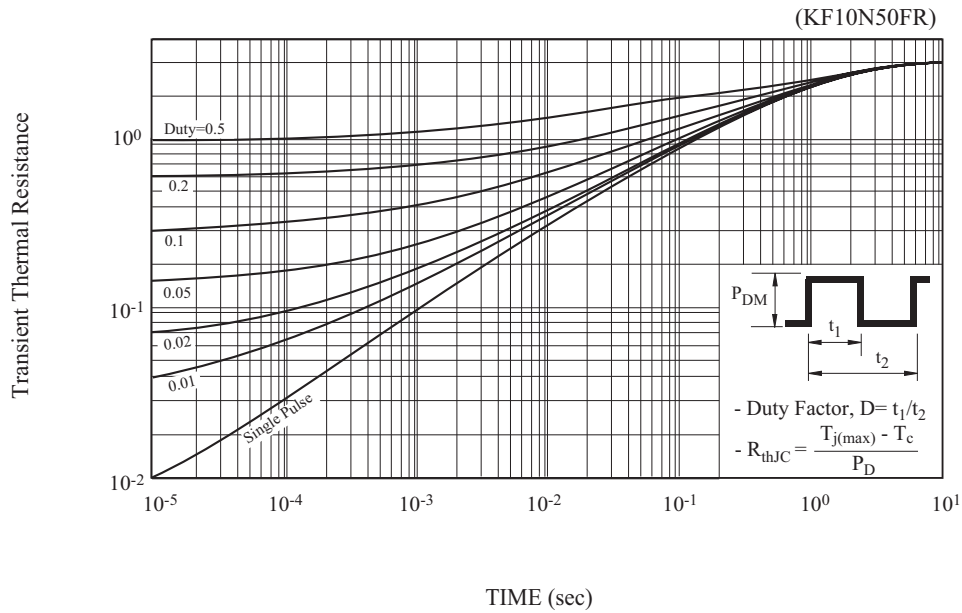

Fig13. Transient Thermal Response Curve



KF10N50PR/FR

Fig14. Gate Charge

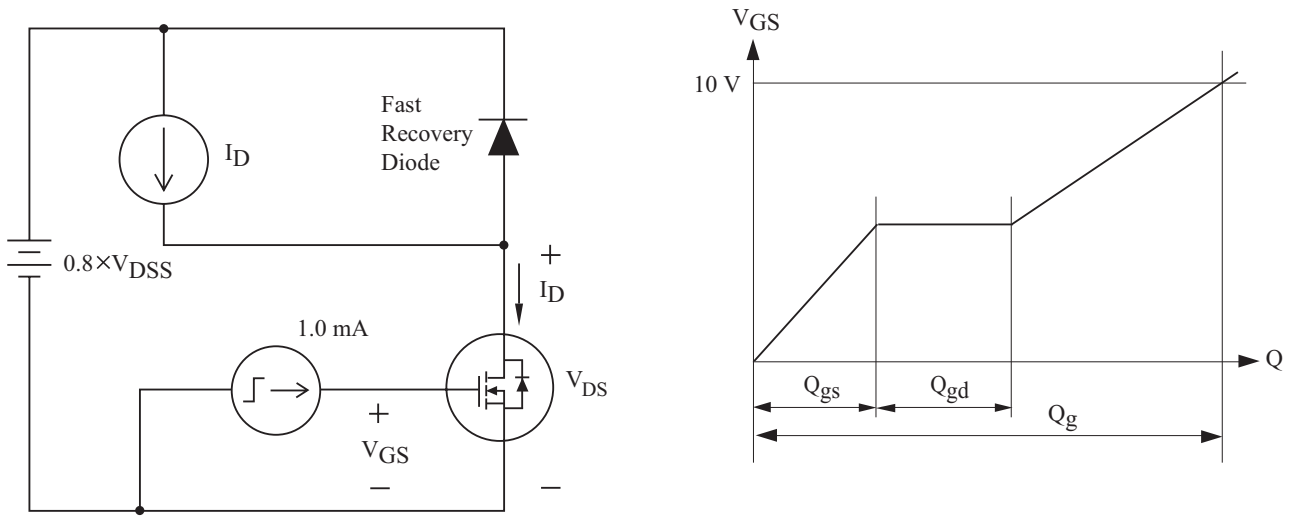

Fig15. Single Pulsed Avalanche Energy

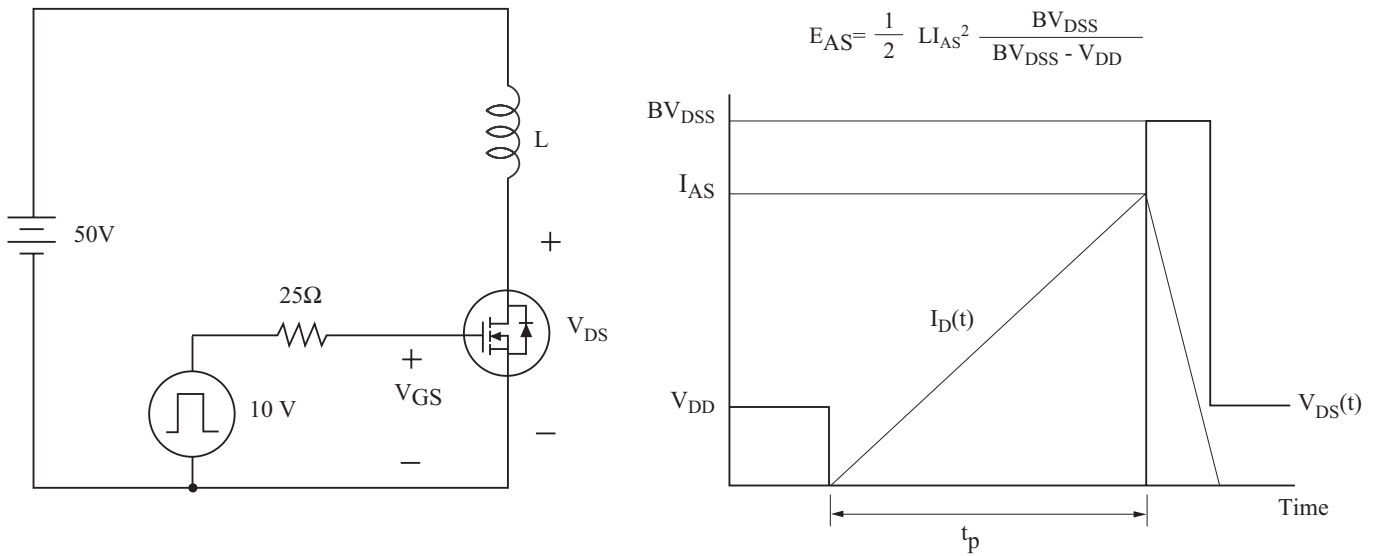
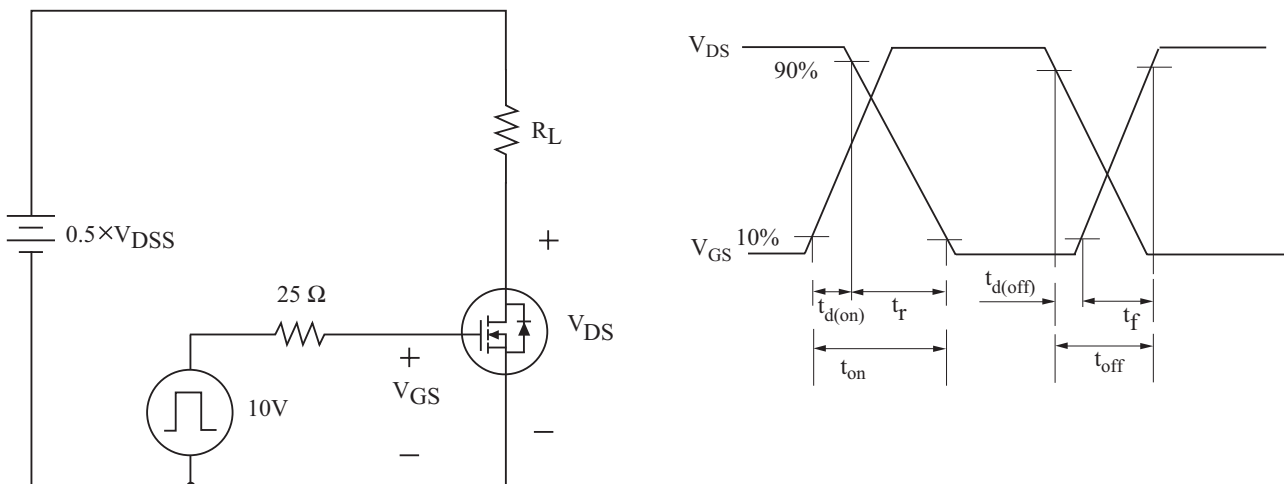

Fig16. Resistive Load Switching



KF10N50PR/FR

Fig17. Source - Drain Diode Reverse Recovery and dv/dt

