

LCD Module Specification

Model: LG128642-BMDWH6V

Table of Contents

● COVER & CONTENTS	1
● BASIC SPECIFICATIONS	2
● ABSOLUTE MAXIMUM RATINGS	3
● ELECTRICAL CHARACTERISTICS	4
● OPERATING PRINCIPLES & METHODES	7
● DISPLAY CONTROL INSTRUCTIONS	10
● DISPLAY DATA RAM ADDRESS MAP	13
● CONNECTION WITH 8051 FAMILY MPU	14
● ELECTRO—OPTICAL CHARACTERISTICS	15
● DIMENSIONAL OUTLINE	17
● LCD MODULE NUMBERING SYSTEM	18
● PRECAUTIONS FOR USE OF LCD MODULE	19

1.3 Terminal Functions

Pin No.	Symbol	Level	Function
1	VDD	+5V	Power supply for logic
2	VSS	0V	Ground
3	VO	-	Operating voltage for LCD (contrast adjusting)
4	DB0	H/L	Data bit0
5	DB1	H/L	Data bit1
6	DB2	H/L	Data bit2
7	DB3	H/L	Data bit3
8	DB4	H/L	Data bit4
9	DB5	H/L	Data bit5
10	DB6	H/L	Data bit6
11	DB7	H/L	Data bit7
12	/CS1	L	Chip selection for IC1, active "L"
13	/CS2	L	Chip selection for IC2, active "L"
14	/RST	L	Reset signal, active "L"
15	R/W	H/L	Read/Write selection H: Read operation L: Write operation
16	RS	H/L	Register selection H: Display data L: Instruction code
17	E	H, H→L	Enable signal. Read data when E is "H", write data at the falling edge of E
18	VOUT	-10V	Output voltage for LCD driving
19	LEDA	+5V	Power supply for LED backlight
20	LEDK	0V	Power supply for LED backlight

2. ABSOLUTE MAXIMUM RATINGS

Item	Symbol	Min.	Max.	Unit
Supply Voltage(Logic)	VDD-VSS	-0.3	7.0	V
Supply Voltage(LCD)	VDD-VO	-0.3	19.0	V
Input Voltage	VI	-0.3	VDD+0.3	V
Operating Temp.	Topr	-20	70	°C
Storage Temp.	Tstg	-30	80	°C

3. ELECTRICAL CHARACTERISTICS

3.1 DC Characteristics

(VDD=5.0V±10%, Ta=25°C)

Item	Symbol	Condition	Min.	Typ.	Max.	Unit
Supply Voltage (Logic)	VDD		4.5	5.0	5.5	V
Supply Voltage (LCD Driving)	VDD-VO		--	11.2	--	V
Input High Voltage	VIH		2.0	--	VDD	V
Input Low Voltage	VIL		0	--	0.8	V
Output High Voltage	VOH	IOH=-0.2mA	2.4	--	VDD	V
Output Low Voltage	VOL	IOL=1.6mA	0	--	0.4	V
Supply Current (Logic)	IDD	VDD=5.0V	--	6.0	8.0	mA

3.2 Interface Timing Chart

(VDD=5.0V±10%, Ta=25°C)

Characteristic	Symbol	Min.	Typ.	Max.	Unit
E Cycle	tc	1000	--	--	ns
E High Level Width	tWH	450	--	--	ns
E Low Level Width	tWL	450	--	--	ns
E Rise Time	tR	--	--	25	ns
E Fall Time	tF	--	--	25	ns
Address Set-Up Time	tASU	140	--	--	ns
Address Hold Time	tAH	10	--	--	ns
Data Set-Up Time	tDSU	200	--	--	ns
Data Delay Time	tD	--	--	320	ns
Data Hold Time(Write)	tDHW	10	--	--	ns
Data Hold Time(Read)	tDHR	10	--	--	ns



Fig.1 MPU Write Timing

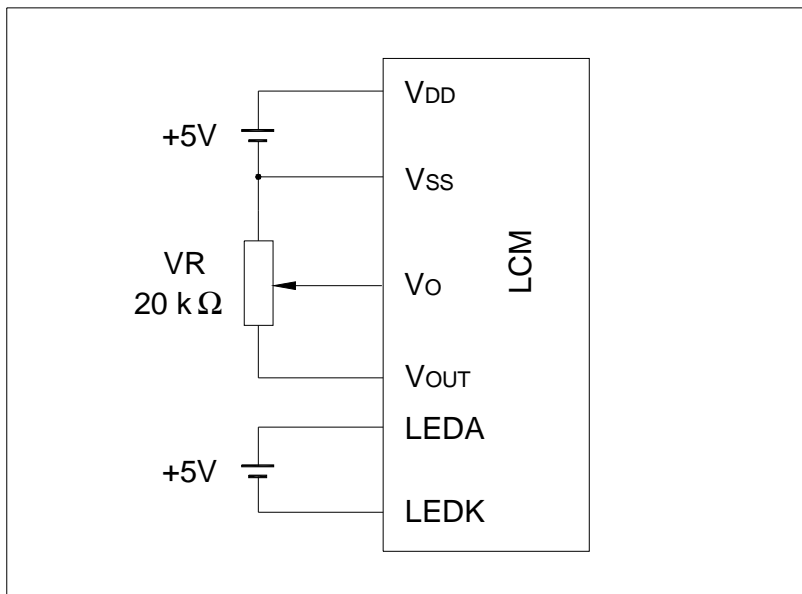

Fig.2 MPU Read Timing

3.3 LED Backlight Characteristics (Ta=25°C)

Item	Symbol	Condition	Min.	Typ.	Max.	Unit
Forward Voltage	Vf		2.9	3.1	3.3	V
Forward Current	If	Vf=3.1V	--	45	--	mA
Color	White					

3.4 Power Supply



Note: 5V voltage for the LED backlight should be supplied to Pin19 (LEDA) and Pin20 (LEDK) terminal of the interface, it should not be supplied to the Anode/Cathode terminal of the LED backlight directly.

4. OPERATING PRINCIPLES & METHODES

4.1 I/O Buffer

Input buffer controls the status between the enable and display of chip. Unless the IC (selected by /CS1, /CS2) is in active mode, input or output of data and instruction does not execute. Therefore internal state is maintained. But /RST can operate regardless the level of /CS1 or /CS2.

4.2 Register

Both input register and output register are provided to interface to MPU of which the speed is different from that of internal operation. The selections of these registers depend on the combination of R/W and RS signals.

RS	R/W	Function
L	L	Instruction
	H	Status read (busy check)
H	L	Data write (from input register to display data RAM)
	H	Data read (from display data RAM to output register)

4.2.1 Input Register

Input register stores the data temporarily before writing it into display data RAM.

When the IC is in active mode, R/W and RS select the input register. The data from MPU is written into input register, then into display data RAM. Data is latched at falling edge of the E signal and then written into the display data RAM automatically by internal operation.

4.2.2 Output Register

Output register stores the data temporarily which is read from display data RAM when the IC is in active mode and R/W and RS=H, stored data in display data RAM is latched in output register. When the IC is in active mode and R/W=H, RS=L, status data (busy check) can be read out.

To read the contents of display data RAM, twice access of read instruction is needed. In first access, data in display data RAM is latched into output register. In second access, MPU can read data that is latched in output register. That is, to read the data in display data RAM, it needs dummy read. But status read does not need dummy read.

The following shows the MPU read timing.

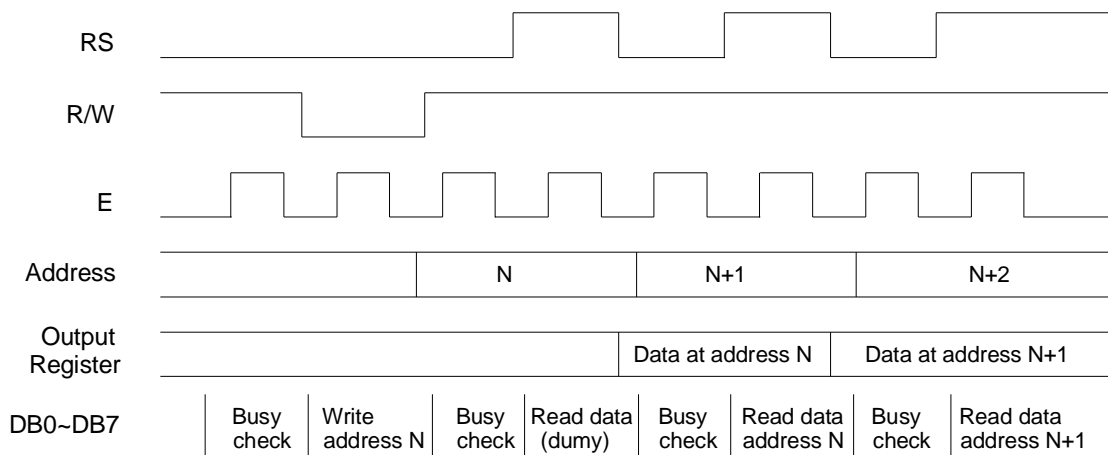

MPU Read Timing

4.3 Reset

The system can be initialized by setting /RST terminal at low level when turning power on. When /RST becomes low, following procedure is occurred.

1. Display off
2. Display start line register is set by 0. (Z-address 0)

While /RST is low level, no instruction except status read can be accepted. Reset status appears at DB4 of status byte, after DB4 becomes “L”, any instruction can be accepted. The conditions of power supply at initial power up are shown below.

Item	Symbol	Min.	Typ.	Max.	Unit
Reset time	t_{RS}	1.0	--	--	μ s
Rise time	t_R	--	--	200	ns

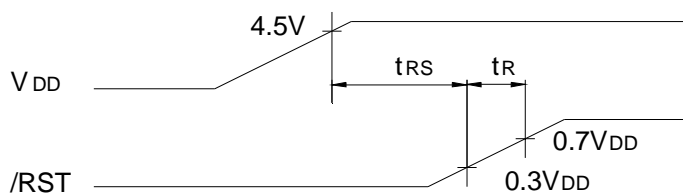

4.4 Busy Flag

Busy flag indicates the system is now internally operating or not. When busy flag is “H”, the system is in internal operation. When busy flag is “L”, the system can accept data or instruction. Busy flag is read out on DB7 by the Status Read instruction.

4.5 Display On/Off Flip-Flop

The display on/off flip-flop makes on/off the liquid crystal display. When flip-flop is reset (logical low), selective voltage or non selective voltage appears on segment output terminals. When flip-flop is set (logical high), non selective voltage appears on segment output terminals regardless of display RAM data.

The display on/off flip-flop can change status by instruction. The display data at all segments disappear while /RST is low. The status of the flip-flop is output on DB5 by Status Read instruction.

4.6 X Page Register

X page register designates page of the internal display data RAM. Count function is not available. An address is set by instruction.

4.7 Y Address Counter

Y address counter designates address of the internal display data RAM. An address is set by instruction and is increased by 1 automatically by read or write operations of display data.

4.8 Display Data RAM

Display data RAM stores a display data for liquid crystal display. 1 bit data of this RAM corresponds to light ON (data=1) or light OFF (data=0) of 1 dot on the display panel.

4.9 Display Start Line Register

The register specifies a line in display data RAM that corresponds to the top line of LCD panel, when displaying contents in display data RAM on the LCD panel. Bit data (DB<0:5>) of the display start line information is written into this register by display start line set instruction. It is used for scrolling of the liquid crystal display screen.

5. DISPLAY CONTROL INSTRUCTIONS

The display control instructions control the internal state of the KS0108B. Instruction is received from MPU to KS0108B for the display control. The following table shows various instructions.

Instruction	RS	R/W	DB7	DB6	DB5	DB4	DB3	DB2	DB1	DB0	Function	
Display ON/OFF	0	0	0	0	1	1	1	1	1	0/1	Controls the display on or off. Internal status and display RAM data are not affected.	
Set Address (Y address)	0	0	0	1	Y address (0-63)						Sets the Y address at the Y address counter.	
Set Page (X address)	0	0	1	0	1	1	1	Page (0-7)			Sets the X address at the X address register.	
Display Start Line (Z address)	0	0	1	1	Display start line (0-63)						Indicates the display data RAM displayed at the top of the screen.	
Status Read	0	1	B U S Y	0	O N / O F F	R E S E T	0	0	0	0	Reads status. BUSY 0: Ready 1: In internal operation ON/OFF 0: Display ON 1: Display OFF RESET 0: Normal 1: Reset	
Write Display Data	1	0	Display Data									Writes data (DB0~DB7) into display data RAM. After writing instruction, Y address is increased by 1 automatically.
Read Display Data	1	1	Display Data									Reads data (DB0~DB7) from display data RAM to the data bus.

5.1 Display On/Off

RS	R/W	DB7	DB6	DB5	DB4	DB3	DB2	DB1	DB0
0	0	0	0	1	1	1	1	1	D

The display data appears when D is 1 and disappears when D is 0.

Though the data is not on the screen with D=0, it remains in the display data RAM.

Therefore, you can make it appear by changing D=0 into D=1.

5.2 Set Address (Y Address)

RS	R/W	DB7	DB6	DB5	DB4	DB3	DB2	DB1	DB0
0	0	0	1	AC5	AC4	AC3	AC2	AC1	AC0

Y address (AC0~AC5) of the display data RAM is set in the Y address counter.

An address is set by instruction and increased by 1 automatically by read or write operations of display data.

5.3 Set Page (X Address)

RS	R/W	DB7	DB6	DB5	DB4	DB3	DB2	DB1	DB0
0	0	1	0	1	1	1	AC2	AC1	AC0

X address (AC0-AC2) of the display data RAM is set in the X address register.

Writing or reading to or from MPU is executed in this specified page until the next page is set.

5.4 Display Start Line (Z Address)

RS	R/W	DB7	DB6	DB5	DB4	DB3	DB2	DB1	DB0
0	0	1	1	AC5	AC4	AC3	AC2	AC1	AC0

Z address (AC0~AC5) of the display data RAM is set in the display start line register and displayed at the top of the screen.

5.5 Status Read

RS	R/W	DB7	DB6	DB5	DB4	DB3	DB2	DB1	DB0
0	1	BUSY	0	ON/OFF	RESET	0	0	0	0

- **BUSY**

When BUSY is 1, the chip is executing internal operation and no instructions are accepted.

When BUSY is 0, the chip is ready to accept any instructions.

- **ON/OFF**

When ON/OFF is 1, the display is off.

When ON/OFF is 0, the display is on.

- **RESET**

When RESET is 1, the system is being initialized.

In this condition, no instructions except status read can be accepted.

When RESET is 0, initializing has finished and the system is in the normal operation condition.

5.6 Write Display Data

RS	R/W	DB7	DB6	DB5	DB4	DB3	DB2	DB1	DB0
1	0	D7	D6	D5	D4	D3	D2	D1	D0

Write data (D0~D7) into the display data RAM.

After writing instruction, Y address is increased by 1 automatically.

5.7 Read Display Data

RS	R/W	DB7	DB6	DB5	DB4	DB3	DB2	DB1	DB0
1	1	D7	D6	D5	D4	D3	D2	D1	D0

Read data (D0~D7) from the display data RAM.

After reading instruction, Y address is increased by 1 automatically.

One time of dummy read must be required after column address setting.

6. DISPLAY DATA RAM ADDRESS MAP

Page Address	Display Data	1st KS0108B						2nd KS0108B						Line Address	Common
B8	D0													C0	COM1
	D1													C1	COM2
	D2													C2	COM3
	D3													C3	COM4
	D4													C4	COM5
	D5													C5	COM6
	D6													C6	COM7
	D7													C7	COM8
B9	D0													C8	COM9
	D1													C9	COM10
	D2													CA	COM11
	D3													CB	COM12
	D4													CC	COM13
	D5													CD	COM14
	D6													CE	COM15
	D7													CF	COM16
BA	D0													D0	COM17
	D1													D1	COM18
	D2													D2	COM19
	D3													D3	COM20
	D4													D4	COM21
	D5													D5	COM22
	D6													D6	COM23
	D7													D7	COM24
BB	D0													D8	COM25
	D1													D9	COM26
	D2													DA	COM27
	D3													DB	COM28
	D4													DC	COM29
	D5													DD	COM30
	D6													DE	COM31
	D7													DF	COM32
BC	D0													E0	COM33
	D1													E1	COM34
	D2													E2	COM35
	D3													E3	COM36
	D4													E4	COM37
	D5													E5	COM38
	D6													E6	COM39
	D7													E7	COM40
BD	D0													E8	COM41
	D1													E9	COM42
	D2													EA	COM43
	D3													EB	COM44
	D4													EC	COM45
	D5													ED	COM46
	D6													EE	COM47
	D7													EF	COM48
BE	D0													F0	COM49
	D1													F1	COM50
	D2													F2	COM51
	D3													F3	COM52
	D4													F4	COM53
	D5													F5	COM54
	D6													F6	COM55
	D7													F7	COM56
BF	D0													F8	COM57
	D1													F9	COM58
	D2													FA	COM59
	D3													FB	COM60
	D4													FC	COM61
	D5													FD	COM62
	D6													FE	COM63
	D7													FF	COM64
Column Address		40	41	42	-	7D	7E	7F	40	41	42	-	7D	7E	7F
Segment		SEG1	SEG2	SEG3	-	SEG62	SEG63	SEG64	SEG65	SEG66	SEG67	-	SEG126	SEG127	SEG128

7. CONNECTION WITH 8051 FAMILY MPU



a. Application Circuit 1



b. Application Circuit 2

8. ELECTRO—OPTICAL CHARACTERISTICS ($T_a=25^{\circ}C$)

Item	Symbol	Condition	Min.	Typ.	Max.	Unit	Note
View Angle	$\Phi 2-\Phi 1$	$K \geq 2, \theta = 0^{\circ}$	--	70	--	Deg	Note1, Note2
Contrast	K	$\Phi = 0^{\circ}, \theta = 0^{\circ}$	3	--	--	--	Note3
Response Time	tr (rise)	$\Phi = 0^{\circ}, \theta = 0^{\circ}$	--	250	--	ms	Note3
	tf (fall)	$\Phi = 0^{\circ}, \theta = 0^{\circ}$	--	250	--	ms	

Note1: Definition of Viewing Angle θ, Φ



Note2: Definition of viewing Angle Range: $\Phi 1, \Phi 2$

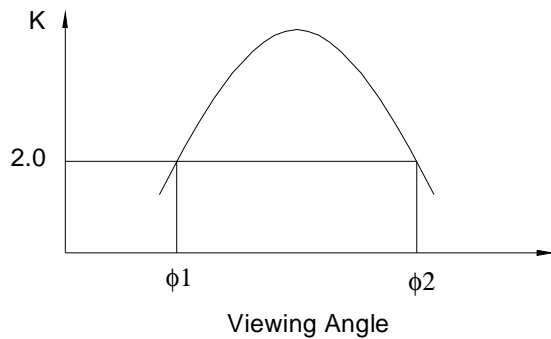

Note3: Definition of Contrast

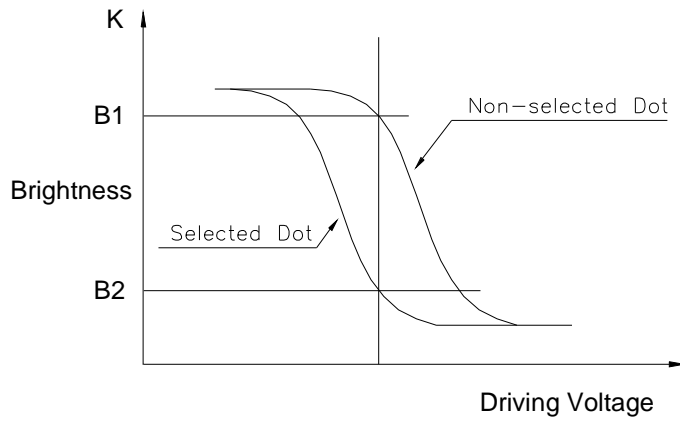

$$\text{Contrast} = \frac{\text{Brightness of non-selected dot (B1)}}{\text{Brightness of selected dot (B2)}}$$

Note4: Definition of Response Time

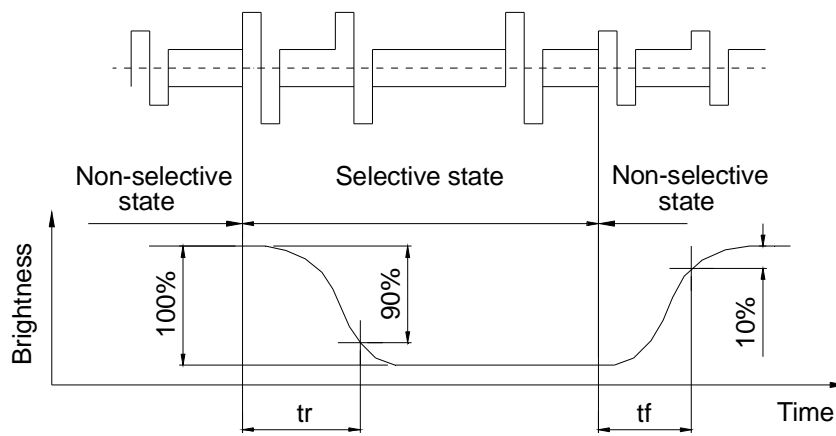

9. DIMENSIONAL OUTLINE

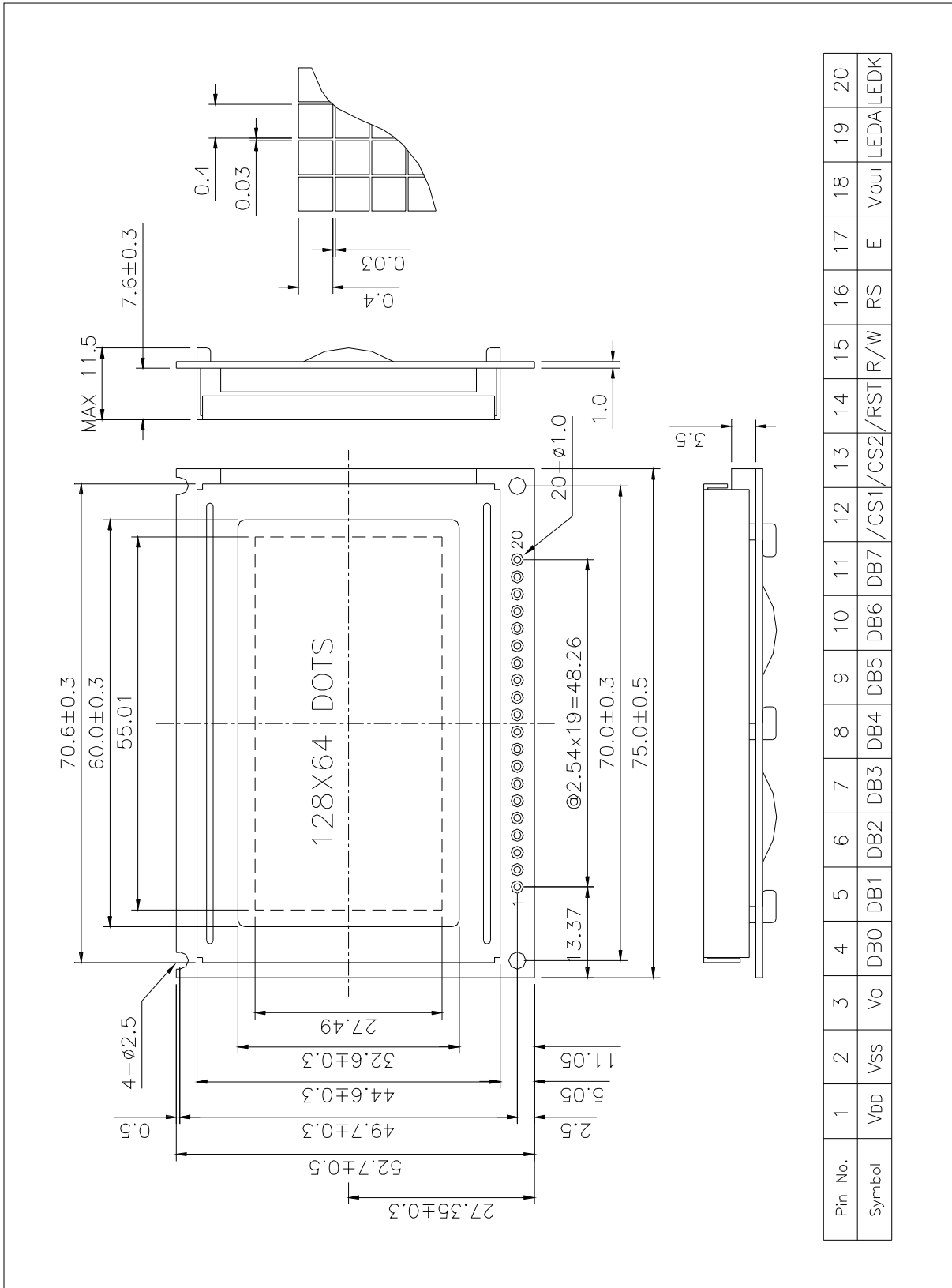

10. LCD MODULE NUMBERING SYSTEM

L G 128 64 2 — B M D W H 6 V — XXX
 (1) (2) (3) (4) (5) (6) (7) (8) (9) (10) (11) (12) (13)

(1) Brand

(2) Module type

C - Character module

G - Graphic module

(3) Display format

Character module : Number of characters per line, two digits XX

Graphic module : Number of columns, two or three digits XX or XXX

(4) Display format

Character module : Number of lines, one digit X

Graphic module : Number of rows, two or three digits XX or XXX

(5) Development number : One digit X (**1~9, A~Z**)

(6) LCD mode

T - TN Positive, Gray

N - TN Negative, Blue

S - STN Positive, Yellow-green

G - STN Positive, Gray

B - STN Negative, Blue

F - FSTN Positive, White

K - FSTN Negative, Black

L - FSTN Negative, Blue

(7) Polarizer mode

R - Reflective

F - Transflective

M - Transmissive

(8) Backlight type

N - Without backlight

L - Array LED

D - Edge light LED

E - EL

C - CCFL

(9) Backlight color

Y - Yellow-green

B - Blue

W - White

G - Green

A - Amber

R - Red

M - Multi color

Nil - Without backlight

(10) Operating temperature range

S - Standard temperature (0 ~ +50 °C)

H - Extended Temperature (-20 ~ +70 °C)

(11) Viewing direction

3 - 3:00

6 - 6:00

9 - 9:00

U - 12:00

(12) DC-DC Converter

N or Nil - Without DC-DC converter

V - Built in DC-DC converter

(13) Version code

0~ZZZ - Version code

11. PRECAUTIONS FOR USE OF LCD MODULE

11.1 Handling Precautions

- 1) The display panel is made of glass. Do not subject it to a mechanical shock by dropping it from a high place, etc.
- 2) If the display panel is damaged and the liquid crystal substance inside it leaks out, be sure not to get any in your mouth. If the substance comes into contact with your skin or clothes, promptly wash it off using soap and water.
- 3) Do not apply excessive force on the surface of display or the adjoining areas of LCD module since this may cause the color tone to vary.
- 4) The polarizer covering the display surface of the LCD module is soft and easily scratched. Handle this polarizer carefully.
- 5) If the display surface of LCD module becomes contaminated, blow on the surface and gently wipe it with a soft dry cloth. If it is heavily contaminated, moisten cloth with one of the following solvents.

- Isopropyl alcohol
- Ethyl alcohol

Solvents other than those mentioned above may damage the polarizer.

Especially, do not use the following:

- Water
 - Ketone
 - Aromatic Solvents
- 6) When mounting the LCD module make sure that it is free of twisting, warping, and distortion. Distortion has great influence upon display quality. Also keep the stiffness enough regarding the outer case.
 - 7) Be sure to avoid any solvent such as flux for soldering never stick to Heat-Seal. Such solvent on Heat-Seal may cause connection problem of heat-Seal and TAB.
 - 8) Do not forcibly pull or bend the TAB I/O terminals.
 - 9) Do not attempt to disassemble or process the LCD module.
 - 10) NC terminal should be open. Do not connect anything.
 - 11) If the logic circuit power is off, do not apply the input signals.
 - 12) To prevent destruction of the elements by static electricity, be careful to maintain an optimum work environment.
 - Be sure to ground the body when handling the LCD module.
 - Tools required for assembly, such as soldering irons, must be properly grounded.
 - To reduce the amount of static electricity generated, do not conduct assembly and other work under dry conditions.
 - The LCD module is coated with a film to protect the display surface. Exercise care when peeling off this protective film since static electricity may be generated.

11.2 Storage Precautions

- 1) When storing the LCD module, avoid exposure to direct sunlight or to the light of fluorescent lamps and high temperature/high humidity. Whenever possible, the LCD module should be stored in the same conditions in which they were shipped from our company.
- 2) Exercise care to minimize corrosion of the electrodes. Corrosion of the electrodes is accelerated by water droplets or a current flow in a high humidity environment.

11.3 Design Precautions

- 1) The absolute maximum ratings represent the rated value beyond which LCD module can not exceed. When the LCD modules are used in excess of this rated value, their operating characteristics may be adversely affected.
- 2) To prevent the occurrence of erroneous operation caused by noise, attention must be paid to satisfy VIL, VIH specification values, including taking the precaution of using signal cables that are short.
- 3) The liquid crystal display exhibits temperature dependency characteristics. Since recognition of the display becomes difficult when the LCD is used outside its designated operating temperature range, be sure to use the LCD within this range. Also, keep in mind that the LCD driving voltage levels necessary for clear displays will vary according to temperature.
- 4) Sufficiently notice the mutual noise interference occurred by peripheral devices.
- 5) To cope with EMI, take measures basically on outputting side.
- 6) If DC is impressed on the liquid crystal display panel, display definition is rapidly deteriorated by the electrochemical reaction that occurs inside the liquid crystal display panel. To eliminate the opportunity of DC impressing, be sure to maintain the AC characteristics of the input signals sent to the LCD Module.

11.4 Others

- 1) Liquid crystals solidify under low temperatures (below the storage temperature range) leading to defective orientation or the generation of air bubbles (black or white).
Air bubbles may also be generated if the LCD module is subjected to a strong shock at a low temperature.
- 2) If the LCD modules have been operating for a long time showing the same display patterns, the display patterns may remain on the screen as ghost images and a slight contrast irregularity may also appear. A normal operating status can be regained by suspending use for some time. It should be noted that this phenomenon does not adversely affect performance reliability.
- 3) To minimize the performance degradation of the LCD modules resulting from destruction caused by static electricity, etc., exercise care to avoid touching the following sections when handling the module:
 - Terminal electrode sections.
 - Part of pattern wiring on TAB, etc.