

LF100EDI Series

Low Cost, Dual Output High Isolation 1W SMT DC/DC Converters

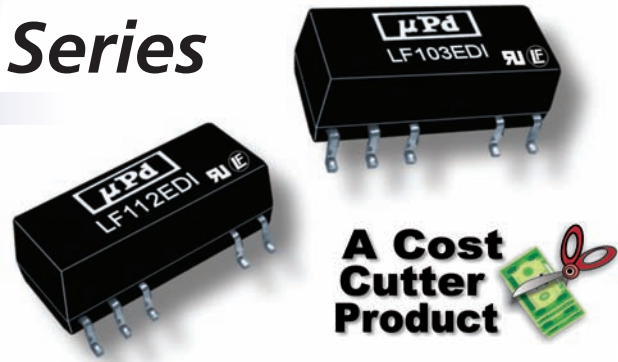

Key Features:

- 1W Output Power
- 3,000 VDC Isolation
- Ultra-Miniature SMT Case
- UL Approved (File E245422)
- Dual Outputs
- Low 0.24" Profile
- >3.5 MHour MTBF
- 3.3, 5V, & 12V Inputs
- **LOWEST COST!**

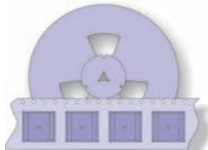

**Tape/Reel
Available**

MicroPower Direct

292 Page Street
Suite D
Stoughton, MA 02072
USA

T: (781) 344-8226
F: (781) 344-8481
E: sales@micropowerelectronics.com
W: www.micropowerelectronics.com



Electrical Specifications

Specifications typical @ +25°C, nominal input voltage & rated output current, unless otherwise noted. Specifications subject to change without notice.

Input

Parameter	Conditions	Min.	Typ.	Max.	Units
Input Voltage Range	3.3 VDC Input	3.0	3.3	3.6	VDC
	5 VDC Input	4.5	5.0	5.5	
	12 VDC Input	10.8	12.0	13.2	
Reverse Polarity Input Current				1.0	A
Input Filter	Capacitor				

Output

Parameter	Conditions	Min.	Typ.	Max.	Units
Output Voltage Accuracy			±3.0		%
Output Voltage Balance	Balanced Loads		±1.0		%
Line Regulation	For Vin Change of 1%			±1.2	%
Load Regulation (Note 1)	See Model Selection Guide				
Ripple & Noise (20 MHz) (Note 2)			50	75	mV P - P
Temperature Coefficient			±0.01	±0.02	%/°C
Output Short Circuit	Momentary (0.5 Sec.)				

General

Parameter	Conditions	Min.	Typ.	Max.	Units
Isolation Voltage	60 Seconds	3,000			VDC
Isolation Resistance	500 VDC	1,000			MΩ
Isolation Capacitance	100 kHz, 1V		70		pF
Switching Frequency		100	150	200	kHz

Environmental

Parameter	Conditions	Min.	Typ.	Max.	Units
Operating Temperature Range	Ambient	-40	+25	+85	°C
Storage Temperature Range		-55		+125	°C
Cooling	Free Air Convection				
Humidity	RH, Non-condensing			95	%

Physical

Case Size	0.60 x 0.29 x 0.24 Inches (15.24 x 7.5 x 6.0 mm)				
Case Material	Non-Conductive Black Plastic (UL94-V0)				
Weight	0.05 Oz (1.5g)				

Reliability Specifications

Parameter	Conditions	Min.	Typ.	Max.	Units
MTBF	MIL HDBK 217F, 25°C, Gnd Benign	3.5			MHours
Safety Standards	UL 1950, EN 60950, IEC 60950				
Safety Approvals	UL, cUL; File No. E245422				

Absolute Maximum Ratings

Parameter	Conditions	Min.	Typ.	Max.	Units
Input Voltage Surge (1 Sec)	3.3 VDC Input	-0.7		7.0	VDC
	5 VDC Input	-0.7		7.0	
	12 VDC Input	-0.7		15.0	
Lead Temperature	1.5 mm From Case For 10 Sec			260.0	°C
Internal Power Dissipation	All Models			450	mW

Caution: Exceeding Absolute Maximum Ratings may damage the module. These are not continuous operating ratings.

Model Selection Guide

Model Number	Input				Output			Load Regulation (% Max)	Efficiency (% Typ)	Fuse Rating Slow-Blow (mA)
	Voltage (VDC)		Current (mA)		Voltage (VDC)	Current (mA, Max)	Current (mA, Min)			
	Nominal	Range	Full-Load	No-Load						
LF101EDI	5	4.5 - 5.5	294	30	±5.0	±100.0	±10.0	12.0	68	500
LF102EDI	5	4.5 - 5.5	277	30	±9.0	±56.0	±6.0	8.0	72	500
LF103EDI	5	4.5 - 5.5	270	30	±12.0	±42.0	±5.0	8.5	74	500
LF104EDI	5	4.5 - 5.5	270	30	±15.0	±33.0	±4.0	7.0	74	500
LF111EDI	12	10.8 - 13.2	121	15	±5.0	±100.0	±10.0	12.0	69	200
LF112EDI	12	10.8 - 13.2	116	15	±9.0	±56.0	±6.0	8.0	72	200
LF113EDI	12	10.8 - 13.2	113	15	±12.0	±42.0	±5.0	8.5	74	200
LF114EDI	12	10.8 - 13.2	113	15	±15.0	±33.0	±4.0	7.0	75	200
LF151EDI	3.3	3.0 - 3.6	452	55	±5.0	±100.0	±10.0	12.0	67	750
LF152EDI	3.3	3.0 - 3.6	445	55	±12.0	±42.0	±5.0	8.5	68	750
LF153EDI	3.3	3.0 - 3.6	432	55	±15.0	±33.0	±4.0	7.0	70	750

Notes:

- Output load regulation is specified for a load change of 10% to 100%.
- When measuring output ripple, it is recommended that an external 0.33 μF ceramic capacitor be placed from the +Vout pin to the -Vout pin for single output units and from each output to common for dual output units.
- During operation, care must be taken not to exceed the specified input range of the unit or to allow the output load to drop below the specified minimum (10% of full load). Operating the unit under either of these conditions could cause damage to the unit.
- These converters are specified for operation without external components. However, in some applications the addition of input/output capacitors will enhance stability and reduce output ripple. Recommended capacitor values are:

Vin	Input Capacitor	Vout	Output Capacitor
3.3 VDC	10.0 μF	5 VDC	4.7 μF
5 VDC	4.7 μF	9 VDC	2.2 μF
12 VDC	2.2 μF	12 VDC	1.0 μF
		15 VDC	0.47 μF

Derating Curve

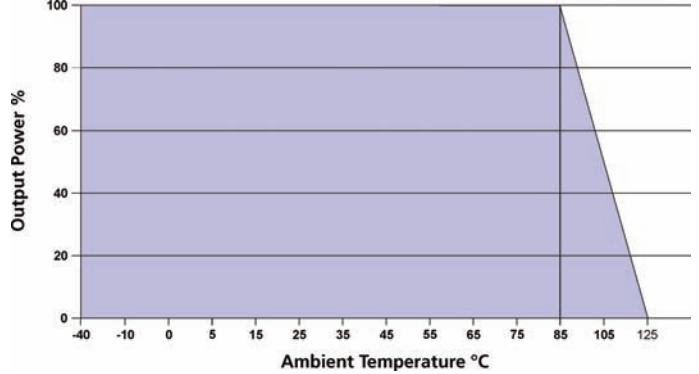

For applications requiring very low output noise levels, a simple LC filter should be effective.

- It is recommended that a fuse be used on the input of a power supply for protection. See the Model Selection table above for the correct rating.

Pin Connections

Pin	Description	Pin	Description
1	-Vin	7	NC
2	+Vin	8	+Vout
3	NC	10	NC
5	Common	11	NC
6	-Vout	12	NC

NC = No Connection

Mechanical Dimensions

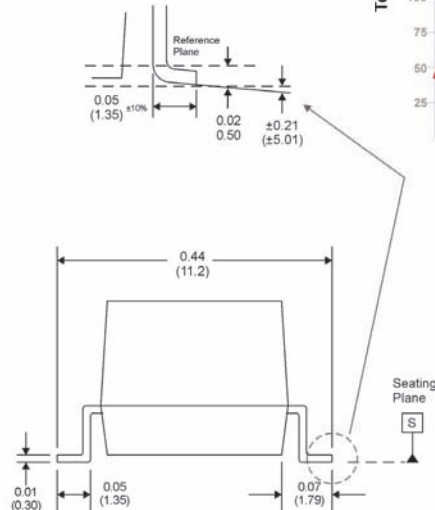
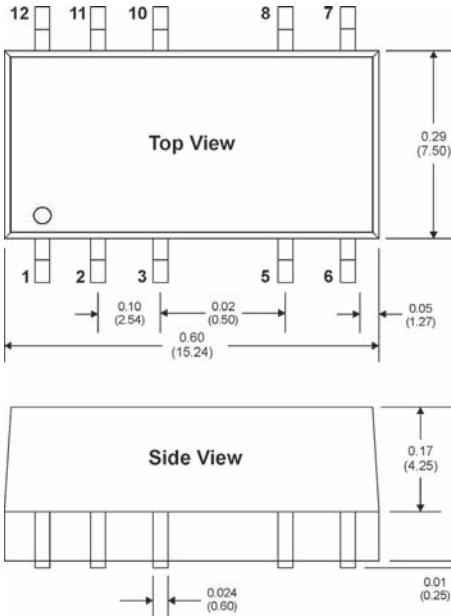

Recommended Solder Profile

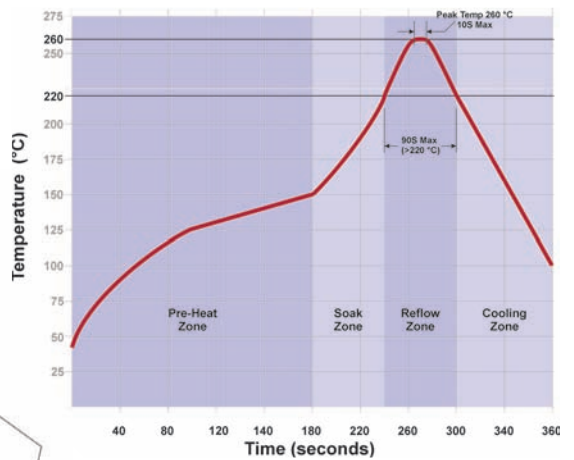

Board Layout

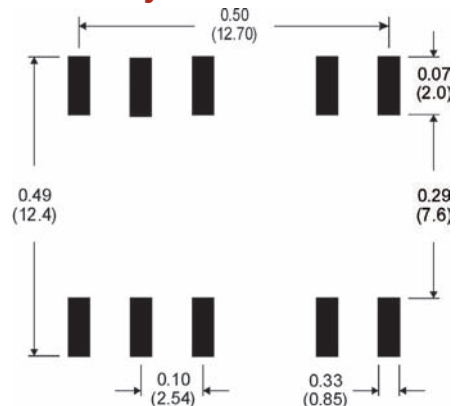

Notes:

- All dimensions are typical in inches (mm)
- Tolerance x.xx = ±0.01 (±0.25)
- Pin 1 is marked by a "dot" or indentation on the unit



MicroPower Direct
www.micropowerelectronics.com