

LF100ED Series

Lowest Cost, Dual Output Ultra-Miniature 1W SMT DC/DC Converters

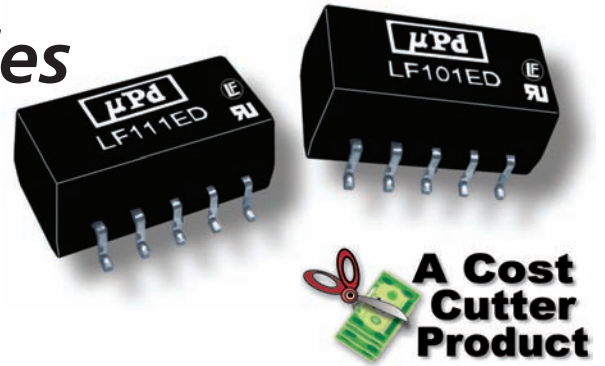

A Cost Cutter Product

Key Features:

- 1W Output Power
- Ultra-Miniature SMT Case
- UL Approved (File E245422)
- Dual Outputs
- Low 0.29" Profile
- 1,000 VDC Isolation
- >3.5 MHour MTBF
- 3.3V, 5V, & 12V Inputs
- **LOWEST COST!**

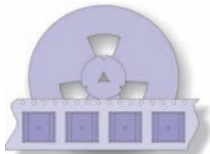

Tape/Reel Available

MicroPower Direct

292 Page Street
Suite D
Stoughton, MA 02072
USA

T: (781) 344-8226
F: (781) 344-8481
E: sales@micropowerelectronics.com
W: www.micropowerelectronics.com



Electrical Specifications

Specifications typical @ +25°C, nominal input voltage & rated output current, unless otherwise noted. Specifications subject to change without notice.

Input

Parameter	Conditions	Min.	Typ.	Max.	Units
Input Voltage Range	3.3 VDC Input	3.0	3.3	3.6	VDC
	5 VDC Input	4.5	5.0	5.5	
	12 VDC Input	10.8	12.0	13.2	
Reverse Polarity Input Current				1.0	A
Input Filter	Capacitor				

Output

Parameter	Conditions	Min.	Typ.	Max.	Units
Output Voltage Accuracy			±3.0		%
Output Voltage Balance	Balanced Loads		±1.0		%
Line Regulation	For Vin Change of 1%			±1.2	%
Load Regulation (Note 1)	See Model Selection Guide				
Ripple & Noise (20 MHz) (Note 2)			50	75	mV P - P
Temperature Coefficient				±0.03	%/°C
Output Short Circuit	Momentary (0.5 Sec.)				

General

Parameter	Conditions	Min.	Typ.	Max.	Units
Isolation Voltage	60 Seconds	1,000			VDC
Isolation Resistance	500 VDC	1,000			MΩ
Isolation Capacitance	100 kHz, 1V		70		pF
Switching Frequency			100		kHz

Environmental

Parameter	Conditions	Min.	Typ.	Max.	Units
Operating Temperature Range	Ambient	-40	+25	+85	°C
Storage Temperature Range		-55		+125	°C
Cooling	Free Air Convection				
Humidity	RH, Non-condensing			95	%

Physical

Case Size	0.60 x 0.29 x 0.24 Inches (15.24 x 7.5 x 6.0 mm)				
Case Material	Non-Conductive Black Plastic (UL94-V0)				
Weight	0.05 Oz (1.5g)				

Reliability Specifications

Parameter	Conditions	Min.	Typ.	Max.	Units
MTBF	MIL HDBK 217F, 25°C, Gnd Benign	3.5			MHours
Safety Standards	UL 1950, EN 60950, IEC 60950				
Safety Approvals	UL, cUL; File No. E245422				

Absolute Maximum Ratings

Parameter	Conditions	Min.	Typ.	Max.	Units
Input Voltage Surge (1 Sec)	3.3 VDC Input	-0.7		7.0	VDC
	5 VDC Input	-0.7		7.0	
	12 VDC Input	-0.7		15.0	
Lead Temperature	1.5 mm From Case For 10 Sec			260.0	°C
Internal Power Dissipation	All Models			450	mW

Caution: Exceeding Absolute Maximum Ratings may damage the module. These are not continuous operating ratings.

Model Selection Guide

Model Number	Input				Output			Load Regulation (% Max)	Efficiency (% Typ)	Fuse Rating Slow-Blow (mA)
	Voltage (VDC)		Current (mA)		Voltage (VDC)	Current (mA, Max)	Current (mA, Min)			
	Nominal	Range	Full-Load	No-Load						
LF101ED	5	4.5 - 5.5	277	30	±5.0	±100.0	±10.0	12.0	72	500
LF102ED	5	4.5 - 5.5	250	30	±9.0	±56.0	±6.0	8.0	75	500
LF103ED	5	4.5 - 5.5	256	30	±12.0	±42.0	±5.0	8.5	78	500
LF104ED	5	4.5 - 5.5	253	30	±15.0	±33.0	±4.0	7.0	79	500
LF111ED	12	10.8 - 13.2	112	15	±5.0	±100.0	±10.0	12.0	74	200
LF112ED	12	10.8 - 13.2	110	15	±9.0	±56.0	±6.0	8.0	76	200
LF113ED	12	10.8 - 13.2	105	15	±12.0	±42.0	±5.0	8.5	78	200
LF114ED	12	10.8 - 13.2	104	15	±15.0	±33.0	±4.0	7.0	79	200
LF151ED	3.3	3.0 - 3.6	452	55	±5.0	±100.0	±10.0	12.0	67	750
LF152ED	3.3	3.0 - 3.6	445	55	±12.0	±42.0	±5.0	8.5	68	750
LF153ED	3.3	3.0 - 3.6	432	55	±15.0	±33.0	±4.0	7.0	70	750

Notes:

1. Output load regulation is specified for a load change of 20% to 100%.
2. When measuring output ripple, it is recommended that an external 0.33 μF ceramic capacitor be placed from the +Vout pin to the -Vout pin for single output units and from each output to common for dual output units.
3. During operation, care must be taken not to exceed the specified input range of the unit or to allow the output load to drop below the specified minimum (10% of full load). Operating the unit under either of these conditions could cause damage to the unit.
4. These converters are specified for operation without external components. However, in some applications the addition of input/output capacitors will enhance stability and reduce output ripple. Recommended capacitor values are:

Vin	Input Capacitor	Vout	Output Capacitor
5 VDC	4.7 μF	5 VDC	4.7 μF
12 VDC	2.2 μF	9 VDC	2.2 μF
24 VDC	1.0 μF	12 VDC	1.0 μF
		15 VDC	0.47 μF

For applications requiring very low output noise levels, a simple LC filter should be effective.
 5. It is recommended that a fuse be used on the input of a power supply for protection. See the Model Selection table above for the correct rating.

Mechanical Dimensions

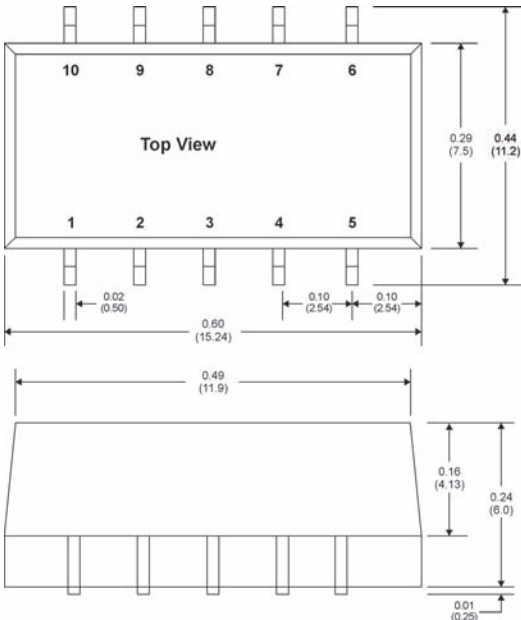

Pin Connections

Pin	Description	Pin	Description
1	-Vin	6	NC
2	+Vin	7	+Vout
3	NC	8	NC
4	Common	9	NC
5	-Vout	10	NC

NC = No Connection

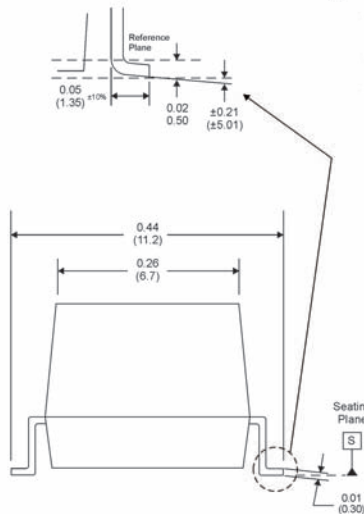

Notes:

- All dimensions are typical in inches (mm)
- Tolerance x.xx = ±0.01 (±0.25)
- Pin 1 is marked by a "dot" or indentation on the unit

Derating Curve

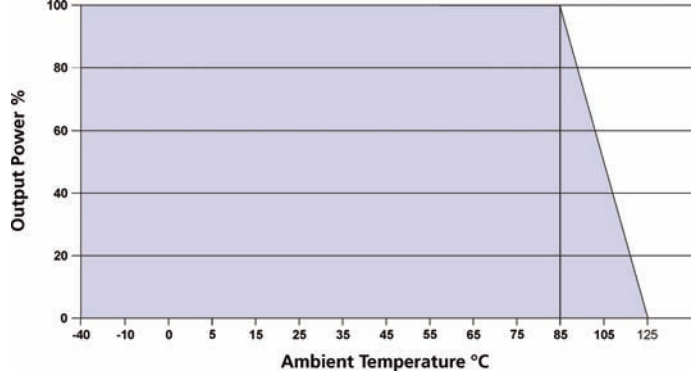

Recommended Solder Profile

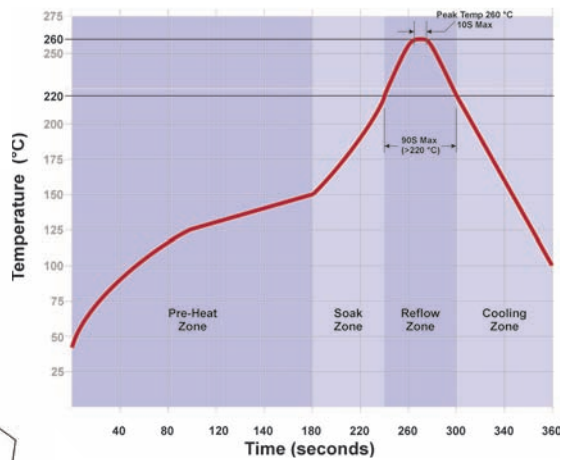

Board Layout

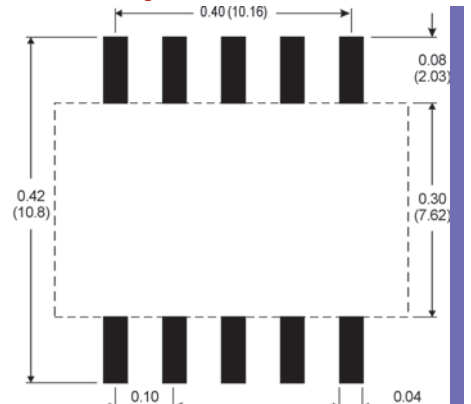

MicroPower Direct
www.micropowerdirect.com