

Types MC and MCN Multilayer RF Capacitors

High-Frequency, High-Power, High-Voltage Chips with Nonmagnetic Option

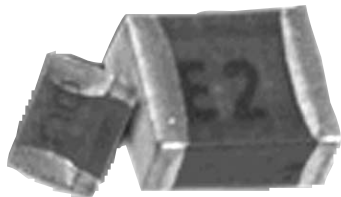

Rugged flexibility and compatibility with FR4 boards make Type MC and MCN capacitors ideal for use where other multilayer caps aren't recommended because of cracking. The natural mica dielectric retains its high-Q to many megahertz, so higher frequency applications are limited by the circuit inductance, not the Type MC capacitor. **Nonmagnetic** Type MCN chips are available for MRI and other high frequency applications that often use more expensive porcelain ceramic chips.

Highlights

- Extremely high Q at UHF/VHF frequencies
- Free from thermal cracking, FR4 compatible
- Wave solderable
- Nonmagnetic option
- Exceed 2 mm bend test
- Better than porcelain
- High RF current — dV/dt 20,000 V/μs
- Rock stable: No change with time, V & f

Applications

- MRI Coils and Generators
- RF Instruments
- Power Amplifiers
- Tuned LCR Circuits
- CATV
- Ground and Flight Mobile Radio
- Lasers
- Software - Defined Frequency-Hopping Radio

Specifications

- Voltages:** 100 Vdc, 500 Vdc, and 1000 Vdc
Capacitance Range: 0.5 pF to 2,200 pF
Capacitance Tolerance: ±0.25% to ±5%
Temperature Range: -55 °C to +125 °C
Case Sizes: 0805, 1210, 1812, and 2220

Ratings

RoHS Compliant

Cap (pF)	Catalog Part Number	Case Type	Cap (pF)	Catalog Part Number	Case Type	Cap (pF)	Catalog Part Number	Case Type
100 Vdc			100 Vdc			100 Vdc		
0.5	MC08CA0R5D-F	0805	68	MC08FA680J-F	0805	360	MC12FA361J-F	1210
1.0	MC08CA010D-F	0805	75	MC08FA750J-F	0805	390	MC12FA391J-F	1210
2.0	MC08CA020D-F	0805	82	MC08FA820J-F	0805	430	MC12FA431J-F	1210
3.0	MC08CA030D-F	0805	91	MC08FA910J-F	0805	250	MC18FA251J-F	1812
4.0	MC08CA040D-F	0805	100	MC08FA101J-F	0805	270	MC18FA271J-F	1812
5.0	MC08CA050D-F	0805	47	MC12FA470J-F	1210	300	MC18FA301J-F	1812
6.0	MC08CA060D-F	0805	50	MC12FA500J-F	1210	330	MC18FA331J-F	1812
7.0	MC08CA070D-F	0805	51	MC12FA510J-F	1210	360	MC18FA361J-F	1812
8.0	MC08CA080D-F	0805	56	MC12FA560J-F	1210	390	MC18FA391J-F	1812
9.0	MC08CA090D-F	0805	62	MC12FA620J-F	1210	430	MC18FA431J-F	1812
10.0	MC08CA100D-F	0805	68	MC12FA680J-F	1210	470	MC18FA471J-F	1812
12.0	MC08EA120J-F	0805	75	MC12FA750J-F	1210	500	MC18FA501J-F	1812
15.0	MC08EA150J-F	0805	82	MC12FA820J-F	1210	510	MC18FA511J-F	1812
18.0	MC08EA180J-F	0805	91	MC12FA910J-F	1210	560	MC18FA561J-F	1812
20.0	MC08EA200J-F	0805	100	MC12FA101J-F	1210	620	MC18FA621J-F	1812
22.0	MC08EA220J-F	0805	110	MC12FA111J-F	1210	680	MC18FA681J-F	1812
24.0	MC08EA240J-F	0805	120	MC12FA121J-F	1210	750	MC18FA751J-F	1812
27.0	MC08EA270J-F	0805	130	MC12FA131J-F	1210	820	MC18FA821J-F	1812
30.0	MC08EA300J-F	0805	150	MC12FA151J-F	1210	910	MC22FA911J-F	2220
33.0	MC08FA330J-F	0805	160	MC12FA161J-F	1210	1000	MC22FA102J-F	2220
36.0	MC08FA360J-F	0805	180	MC12FA181J-F	1210	1100	MC22FA112J-F	2220
39.0	MC08FA390J-F	0805	200	MC12FA201J-F	1210	1200	MC22FA122J-F	2220
43.0	MC08FA430J-F	0805	220	MC12FA221J-F	1210	1500	MC22FA152J-F	2220
47.0	MC08FA470J-F	0805	240	MC12FA241J-F	1210	1800	MC22FA182J-F	2220
50.0	MC08FA500J-F	0805	250	MC12FA251J-F	1210	2000	MC22FA202J-F	2220
51.0	MC08FA510J-F	0805	270	MC12FA271J-F	1210	2200	MC22FA222J-F	2220
56.0	MC08FA560J-F	0805	300	MC12FA301J-F	1210			
62.0	MC08FA620J-F	0805	330	MC12FA331J-F	1210			

Cap (pF)	Catalog Part Number	Case Type	Cap (pF)	Catalog Part Number	Case Type	Cap (pF)	Catalog Part Number	Case Type
500 Vdc			500 Vdc			500 Vdc		
0.5	MC08CD0R5D-F	0805	18	MC12ED180J-F	1210	130	MC18FD131J-F	1812
1	MC08CD010D-F	0805	20	MC12ED200J-F	1210	150	MC18FD151J-F	1812
2	MC08CD020D-F	0805	22	MC12ED220J-F	1210	160	MC18FD161J-F	1812
3	MC08CD030D-F	0805	24	MC12ED240J-F	1210	180	MC18FD181J-F	1812
4	MC08CD040D-F	0805	27	MC12ED270J-F	1210	200	MC18FD201J-F	1812
5	MC08CD050D-F	0805	30	MC12ED300J-F	1210	220	MC18FD221J-F	1812
6	MC08CD060D-F	0805	33	MC12FD330J-F	1210	240	MC18FD241J-F	1812
7	MC08CD070D-F	0805	36	MC12FD360J-F	1210	250	MC18FD251J-F	1812
8	MC08CD080D-F	0805	39	MC12FD390J-F	1210	270	MC18FD271J-F	1812
9	MC08CD090D-F	0805	43	MC12FD430J-F	1210	300	MC18FD301J-F	1812
10	MC08CD100D-F	0805	47	MC12FD470J-F	1210	330	MC18FD331J-F	1812
12	MC08ED120J-F	0805	50	MC12FD500J-F	1210	360	MC18FD361J-F	1812
15	MC08ED150J-F	0805	51	MC12FD510J-F	1210	390	MC18FD391J-F	1812
18	MC08ED180J-F	0805	56	MC12FD560J-F	1210	430	MC18FD431J-F	1812
20	MC08ED200J-F	0805	62	MC12FD620J-F	1210	470	MC18FD471J-F	1812
1	MC12CD010D-F	1210	68	MC12FD680J-F	1210	500	MC22FD501J-F	2220
2	MC12CD020D-F	1210	75	MC12FD750J-F	1210	510	MC22FD511J-F	2220
3	MC12CD030D-F	1210	82	MC12FD820J-F	1210	560	MC22FD561J-F	2220
4	MC12CD040D-F	1210	91	MC12FD910J-F	1210	620	MC22FD621J-F	2220
5	MC12CD050D-F	1210	100	MC12FD101J-F	1210	680	MC22FD681J-F	2220
6	MC12CD060D-F	1210	110	MC12FD111J-F	1210	750	MC22FD751J-F	2220
7	MC12CD070D-F	1210	120	MC12FD121J-F	1210	820	MC22FD821J-F	2220
8	MC12CD080D-F	1210	130	MC12FD131J-F	1210	910	MC22FD911J-F	2220
9	MC12CD090D-F	1210	150	MC12FD151J-F	1210	1000	MC22FD102J-F	2220
10	MC12CD100D-F	1210	100	MC18FD101J-F	1812	1100	MC22FD112J-F	2220
12	MC12ED120J-F	1210	110	MC18FD111J-F	1812	1200	MC22FD122J-F	2220
15	MC12ED150J-F	1210	120	MC18FD121J-F	1812			

Cap (pF)	Catalog Part Number	Case Type	Cap (pF)	Catalog Part Number	Case Type	Cap (pF)	Catalog Part Number	Case Type
1000 Vdc			1000 Vdc			1000 Vdc		
0.5	MC12CF0R5D-F	1210	39	MC12FF390J-F	1210	250	MC22FF251J-F	2220
1.0	MC12CF010D-F	1210	43	MC12FF430J-F	1210	270	MC22FF271J-F	2220
2.0	MC12CF020D-F	1210	47	MC12FF470J-F	1210	300	MC22FF301J-F	2220
3.0	MC12CF030D-F	1210	50	MC12FF500J-F	1210	330	MC22FF331J-F	2220
4.0	MC12CF040D-F	1210	51	MC22FF510J-F	2220	360	MC22FF361J-F	2220
5.0	MC12CF050D-F	1210	56	MC22FF560J-F	2220	390	MC22FF391J-F	2220
6.0	MC12CF060D-F	1210	62	MC22FF620J-F	2220	430	MC22FF431J-F	2220
7.0	MC12CF070D-F	1210	68	MC22FF680J-F	2220	470	MC22FF471J-F	2220
8.0	MC12CF080D-F	1210	75	MC22FF750J-F	2220	500	MC22FF501J-F	2220
9.0	MC12CF090D-F	1210	82	MC22FF820J-F	2220	510	MC22FF511J-F	2220
10.0	MC12CF100D-F	1210	91	MC22FF910J-F	2220	560	MC22FF561J-F	2220
12.0	MC12EF120J-F	1210	100	MC22FF101J-F	2220	620	MC22FF621J-F	2220
15.0	MC12EF150J-F	1210	110	MC22FF111J-F	2220	680	MC22FF681J-F	2220
18.0	MC12EF180J-F	1210	120	MC22FF121J-F	2220	750	MC22FF751J-F	2220
20.0	MC12EF200J-F	1210	130	MC22FF131J-F	2220	820	MC22FF821J-F	2220
22.0	MC12EF220J-F	1210	150	MC22FF151J-F	2220	910	MC22FF911J-F	2220
24.0	MC12EF240J-F	1210	160	MC22FF161J-F	2220	1000	MC22FF102J-F	2220
27.0	MC12EF270J-F	1210	180	MC22FF181J-F	2220	1100	MC22FF112J-F	2220
30.0	MC12EF300J-F	1210	200	MC22FF201J-F	2220	1200	MC22FF122J-F	2220
33.0	MC12FF330J-F	1210	220	MC22FF221J-F	2220	1500	MC22FF152J-F	2220
36.0	MC12FF360J-F	1210	240	MC22FF241J-F	2220			

Types MC and MCN Multilayer RF Capacitors

Part Numbering System and Ordering Information

Order by complete part number, as below. For other options, write your requirement on your RFQ.

MC(N) CDE Type	22 Case Code	F Temperature Coefficient	D Voltage	122 Capacitance	J Capacitor Tolerance	- Package	F RoHS (MC only)
MC = Standard	08 = 0805		A = 100 Vdc	010 = 1 pF		Blank = Bulk	MCN complies (no F required)
MCN = Nonmagnetic	12 = 1210		D = 500 Vdc	1R8 = 1.8 pF		T = Tape & reel	
	18 = 1812		F = 1000 Vdc	(187) = 187 pF		not specific	
	22 = 2220			182 = 1800 pF			

TC Code	Capacitance Range (pF)	Temperature Coefficient ppm/°C	Capacitance Drift
C	0.5 to 10	100 ±100	±(0.5% +0.1 pF)
E	10.5 to 30	50 ±50	±(0.1% +0.1 pF)
F	30.5 & up	25 ±25	±(0.05% +0.1 pF)

Tol. Code	Tolerance	Capacitance Range
B	±0.1 pF	0.5 pF to 5 pF
C	±0.25 pF	0.5 pF to 99.5 pF
C	±0.25%	100 pF and up
D	±0.5 pF	0.5 pF to 10 pF
D	±0.50%	50.5 pF and up
F	±1 pF	5.5 pF to 10 pF
F	±1%	25.5 pF and up
G	±2%	13.0 pF and up
J	±5%	10.5 pF and up

Available Capacitance Values

Case Code	Capacitance (pF)			Minimum Cap. Step, pF
	100 Vdc	500 Vdc	1000 Vdc	
08	0.5 to 100	0.5 to 20	N/A	0.5
12	43.5 to 100	0.5 to 100	N/A	0.5
12	101 to 430	101 to 150	N/A	1.0
12			0.5 to 50	1.0
18	241 to 820	91.5 to 470	N/A	1.0
22	821 to 1000	471 to 1000	N/A	1.0
22	1010 to 2200	1010 to 1200	50.5 to 1500	10.0

Standard Minimum Quantities

Reel Packed
Case Codes 08 & 12: 3,000/reel*
Case Codes 18 & 22: 1,000/reel**
Bulk Packed
100 per bag

*note - MC12, 100 volt units -250 pF and above, and 500 volt units -100 pF and above 2000 pc reels

**note - MC22, 1000 volt units -680 pF and above 500 pc reels

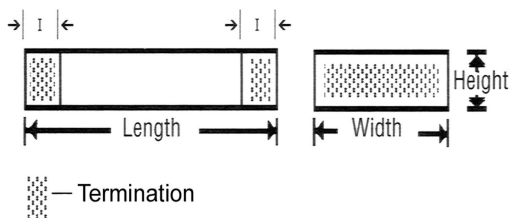

Case Sizes

Case Code	Case Type	INCHES				MILLIMETERS			
		L	W	H (Max.)	I Min./Max.	L	W	H (Max.)	I Min./Max.
08	0805	0.079 +0.02 -0	0.049 +0.02 -0	0.055	0.008/0.035	2.0 +0.5 -0	1.25 +0.5 -0	1.4	0.2/0.9
12	1210	0.126 +0.024 -0.004	0.098 +0.024 -0.004	0.079	0.012/0.043	3.2 +0.6 -0.1	2.5 +0.6 -0.1	2.0	0.3/1.1
18	1812	0.177 +0.024 -0.008	0.126 +0.024 -0	0.079	0.012/0.051	4.5 +0.6 -0.2	3.2 +0.6 -0	2.0	0.3/1.3
22	2220	0.224 +0.016 -0.012	0.197 +0.016 -0.012	0.079	0.012/0.051	5.7 +0.4 -0.3	5.0 +0.4 -0.3	2.0*	0.3/1.3

*.157 (4.0 mm) for 1000 V rating

Types MC and MCN Multilayer RF Capacitors

Typical Performance Curves

Type MC Typical ESR vs. Frequency

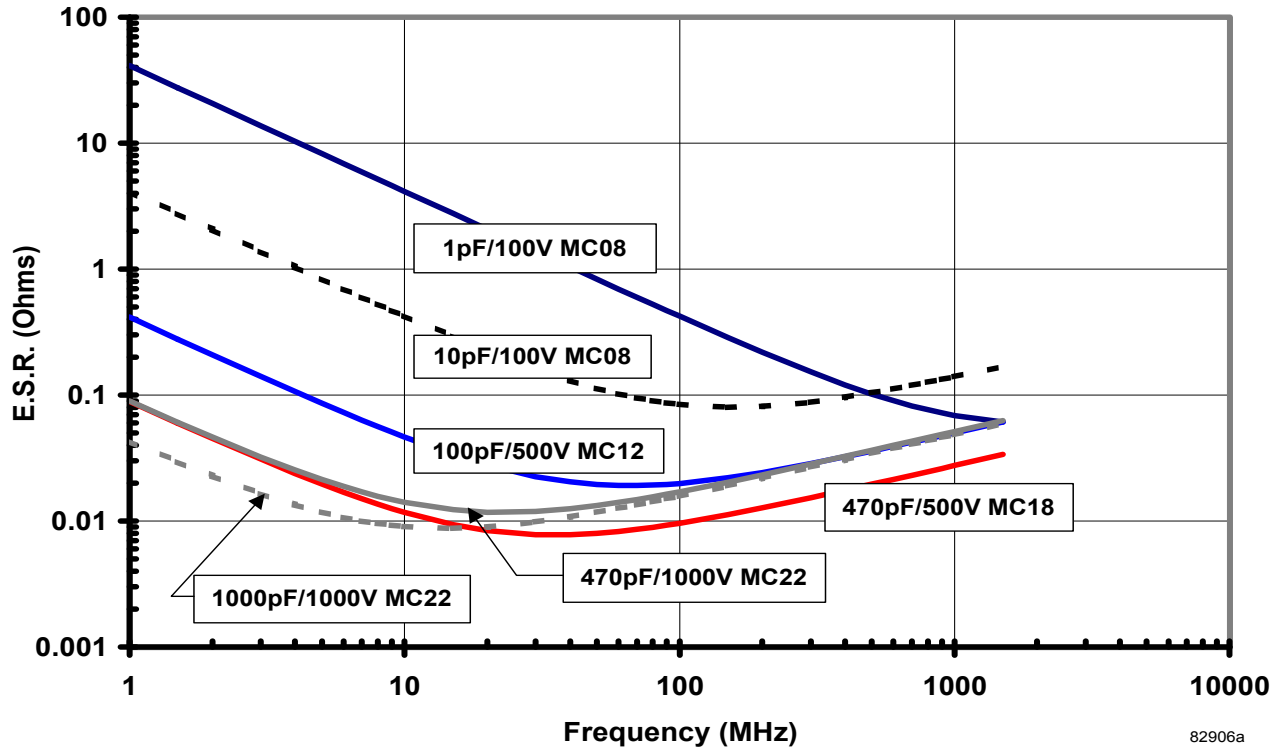

Type MC Maximum RMS Current vs. Frequency

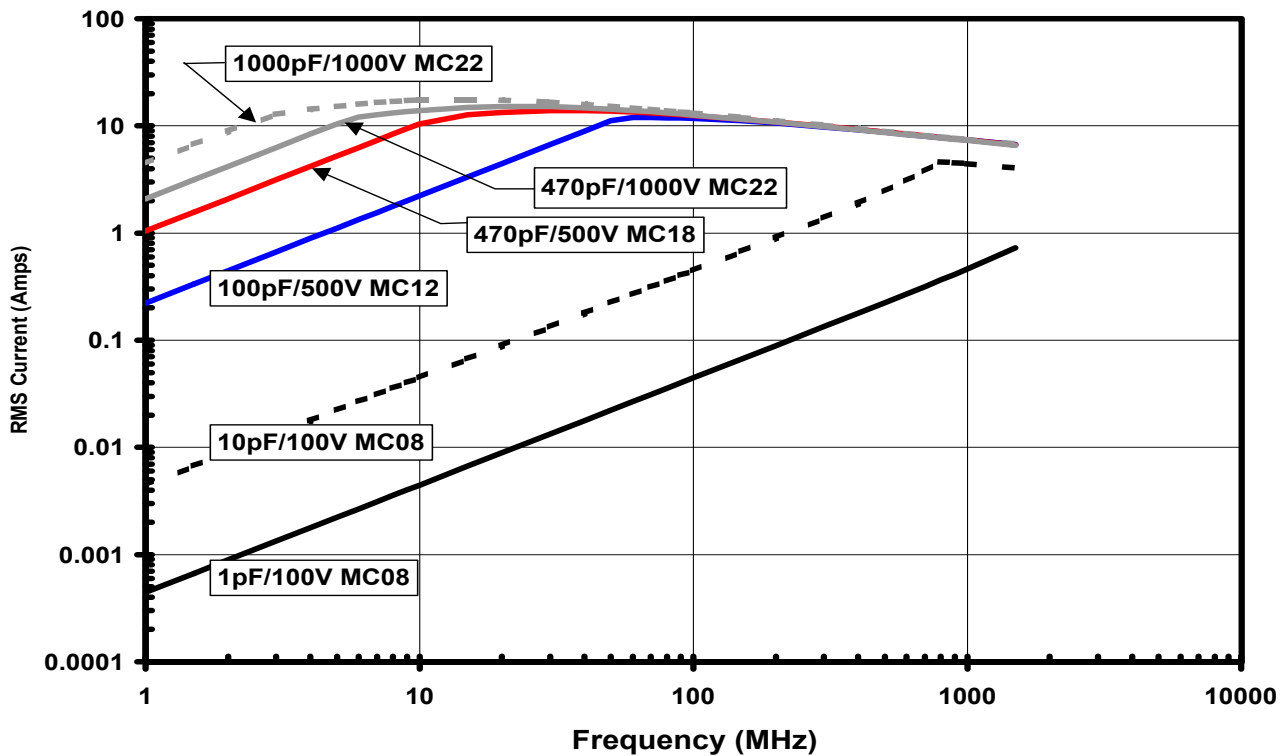

Typical Performance Curves

Type MC Typical Q vs. Frequency

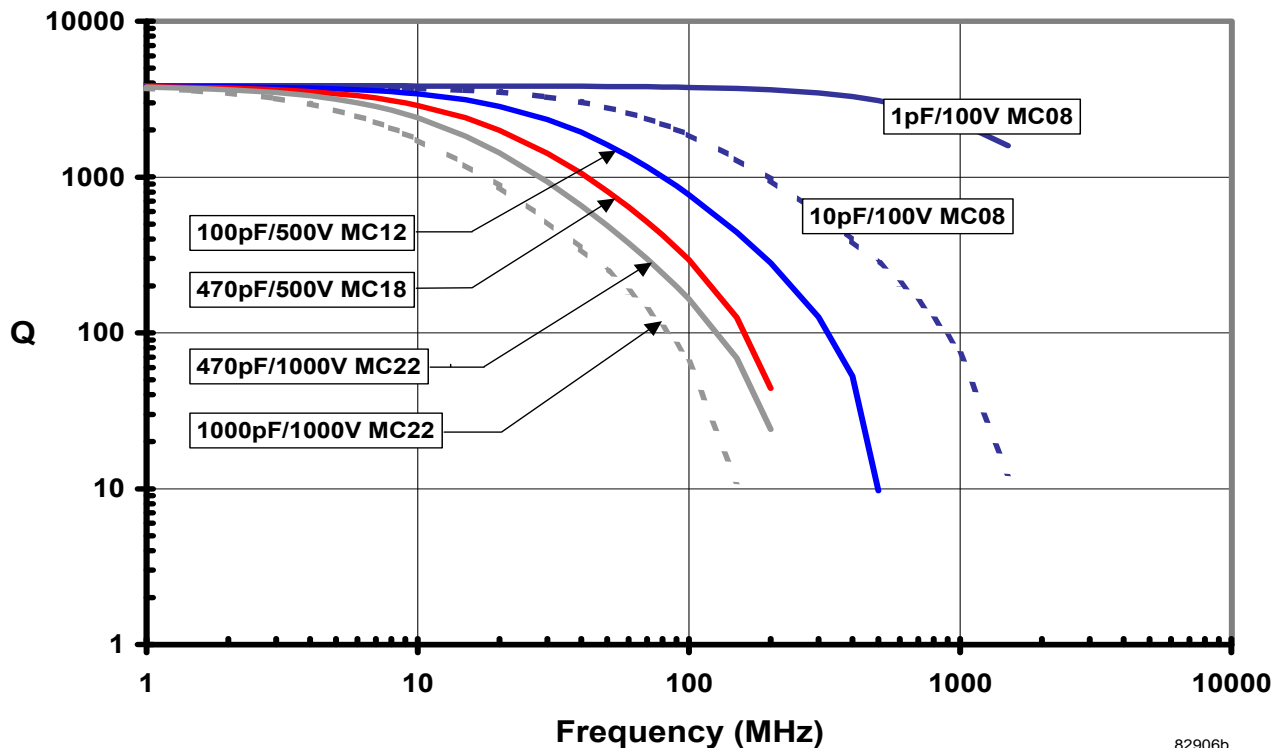

Type MC Typical Impedance vs. Frequency

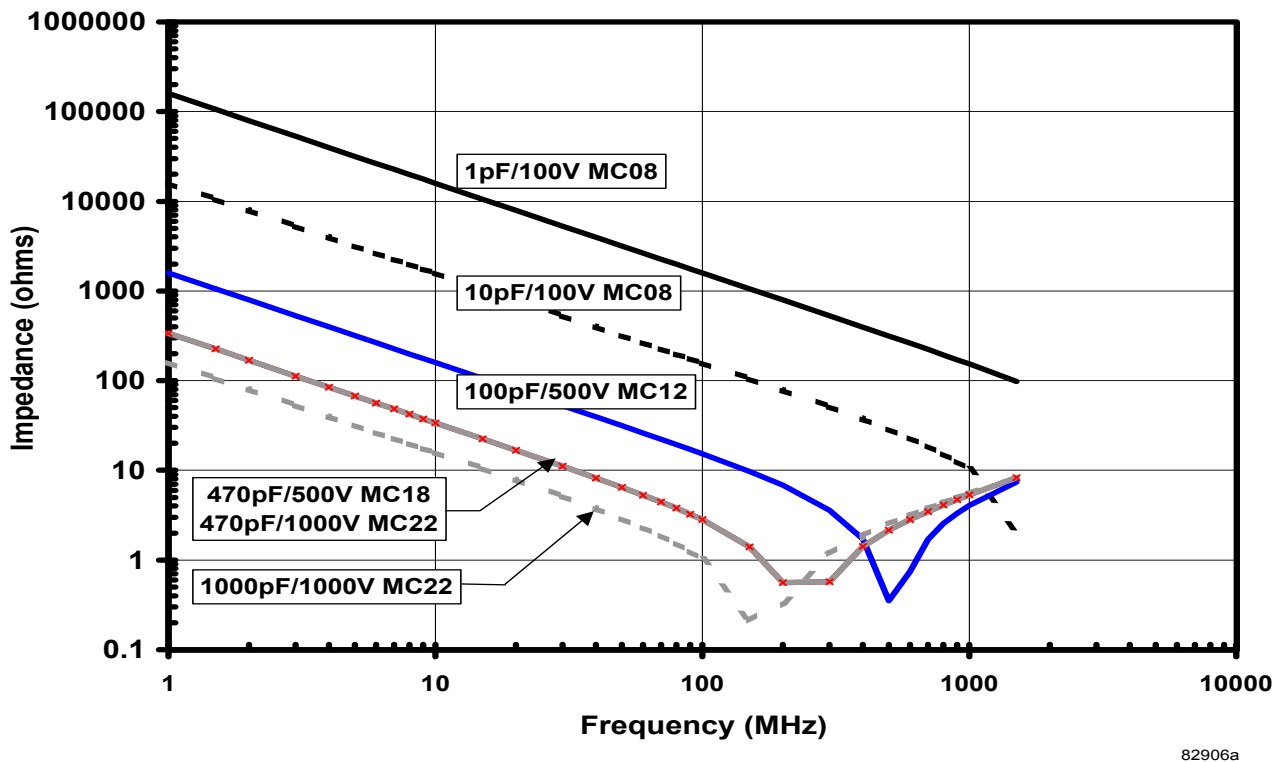

Types MC and MCN **Multilayer RF Capacitors**

High Q, Low ESR Construction for RF Power Applications

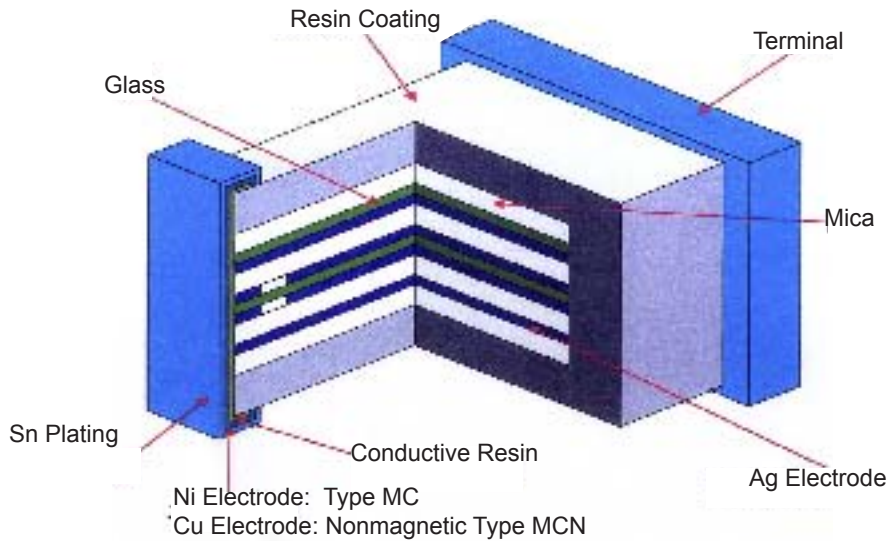

Specifications

Marking

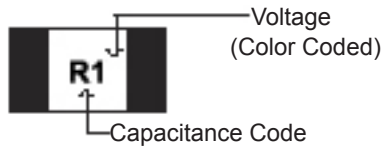

Base Value	Code Ltr.	Base Value	Code Ltr.
10	A	40	d
11	B	43	R
12	C	45	e
13	D	47	S
15	E	50	f
16	F	51	T
18	G	56	U
20	H	60	m
22	J	62	V
24	K	68	W
25	a	70	n
27	L	75	X
30	M	80	t
33	N	82	Y
35	b	90	y
36	P	91	Z
39	Q		

Capacitance is within tolerance when measured as follows:

1—1000 pF @ 1 MHz
>1000 pF @ 1 kHz

Dissipation Factor is no more than 0.1% when measured as above at 5 Vrms or less.

Multiplier	Code No.
X 0.1	0
X 1	1
X 10	2
X 100	3
X 0.01	9

Example:
R1 = 43 pF

Specifications

Quality Factor (Q) is as follows when measured at 1 MHz

Capacitance Range	Min. Q
1 to 80 pF	500 to 3000
>80 pF	3000

Insulation Resistance is no less than 100 GΩ when measured at 100 Vdc

Withstanding voltage is two times the rated voltage between 5 seconds and without damage: with 50 mA or less current.

Life Test: Subject capacitors to 125 °C ±3 °C with 1.5 times rated voltage applied for 2000 (+72, -0) hours. There will be no visual damage and the capacitors will meet the limits of the table below.

Vibration Resistance: Subject the capacitors to simple harmonic motion with an amplitude of 0.06 inches; vary the frequency uniformly from 10 to 55 Hz and return to 10 Hz, all in one minute. Repeat that cycle continuously for two hours in

each of three mutually perpendicular directions. There will be no visual damage and the capacitors will meet the limits of the table below.

Bending Test: Mount the capacitor as shown below and press the ram bar until a 2.0 mm deflection is achieved. There will be no visual damage and the capacitors will meet the limits of methods JIS 5102 8.11 and AEC-Q200-005 without cracking or visual damage.



Moisture Resistance: Subject the capacitors to 40 ±2 °C at 90 to 95% humidity for 500 (+24, -0) hours. Return to room ambient for 24 hours. There will be no visual damage and the capacitors will meet the limits of the table below.

Temperature Coefficient and Drift: Measure the capacitors' capacitance at 25 °C, -55 °C, 25 °C, 125 °C and at 25 °C — all ±3 °C — after stabilizing at each temperature. The capacitor will meet the limits of the Characteristic table in Ordering Information.

Heat Resistance: Subject the capacitors to 125 ±2 °C for 2 (+1, -0) hours. Then the insulation resistance will be no less than 5GΩ.

Solderability: After 2 ±0.5 seconds in molten solder with Sn-PB between molten and solder at 235 ±5 °C, solder coverage will be no less than 75% when examined at 10X magnification for flow soldering.

Solder Heat Resistance: Subject the capacitors to molten solder at 250±5 °C for 5±0.5 seconds after 10 to 30 seconds pre-heating at 80 to 120 °C. There will be no visual damage and the capacitors will meet the limits of the table below.

After-Test Limits

Test	Withstand Voltage	Insulation Resistance	Capacitance (whichever >)	DF	Q
Life Test	IL	IL	IV ±2% or ±.5 pF	150% max IL	2/3 x IL
Vibration Resistance	IL	30 GΩ	IV ±1% or ±1 pF	IL	IL
Bending Test	IL		IV ±.5% or ±1 pF	IL	
Moisture Res.	IL	30 GΩ	IV ±3% or ±.5 pF	150% max IL	2/3 x IL
Solderability	IL	IL	IL	IL	IL
Heat Resistance		5 GΩ			
Solder Heat Res.	IL	30 GΩ	IV ±.5% or ±1 pF	IL	IL

Types MC and MCN **Multilayer RF Capacitors**

Soldering Profiles

Reflow Solder Profile

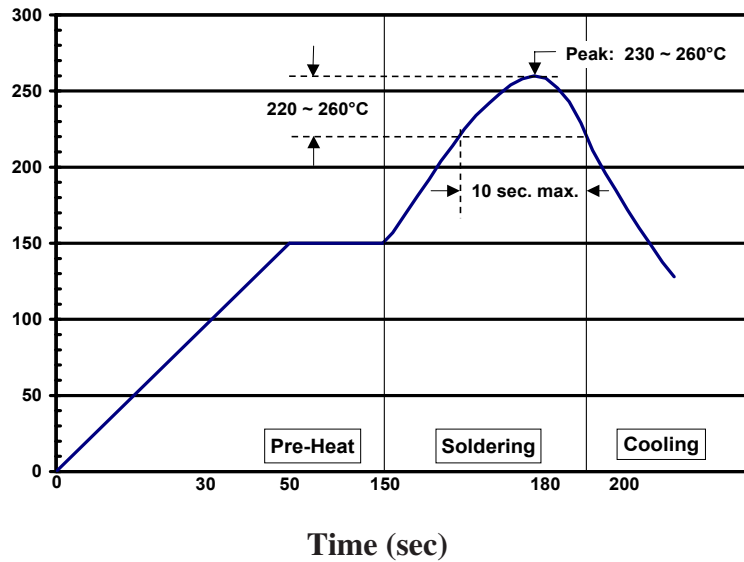

Wave Solder Profile

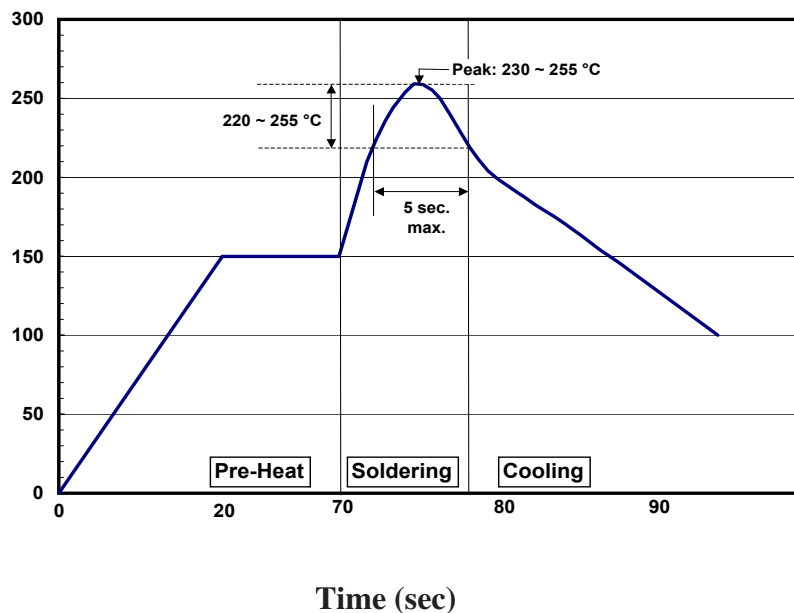

Hand Soldering Method

- SnAgCu recommended solder
- Do not use strong acid type flux with RM or RMA
- Soldering iron tip temperature should be 250 °C to 280 °C ≤ 5 sec.
- 60 Watt iron or less

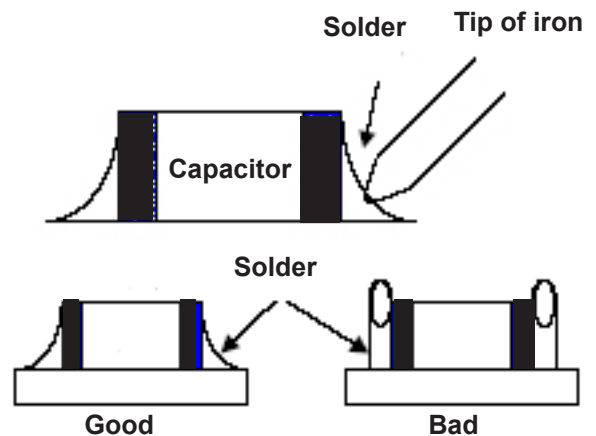

Types MC and MCN Multilayer RF Capacitors

Surface-Mount Chip Mica Capacitors for Auto Insertion

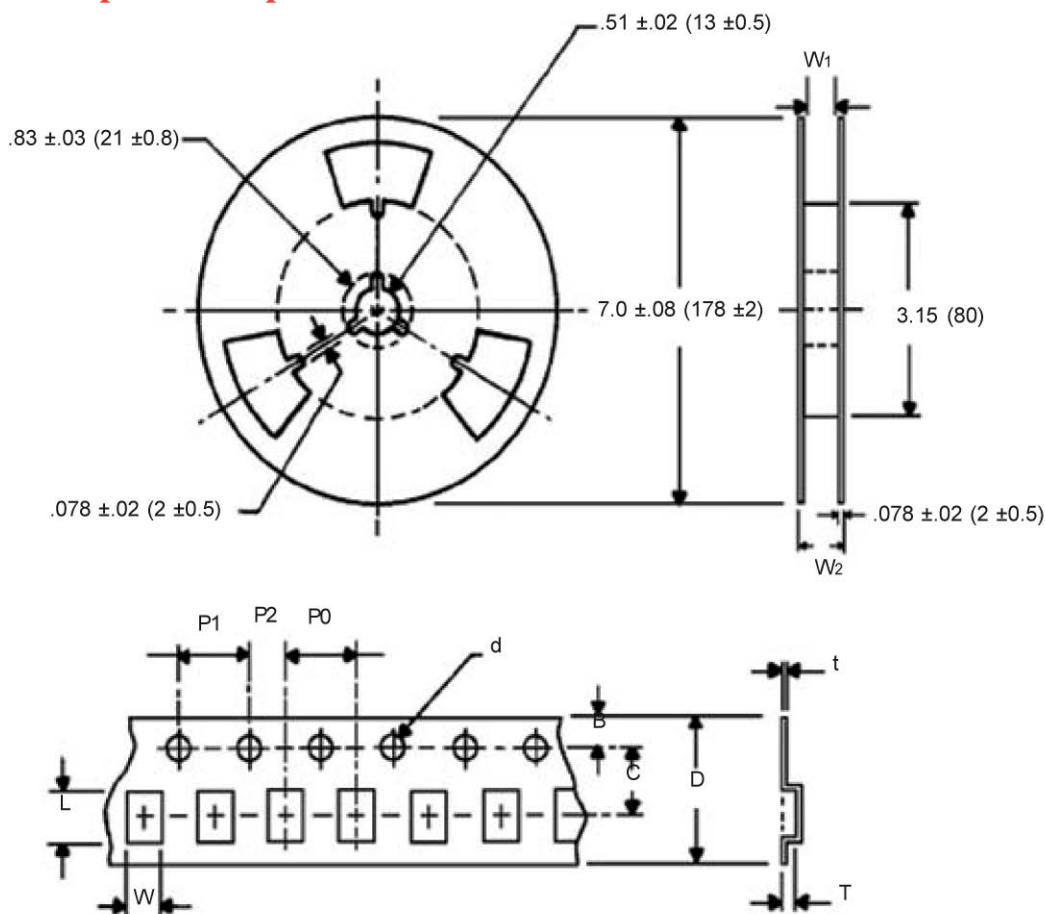

Carrier Dimensions

Item	Symbol	Case Code							
		08		12		18		22	
Sprocket hole pitch	P1	.157 ± 0.008 (4.0 ± 0.2)							
Sprocket hole location	B	.069 ± 0.008 (1.75 ± 0.2)							
Hole center to cavity center	C	.138 ± 0.002 (3.5 ± 0.05)				.217 ± 0.004 (5.5 ± 0.1)			
Carrier tape width	D	.315 ± 0.012 (8.0 ± 0.3)				.472 ± 0.012 (12.0 ± 0.3)			
Sprocket hole diameter	d	.059 (1.5)							
Cavity pitch	P ₀	.157 ± 0.004 (4.0 ± 0.1)				.315 ± 0.008 (8.0 ± 0.2)			
Hole center to cavity center	P ₂	.079 ± 0.004 (2.0 ± 0.1)							
Cavity length	L	.110	(2.8)	.150	(3.8)	.205	(5.2)	.246	(6.25)
Cavity width	W	.075 ± 0.008 (1.9 ± 0.2)		.118 ± 0.008 (3.0 ± 0.2)		.161 ± 0.008 (4.1 ± 0.2)		.217 ± 0.008 (5.5 ± 0.2)	
Cavity depth	T	.051 ± 0.004 (1.3 ± 0.1)		.059 ± 0.004 (1.5 ± 0.1)		.071 ± 0.004 (1.8 ± 0.1)		.087 ± 0.004 (2.2 ± 0.1)	
Carrier tape thickness	t	.012 ± 0.002 (0.3 ± 0.05)							
Holder distance	W ₁	.354	(9.0)					.512	(13.0)
Reel thickness	W ₂	about .47 (12)				about .63 (16)			