

A1147 and A1148

Low Current Ultrasensitive Two-Wire Chopper-Stabilized Unipolar Hall Effect Switches

Package LH, 3-pin SOT

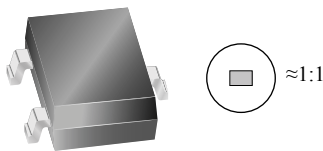

Package UA, 3-pin SIP

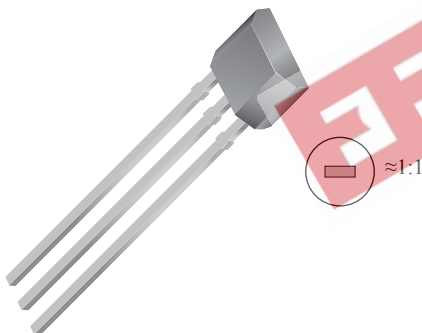

ABSOLUTE MAXIMUM RATINGS

Supply Voltage, V_{CC}	28 V
Reverse-Supply Voltage, V_{RCC}	-18 V
Magnetic Flux Density, B	Unlimited
Power Dissipation, P_D	Graph, p. 5
Operating Temperature	
Ambient, T_A , Range E	-40°C to 85°C
Ambient, T_A , Range L	-40°C to 150°C
Maximum Junction, $T_{J(max)}$	165°C
Storage Temperature, T_S	-65°C to 170°C

The A1147 and A1148 devices are two-wire, unipolar, Hall effect switches that are factory-programmed at end-of-line to optimize ultrasensitive magnetic switchpoint accuracy. These devices use a patented high frequency chopper-stabilization technique, produced using the Allegro advanced BiCMOS wafer fabrication process, to achieve magnetic stability and to eliminate offset inherent in single-element devices exposed to harsh application environments.

Commonly found in a number of automotive applications, these switches are utilized to sense seat track position, seat belt buckle presence, hood/trunk latching, and shift selector position. Two-wire unipolar switches, such as the A1147 and A1148, are particularly advantageous in price-sensitive applications because they require one less wire for operation than do switches with the more traditional open-collector output. Additionally, the system designer inherently gains diagnostics because there is always output current flowing, which should be in either of two narrow ranges. Any current level not within these ranges indicates a fault condition. These devices also feature on-chip transient protection and a Zener clamp to protect against overvoltage conditions on the supply line.

The output currents of the A1148 switches HIGH in the presence of a south (+) polarity magnetic field of sufficient strength, and switches LOW otherwise, as in the presence of a weak field or a north (-) polarity field. The A1147 has an opposite output: the currents switch LOW in the presence of a south-polarity magnetic field of sufficient strength, and switch HIGH otherwise.

Both versions are offered in two package styles. The LH is a SOT-23W, miniature low-profile package for surface-mount applications. The UA is a three-lead ultra-mini SIP for through-hole mounting. Each package is available in a lead (Pb) free version (suffix, -T) with 100% matte tin plated leadframe. Field-programmable versions also available: A1180 and A1181.

Features and Benefits

- Chopper stabilization
 - Low switchpoint drift over operating temperature range
 - Low sensitivity to stress
- Factory programmed at end-of-line for optimized switchpoints
- On-chip protection
 - Supply transient protection
 - Reverse-battery protection
 - On-board voltage regulator
 - 3.5 to 24 V operation



A1147 and A1148

Low Current Ultrasensitive Two-Wire Chopper-Stabilized Unipolar Hall Effect Switches

Functional Block Diagram

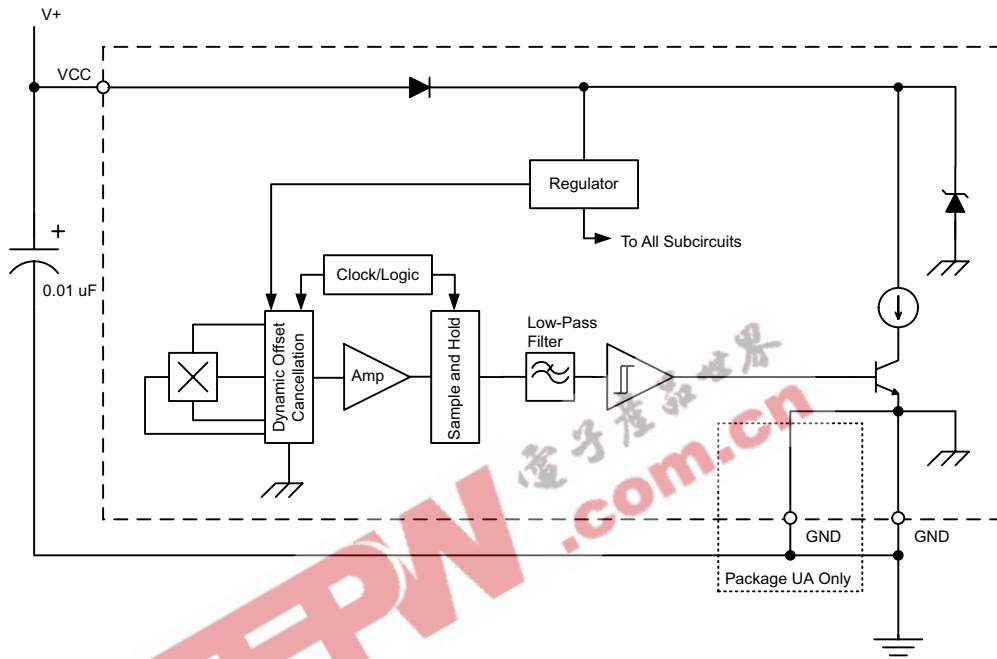

Package LH, 3-pin SOT

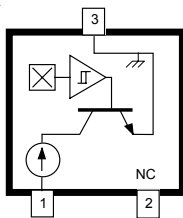

1. VCC
2. No connection
3. GND

Package UA, 3-pin SIP

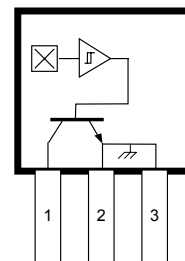

1. VCC
2. GND
3. GND

A1147 and A1148

Low Current Ultrasensitive Two-Wire Chopper-Stabilized Unipolar Hall Effect Switches

ELECTRICAL CHARACTERISTICS over the operating voltage and temperature ranges, unless otherwise specified

Characteristic	Symbol	Test Conditions	Min.	Typ.	Max.	Units
Supply Voltage ¹	V_{CC}		3.5	–	24	V
Supply Current ²	I_{CCL}	$B > B_{OP}$ for A1147; $B < B_{RP}$ for A1148	2	–	5	mA
	I_{CCH}	$B > B_{OP}$ for A1148; $B < B_{RP}$ for A1147	12	–	17	mA
Reverse Supply Current	I_{RCC}	$V_{RCC} = -18$ V	–	–	-1.6	mA
Supply Zener Clamp Voltage	$V_{ZSUPPLY}$	$I_{CC} = I_{CCL(max)} + 3$ mA; $T_A = 25^\circ\text{C}$	28	–	40	V
Supply Zener Clamp Current ³	$I_{ZSUPPLY}$	$V_{ZSUPPLY} = 28$ V	–	–	8	mA
Output Slew Rate ⁴	di/dt	Capacitance of the oscilloscope performing the measurement = 20 pF	–	36	–	mA/ μs
Chopping Frequency	f_C		–	200	–	kHz
Power-On Time ⁵	t_{on}	$C_{BYPASS} = 0.01$ μF	–	–	25	μs
Power-On State ^{6,7}	POS	$t < t_{on}$; V_{CC} slew rate > 25 mV/ μs	–	HIGH	–	–

¹ V_{CC} represents the generated voltage between the VCC pin and the GND pin.

²Relative values of B use the algebraic convention, where positive values indicate south magnetic polarity, and negative values indicate north magnetic polarity; therefore greater B values indicate a stronger south polarity field (or a weaker north polarity field, if present).

³ $I_{ZSUPPLY(max)} = I_{CCL(max)} + 3$ mA.

⁴Measured without bypass capacitor between VCC and GND. Use of a bypass capacitor results in slower current change.

⁵Measured with and without bypass capacitor of 0.01 μF . Adding a larger bypass capacitor causes longer Power-On Time.

⁶POS is defined as true only with a V_{CC} slew rate of 25 mV/ μs or greater. Operation with a V_{CC} slew rate less than 25 mV/ μs can permanently harm device performance.

⁷POS is undefined for $t > t_{on}$ or $B_{RP} < B < B_{OP}$.

MAGNETIC CHARACTERISTICS over the operating voltage and temperature ranges, unless otherwise specified

Characteristic	Symbol	Test Conditions	Min.	Typ.*	Max.	Units
Operate Point	B_{OP}	A1147 $I_{CC} = I_{CCL}$	20	37	80	G
		A1148 $I_{CC} = I_{CCH}$				
Release Point	B_{RP}	A1147 $I_{CC} = I_{CCH}$	10	22	60	G
		A1148 $I_{CC} = I_{CCL}$				
Hysteresis	B_{HYS}	$B_{HYS} = B_{OP} - B_{RP}$	5	15	30	G

*Typical data are for initial design estimations only, and assume optimum manufacturing and application conditions, such as $T_A = 25^\circ\text{C}$ and $V_{CC} = 12$ V. Performance may vary for individual units, within the specified maximum and minimum limits.

A1147 and A1148

Low Current Ultrasensitive Two-Wire Chopper-Stabilized Unipolar Hall Effect Switches

Characteristic Data

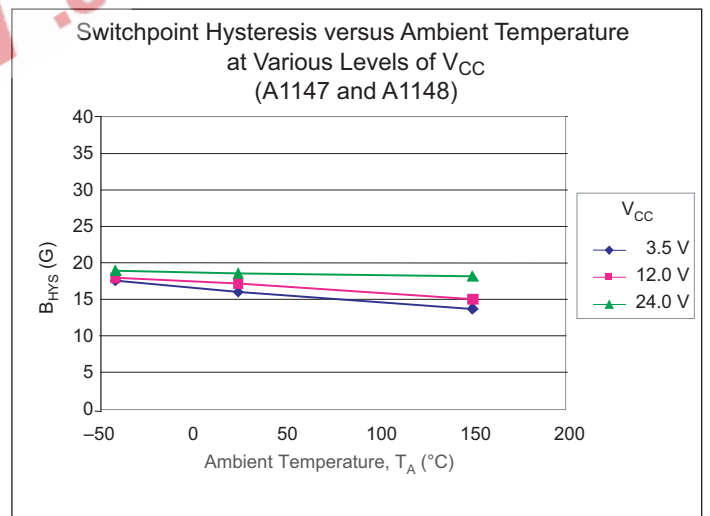
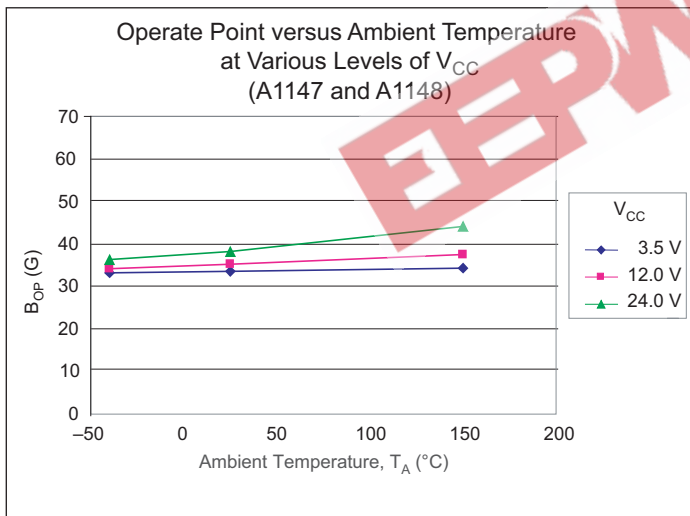
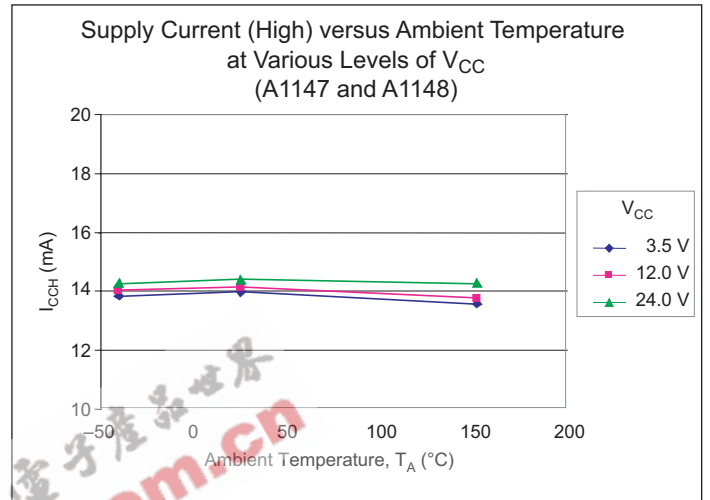
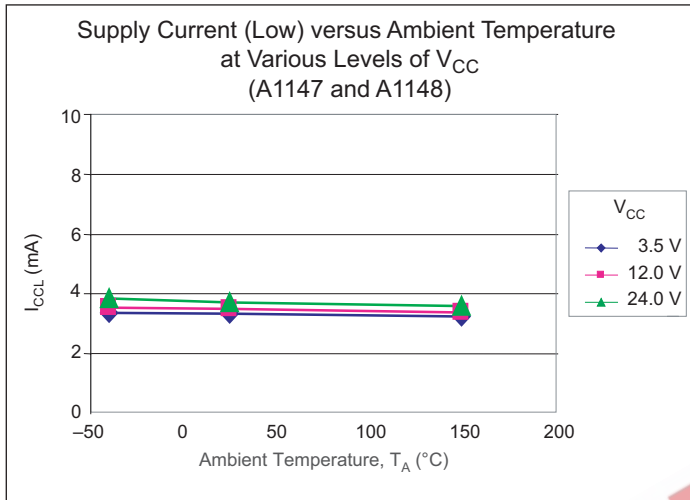

A1147 and A1148

Low Current Ultrasensitive Two-Wire Chopper-Stabilized Unipolar Hall Effect Switches

THERMAL CHARACTERISTICS may require derating at maximum conditions, see application information

Characteristic	Symbol	Test Conditions*	Value	Units
Package Thermal Resistance	$R_{\theta JA}$	Package LH, 1-layer PCB with copper limited to solder pads	228	°C/W
		Package LH, 2-layer PCB with 0.463 in. ² of copper area each side connected by thermal vias	110	°C/W
		Package UA, 1-layer PCB with copper limited to solder pads	165	°C/W

*Additional thermal information available on Allegro Web site.

Power Derating Curve

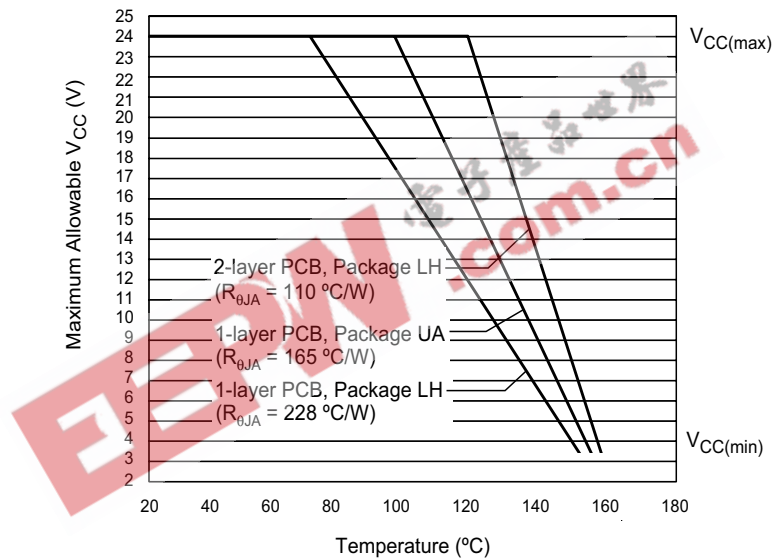

Power Dissipation versus Ambient Temperature

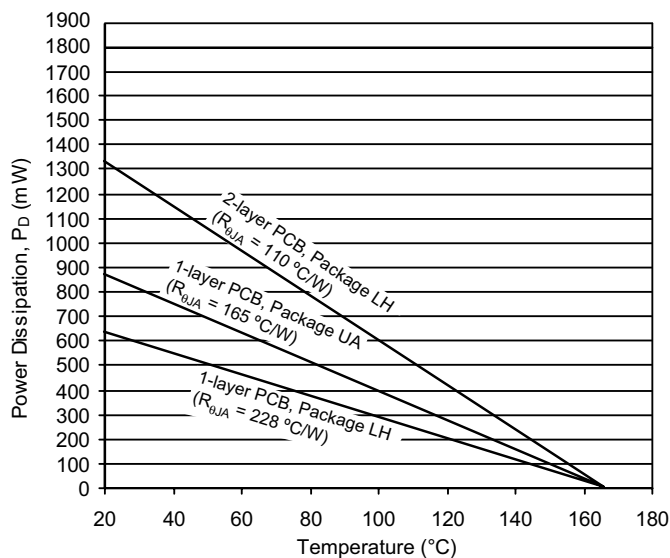

A1147 and A1148

Low Current Ultrasensitive Two-Wire Chopper-Stabilized Unipolar Hall Effect Switches

Functional Description

Operation

The output, I_{CC} , of the A1147 device switches low after the magnetic field at the Hall sensor exceeds the operate point threshold, B_{OP} . When the magnetic field is reduced to below the release point threshold, B_{RP} , the device output goes high. The differences between the magnetic operate and release point is called the hysteresis of the device, B_{HYS} . This built-in hysteresis allows

clean switching of the output even in the presence of external mechanical vibration and electrical noise. The A1148 device switches with opposite polarity for similar B_{OP} and B_{RP} values, in comparison to the A1147 (see figure 1).

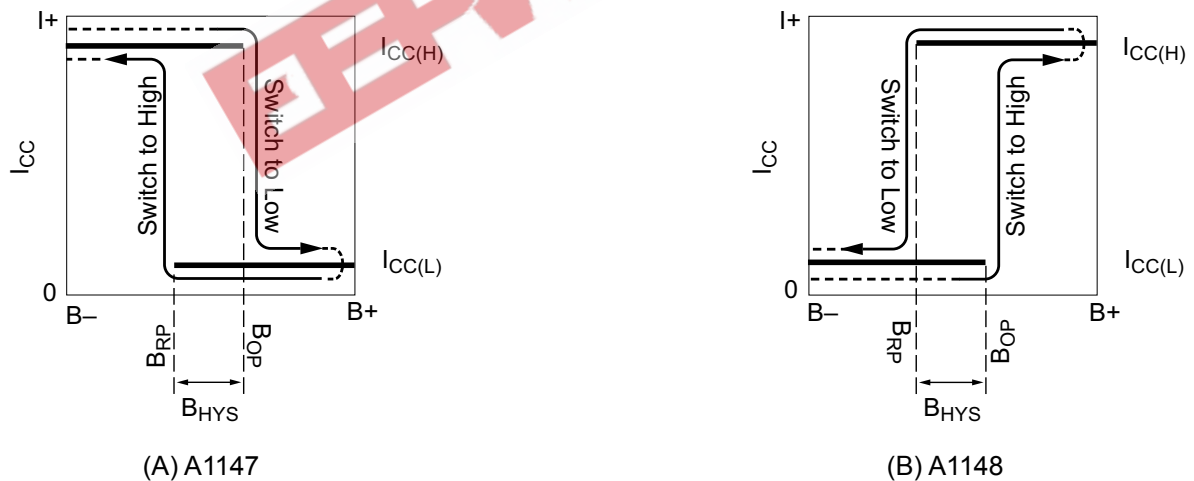

Figure 1. Alternative switching behaviors are available in the A114x device family. On the horizontal axis, the B+ direction indicates increasing south polarity magnetic field strength, and the B- direction indicates decreasing south polarity field strength (including the case of increasing north polarity).

A1147 and A1148

Low Current Ultrasensitive Two-Wire Chopper-Stabilized Unipolar Hall Effect Switches

Chopper Stabilization Technique

When using Hall-effect technology, a limiting factor for switchpoint accuracy is the small signal voltage developed across the Hall element. This voltage is disproportionately small relative to the offset that can be produced at the output of the Hall sensor. This makes it difficult to process the signal while maintaining an accurate, reliable output over the specified operating temperature and voltage ranges.

Chopper stabilization is a unique approach used to minimize Hall offset on the chip. The patented Allegro technique, namely Dynamic Quadrature Offset Cancellation, removes key sources of the output drift induced by thermal and mechanical stresses. This offset reduction technique is based on a signal modulation-demodulation process. The undesired offset signal is separated from the magnetic field-induced signal in the frequency domain, through modulation. The subsequent demodulation acts as a modulation process for the offset, causing the magnetic field-induced signal to recover its original spectrum at baseband, while the dc offset becomes a high-frequency signal. The magnetic-sourced signal then can pass through a low-pass filter, while the modulated dc offset is suppressed. This configuration is illustrated in figure 2.

The chopper stabilization technique uses a 200 kHz high frequency clock. For demodulation process, a sample and hold technique is used, where the sampling is performed at twice the chopper frequency (400 kHz). This high-frequency operation allows a greater sampling rate, which results in higher accuracy and faster signal-processing capability. This approach desensitizes the chip to the effects of thermal and mechanical stresses, and produces devices that have extremely stable quiescent Hall output voltages and precise recoverability after temperature cycling. This technique is made possible through the use of a BiCMOS process, which allows the use of low-offset, low-noise amplifiers in combination with high-density logic integration and sample-and-hold circuits.

The repeatability of magnetic field-induced switching is affected slightly by a chopper technique. However, the Allegro high-frequency chopping approach minimizes the affect of jitter and makes it imperceptible in most applications. Applications that are more likely to be sensitive to such degradation are those requiring precise sensing of alternating magnetic fields; for example, speed sensing of ring-magnet targets. For such applications, Allegro recommends its digital sensor families with lower sensitivity to jitter. For more information on those devices, contact your Allegro sales representative.

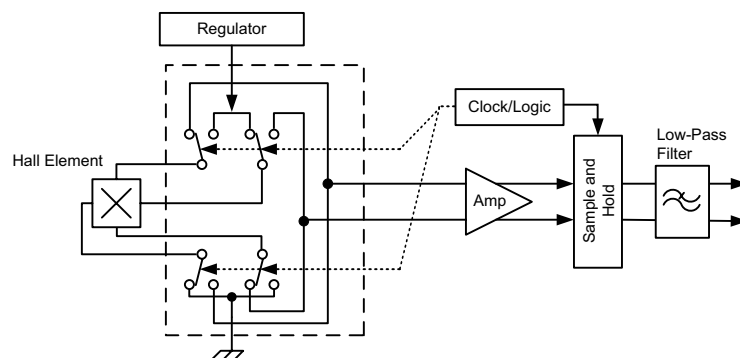

Figure 2. Chopper stabilization circuit (Dynamic Quadrature Offset Cancellation)

A1147 and A1148

Low Current Ultrasensitive Two-Wire Chopper-Stabilized Unipolar Hall Effect Switches

Application Information

Typical Application Circuit

The A114x family of devices must be protected by an external bypass capacitor, C_{BYP} , connected between the supply, V_{CC} , and the ground, GND , of the device. C_{BYP} reduces both external noise and the noise generated by the chopper-stabilization function. As shown in figure 3, a $0.01 \mu F$ capacitor is typical.

Installation of C_{BYP} must ensure that the traces that connect it to the A114x pins are no greater than 5 mm in length.

All high-frequency interferences conducted along the supply lines are passed directly to the load through C_{BYP} , and it serves only to protect the A114x internal circuitry. As a result, the load ECU (electronic control unit) must have sufficient protection, other than C_{BYP} , installed in parallel with the A114x.

A series resistor on the supply side, R_S (not shown), in combination with C_{BYP} , creates a filter for EMI pulses.

When determining the minimum V_{CC} requirement of the A114x device, the voltage drops across R_S and the ECU sense resistor, R_{SENSE} , must be taken into consideration. The typical value for R_{SENSE} is approximately 100Ω .

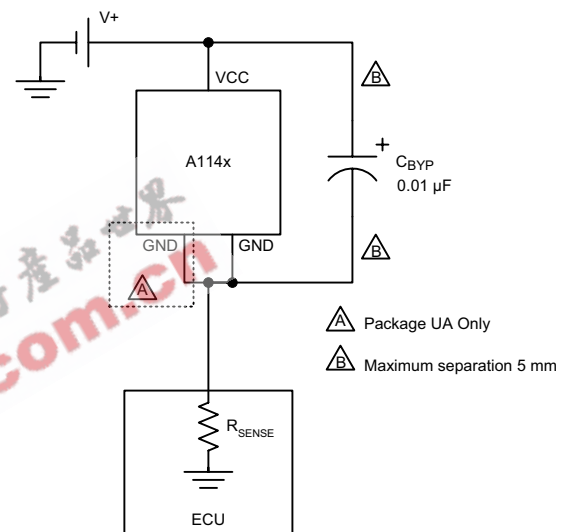

Figure 3. Typical application circuit

For additional general application information, visit the Allegro Web site at www.allegromicro.com.

A1147 and A1148

Low Current Ultrasensitive Two-Wire Chopper-Stabilized Unipolar Hall Effect Switches

Power Derating

The device must be operated below the maximum junction temperature of the device, $T_{J(\max)}$. Under certain combinations of peak conditions, reliable operation may require derating supplied power or improving the heat dissipation properties of the application. This section presents a procedure for correlating factors affecting operating T_J . (Thermal data is also available on the Allegro MicroSystems Web site.)

The Package Thermal Resistance, $R_{\theta JA}$, is a figure of merit summarizing the ability of the application and the device to dissipate heat from the junction (die), through all paths to the ambient air. Its primary component is the Effective Thermal Conductivity, K , of the printed circuit board, including adjacent devices and traces. Radiation from the die through the device case, $R_{\theta JC}$, is relatively small component of $R_{\theta JA}$. Ambient air temperature, T_A , and air motion are significant external factors, damped by overmolding.

The effect of varying power levels (Power Dissipation, P_D), can be estimated. The following formulas represent the fundamental relationships used to estimate T_J , at P_D .

$$P_D = V_{IN} \times I_{IN} \quad (1)$$

$$\Delta T = P_D \times R_{\theta JA} \quad (2)$$

$$T_J = T_A + \Delta T \quad (3)$$

For example, given common conditions such as: $T_A = 25^\circ\text{C}$, $V_{CC} = 12\text{ V}$, $I_{CC} = 4\text{ mA}$, and $R_{\theta JA} = 140\text{ }^\circ\text{C/W}$, then:

$$P_D = V_{CC} \times I_{CC} = 12\text{ V} \times 4\text{ mA} = 48\text{ mW}$$

$$\Delta T = P_D \times R_{\theta JA} = 48\text{ mW} \times 140\text{ }^\circ\text{C/W} = 7^\circ\text{C}$$

$$T_J = T_A + \Delta T = 25^\circ\text{C} + 7^\circ\text{C} = 32^\circ\text{C}$$

A worst-case estimate, $P_{D(\max)}$, represents the maximum allowable power level ($V_{CC(\max)}$, $I_{CC(\max)}$), without exceeding $T_{J(\max)}$, at a selected $R_{\theta JA}$ and T_A .

Example: Reliability for V_{CC} at $T_A = 150^\circ\text{C}$, package UA, using minimum-K PCB.

Observe the worst-case ratings for the device, specifically: $R_{\theta JA} = 165^\circ\text{C/W}$, $T_{J(\max)} = 165^\circ\text{C}$, $V_{CC(\max)} = 24\text{ V}$, and $I_{CC(\max)} = 17\text{ mA}$.

Calculate the maximum allowable power level, $P_{D(\max)}$. First, invert equation 3:

$$\Delta T_{\max} = T_{J(\max)} - T_A = 165^\circ\text{C} - 150^\circ\text{C} = 15^\circ\text{C}$$

This provides the allowable increase to T_J resulting from internal power dissipation. Then, invert equation 2:

$$P_{D(\max)} = \Delta T_{\max} \div R_{\theta JA} = 15^\circ\text{C} \div 165\text{ }^\circ\text{C/W} = 91\text{ mW}$$

Finally, invert equation 1 with respect to voltage:

$$V_{CC(\text{est})} = P_{D(\max)} \div I_{CC(\max)} = 91\text{ mW} \div 17\text{ mA} = 5\text{ V}$$

The result indicates that, at T_A , the application and device can dissipate adequate amounts of heat at voltages $\leq V_{CC(\text{est})}$.

Compare $V_{CC(\text{est})}$ to $V_{CC(\max)}$. If $V_{CC(\text{est})} \leq V_{CC(\max)}$, then reliable operation between $V_{CC(\text{est})}$ and $V_{CC(\max)}$ requires enhanced $R_{\theta JA}$. If $V_{CC(\text{est})} \geq V_{CC(\max)}$, then operation between $V_{CC(\text{est})}$ and $V_{CC(\max)}$ is reliable under these conditions.

A1147 and A1148

Low Current Ultrasensitive Two-Wire Chopper-Stabilized Unipolar Hall Effect Switches

Device Qualification Program

Contact Allegro for information.

EMC (Electromagnetic Compatibility) Requirements

Contact your local representative for EMC results.

Test Name	Reference Specification
ESD – Human Body Model	AEC-Q100-002
ESD – Machine Model	AEC-Q100-003
Conducted Transients	ISO 7637-1
Direct RF Injection	ISO 11452-7
Bulk Current Injection	ISO 11452-4
TEM Cell	ISO 11452-3

A1147 and A1148

Low Current Ultrasensitive Two-Wire Chopper-Stabilized Unipolar Hall Effect Switches

Product Selection Guide

Use the complete part numbers when ordering

Part Number	Pb-Free	Packing ^a	Package	Operating Ambient Temperature, T _A (°C)	Output Level in South (+) Field ^b
A1147ELHLT	–	Tape and Reel, 3000 pieces/reel	Surface Mount	–40 to 85	Low
A1147ELHLT-T	Yes				
A1147EUA	–	Bulk Bag, 500 pieces/bag	Through Hole		
A1147EUA-T	Yes				
A1147EUATI	–	Tape and Reel, 2000 pieces/reel			
A1147EUATI-T	Yes				
A1147LLHLT	–	Tape and Reel, 3000 pieces/reel	Surface Mount	–40 to 150	Low
A1147LLHLT-T	Yes				
A1147LUA	–	Bulk Bag, 500 pieces/bag	Through Hole		
A1147LUA-T	Yes				
A1147LUATI	–	Tape and Reel, 2000 pieces/reel			
A1147LUATI-T	Yes				
A1148ELHLT	–	Tape and Reel, 3000 pieces/reel	Surface Mount	–40 to 85	High
A1148ELHLT-T	Yes				
A1148EUA	–	Bulk Bag, 500 pieces/bag	Through Hole		
A1148EUA-T	Yes				
A1148EUATI	–	Tape and Reel, 2000 pieces/reel			
A1148EUATI-T	Yes				
A1148LLHLT	–	Tape and Reel, 3000 pieces/reel	Surface Mount	–40 to 150	High
A1148LLHLT-T	Yes				
A1148LUA	–	Bulk Bag, 500 pieces/bag	Through Hole		
A1148LUA-T	Yes				
A1148LUATI	–	Tape and Reel, 2000 pieces/reel			
A1148LUATI-T	Yes				

^aContact Allegro for additional packing options.

^bSouth (+) magnetic fields must be of sufficient strength.

A1147 and A1148

Low Current Ultrasensitive Two-Wire Chopper-Stabilized Unipolar Hall Effect Switches

Package LH, 3-Pin; (SOT-23W)

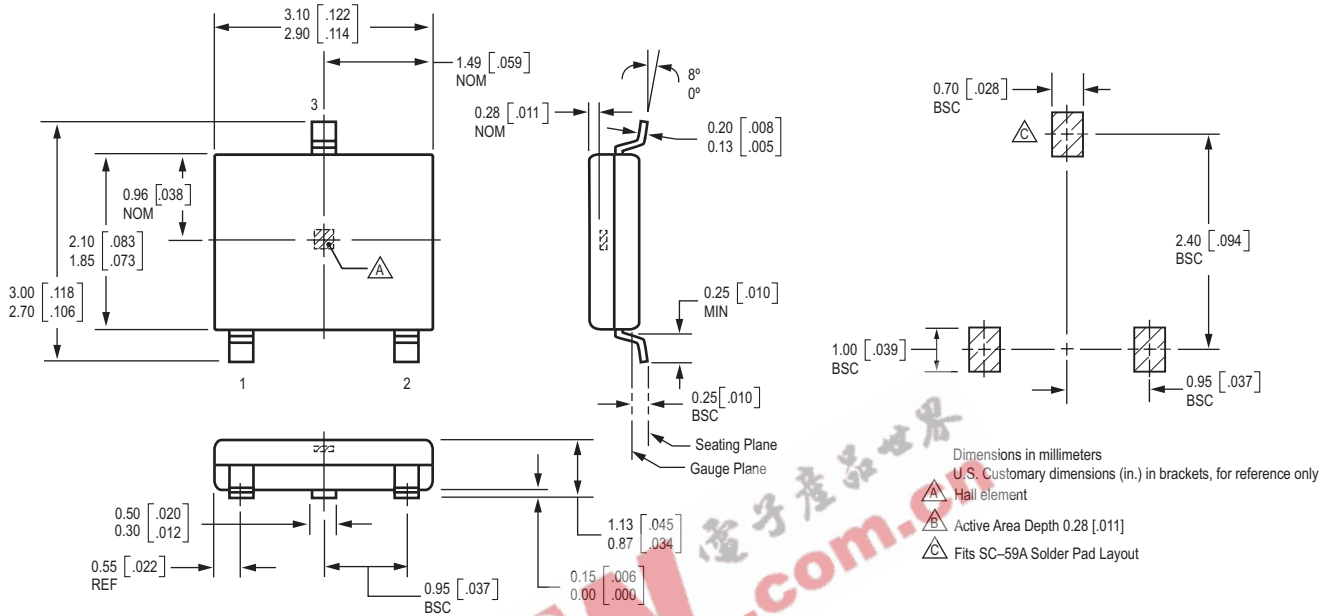

Package UA, 3-Pin SIP

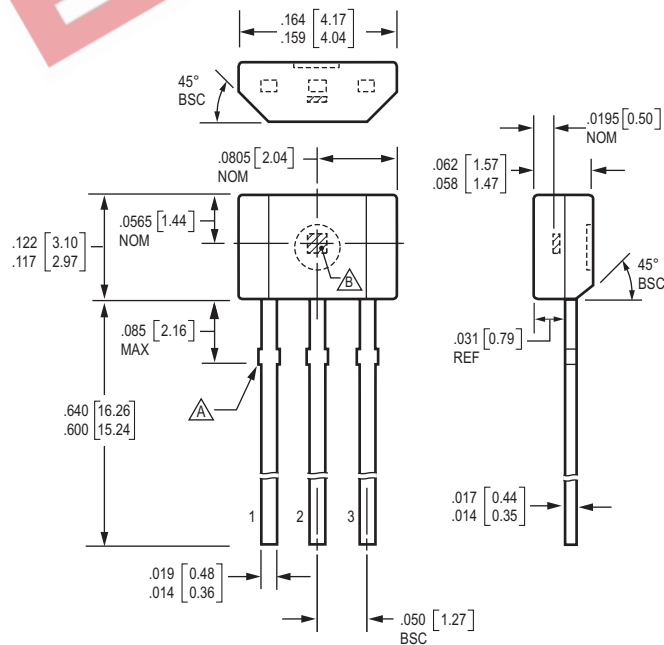

A1147 and A1148

Low Current Ultrasensitive Two-Wire Chopper-Stabilized Unipolar Hall Effect Switches

EEPW 电子产品世界
.com.cn

The products described herein are manufactured under one or more of the following U.S. patents: 5,045,920; 5,264,783; 5,442,283; 5,389,889; 5,581,179; 5,517,112; 5,619,137; 5,621,319; 5,650,719; 5,686,894; 5,694,038; 5,729,130; 5,917,320; and other patents pending.

Allegro MicroSystems, Inc. reserves the right to make, from time to time, such departures from the detail specifications as may be required to permit improvements in the performance, reliability, or manufacturability of its products. Before placing an order, the user is cautioned to verify that the information being relied upon is current.

Allegro products are not authorized for use as critical components in life-support devices or systems without express written approval.

The information included herein is believed to be accurate and reliable. However, Allegro MicroSystems, Inc. assumes no responsibility for its use; nor for any infringement of patents or other rights of third parties which may result from its use.

Copyright © 2004, 2005 Allegro MicroSystems, Inc.