



Low Cost, Low Noise, CMOS Rail-to-Rail Output Operational Amplifiers

AD8691/AD8692/AD8694

FEATURES

- Offset voltage: 400 μV typ
- Low offset voltage drift: 6 $\mu\text{V}/^\circ\text{C}$ max (AD8692/AD8694)
- Very low input bias currents: 1 pA max
- Low noise: 8 nV/ $\sqrt{\text{Hz}}$
- Low distortion: 0.0006%
- Wide bandwidth: 10 MHz
- Unity-gain stable
- Single-supply operation: 2.7 V to 6 V

APPLICATIONS

- Photodiode amplification
- Battery-powered instrumentation
- Medical instruments
- Multipole filters
- Sensors
- Portable audio devices

GENERAL DESCRIPTION

The AD8691, AD8692, and AD8694 are low cost, single, dual, and quad rail-to-rail output, single-supply amplifiers featuring low offset and input voltages, low current noise, and wide signal bandwidth. The combination of low offset, low noise, very low input bias currents, and high speed make these amplifiers useful in a wide variety of applications. Filters, integrators, photodiode amplifiers, and high impedance sensors all benefit from this combination of performance features. Audio and other ac applications benefit from the wide bandwidth and low distortion of these devices.

Rev. B

Information furnished by Analog Devices is believed to be accurate and reliable. However, no responsibility is assumed by Analog Devices for its use, nor for any infringements of patents or other rights of third parties that may result from its use. Specifications subject to change without notice. No license is granted by implication or otherwise under any patent or patent rights of Analog Devices. Trademarks and registered trademarks are the property of their respective owners.

PIN CONFIGURATIONS

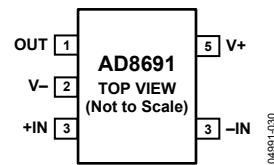

Figure 1. 5-Lead TSOT

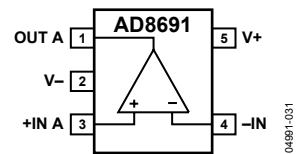

Figure 2. 5-Lead SC70

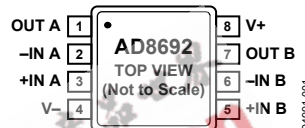

Figure 3. 8-Lead MSOP



Figure 4. 8-Lead SOIC

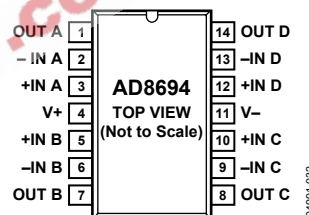

Figure 5. 14-Lead SOIC

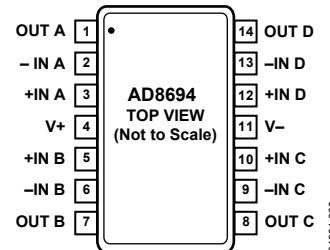

Figure 6. 14-Lead TSSOP

Applications for these amplifiers include PA controls, laser diode control loops, portable and loop-powered instrumentation, audio amplification for portable devices, and ASIC input and output amplifiers.

The small SC70 and TSOT package options for the AD8691 allow it to be placed next to sensors, thereby reducing external noise pickup.

The AD8691, AD8692, and AD8694 are specified over the extended industrial temperature range of -40°C to $+125^\circ\text{C}$. The AD8691 single is available in 5-lead SC70 and TSOT packages. The AD8692 dual is available in 8-lead MSOP and narrow SOIC surface-mount packages. The AD8694 quad is available in 14-lead TSSOP and narrow 14-lead SOIC packages.

AD8691/AD8692/AD8694

TABLE OF CONTENTS

Electrical Characteristics	3	Typical Performance Characteristics	6
Absolute Maximum Ratings.....	5	Outline Dimensions.....	11
Thermal Characteristics	5	Ordering Guide	12
ESD Caution.....	5		

REVISION HISTORY

3/05—Rev. A to Rev. B

Added AD8694 Universal

1/05—Rev. 0 to Rev. A

Added AD8691 Universal

Changes to Features..... 1

Added Figure 1 and Figure 2..... 1

Changes to Electrical Characteristics 3

Changes to Figure 6 caption..... 6

Changes to Figure 9..... 6

Updated Outline Dimensions..... 11

Changes to Ordering Guide 11

10/04—Revision 0: Initial Version



ELECTRICAL CHARACTERISTICS

$V_S = 2.7\text{ V}$, $V_{CM} = V_S/2$, $T_A = 25^\circ\text{C}$, unless otherwise noted.

Table 1.

Parameter	Symbol	Conditions	Min	Typ	Max	Unit
INPUT CHARACTERISTICS						
Offset Voltage	V_{OS}	$V_{CM} = -0.3\text{ V to }+1.6\text{ V}$ $V_{CM} = -0.1\text{ V to }+1.6\text{ V}; -40^\circ\text{C} < T_A < +125^\circ\text{C}$		0.4	2.0	mV
Input Bias Current	I_B	$-40^\circ\text{C} < T_A < +85^\circ\text{C}$ $-40^\circ\text{C} < T_A < +125^\circ\text{C}$		0.2	1	pA
Input Offset Current	I_{OS}	$-40^\circ\text{C} < T_A < +85^\circ\text{C}$ $-40^\circ\text{C} < T_A < +125^\circ\text{C}$		0.1	0.5	pA
Input Voltage Range			-0.3		+1.6	V
Common-Mode Rejection Ratio	CMRR	$V_{CM} = -0.3\text{ V to }+1.6\text{ V}$ $V_{CM} = -0.1\text{ V to }+1.6\text{ V}; -40^\circ\text{C} < T_A < +125^\circ\text{C}$	68	90		dB
Large Signal Voltage Gain	A_{VO}	$R_L = 2\text{ k}\Omega$, $V_O = 0.5\text{ V to }2.2\text{ V}$ $R_L = 2\text{ k}\Omega$, $V_O = 0.5\text{ V to }2.2\text{ V}$	60	85		dB
AD8694			90	250		V/mV
Offset Voltage Drift	$\Delta V_{OS}/\Delta T$					V/mV
AD8691			2	12		$\mu\text{V}/^\circ\text{C}$
AD8692/AD8694			1.3	6		$\mu\text{V}/^\circ\text{C}$
INPUT CAPACITANCE						
Common-Mode Input Capacitance	C_{CM}			5		pF
Differential Input Capacitance	C_{DM}			2.5		pF
OUTPUT CHARACTERISTICS						
Output Voltage High	V_{OH}	$I_L = 1\text{ mA}$ $-40^\circ\text{C} < T_A < +125^\circ\text{C}$	2.64	2.66		V
Output Voltage Low	V_{OL}	$I_L = 1\text{ mA}$ $-40^\circ\text{C} < T_A < +125^\circ\text{C}$	2.6			V
Short-Circuit Current	I_{SC}			25	40	mV
Closed-Loop Output Impedance	Z_{OUT}	$f = 1\text{ MHz}$, $A_V = 1$			60	mV
				± 20		mA
				12		Ω
POWER SUPPLY						
Power Supply Rejection Ratio	PSRR	$V_S = 2.7\text{ V to }5.5\text{ V}$ $-40^\circ\text{C} < T_A < +125^\circ\text{C}$	80	95		dB
Supply Current/Amplifier	I_{SY}	$V_O = 0\text{ V}$ $-40^\circ\text{C} < T_A < +125^\circ\text{C}$	75	95		dB
				0.85	0.95	mA
					1.2	mA
DYNAMIC PERFORMANCE						
Slew Rate	SR	$R_L = 2\text{ k}\Omega$		5		V/ μs
Settling Time	t_S	To 0.01%		1		μs
Gain Bandwidth Product	GBP			10		MHz
Phase Margin	ϕ_O			60		Degrees
Total Harmonic Distortion + Noise	THD + N	$G = 1$, $R_L = 600\ \Omega$, $f = 1\text{ kHz}$, $V_O = 250\text{ mV p-p}$		0.003		%
NOISE PERFORMANCE						
Voltage Noise	$e_{n\text{ p-p}}$	$f = 0.1\text{ Hz to }10\text{ Hz}$		1.6	3.0	$\mu\text{V p-p}$
Voltage Noise Density	e_n	$f = 1\text{ kHz}$		8	12	nV/ $\sqrt{\text{Hz}}$
	e_n	$f = 10\text{ kHz}$		6.5		nV/ $\sqrt{\text{Hz}}$
Current Noise Density	i_n	$f = 1\text{ kHz}$		0.05		pA/ $\sqrt{\text{Hz}}$

AD8691/AD8692/AD8694

$V_S = 5.0\text{ V}$, $V_{CM} = V_S/2$, $T_A = 5^\circ\text{C}$, unless otherwise noted.

Table 2.

Parameter	Symbol	Conditions	A Grade			Unit	
			Min	Typ	Max		
INPUT CHARACTERISTICS							
Offset Voltage	V_{OS}	$V_{CM} = -0.3\text{ V to }+3.9\text{ V}$ $V_{CM} = -0.1\text{ V to }+3.9\text{ V}; -40^\circ\text{C} < T_A < +125^\circ\text{C}$		0.4	2.0	mV	
Input Bias Current	I_B	$-40^\circ\text{C} < T_A < +85^\circ\text{C}$ $-40^\circ\text{C} < T_A < +125^\circ\text{C}$		0.2	1	pA	
					50	260	pA
Input Offset Current	I_{OS}	$-40^\circ\text{C} < T_A < +85^\circ\text{C}$ $-40^\circ\text{C} < T_A < +125^\circ\text{C}$		0.1	0.5	pA	
					20	75	pA
Input Voltage Range			-0.3		+3.9	V	
Common-Mode Rejection Ratio	CMRR	$V_{CM} = -0.3\text{ V to }+3.9\text{ V}$ $V_{CM} = -0.1\text{ V to }+3.9\text{ V}; -40^\circ\text{C} < T_A < +125^\circ\text{C}$	70	95		dB	
			67	95		dB	
Large Signal Voltage Gain	A_{VO}	$V_O = 0.5\text{ V to }4.5\text{ V}$, $R_L = 2\text{ k}\Omega$, $V_{CM} = 0\text{ V}$ $V_O = 0.5\text{ V to }4.5\text{ V}$, $R_L = 2\text{ k}\Omega$, $V_{CM} = 0\text{ V}$	250	2000		V/mV	
			150			V/mV	
Offset Voltage Drift	$\Delta V_{OS}/\Delta T$			2	12	$\mu\text{V}/^\circ\text{C}$	
				1.3	6	$\mu\text{V}/^\circ\text{C}$	
INPUT CAPACITANCE							
Common-Mode Input Capacitance	C_{CM}			5		pF	
Differential Input Capacitance	C_{DM}			2.5		pF	
OUTPUT CHARACTERISTICS							
Output Voltage High	V_{OH}	$I_L = 1\text{ mA}$ $I_L = 10\text{ mA}$ $-40^\circ\text{C to }+125^\circ\text{C}$	4.96	4.98		V	
			4.7	4.78		V	
			4.6			V	
Voltage Low	V_{OL}	$I_L = 1\text{ mA}$ $I_L = 10\text{ mA}$ $I_L = 10\text{ mA}$ $-40^\circ\text{C to }+125^\circ\text{C}$ $-40^\circ\text{C to }+125^\circ\text{C}$		20	40	mV	
					165	210	mV
					185	240	mV
						290	mV
						370	mV
Short-Circuit Current	I_{SC}			± 80		mA	
Closed-Loop Output Impedance	Z_{OUT}	$f = 1\text{ MHz}$, $A_V = 1$		10		Ω	
POWER SUPPLY							
Power Supply Rejection Ratio	PSRR	$V_S = 2.7\text{ V to }5.5\text{ V}$ $-40^\circ\text{C} < T_A < +125^\circ\text{C}$	80	95		dB	
			75	95		dB	
Supply Current/Amplifier	I_{SY}	$V_O = 0\text{ V}$ $-40^\circ\text{C} < T_A < +125^\circ\text{C}$		0.95	1.05	mA	
					1.3	mA	
DYNAMIC PERFORMANCE							
Slew Rate	SR	$R_L = 2\text{ k}\Omega$		5		V/ μs	
Settling Time	t_s	To 0.01%		1		μs	
Full Power Bandwidth	BW_P	<1% distortion		360		kHz	
Gain Bandwidth Product	GBP			10		MHz	
Phase Margin	ϕ_O			65		Degrees	
Total Harmonic Distortion + Noise	THD + N	$G = 1$, $R_L = 600\ \Omega$, $f = 1\text{ kHz}$, $V_O = 1\text{ V p-p}$		0.0006		%	
NOISE PERFORMANCE							
Voltage Noise	$e_{n\text{ p-p}}$	$f = 0.1\text{ Hz to }10\text{ Hz}$		1.6	3.0	$\mu\text{V p-p}$	
Voltage Noise Density	e_n	$f = 1\text{ kHz}$ $f = 10\text{ kHz}$		8	12	nV/ $\sqrt{\text{Hz}}$	
				6.5		nV/ $\sqrt{\text{Hz}}$	
Current Noise Density	i_n	$f = 1\text{ kHz}$		0.05		pA/ $\sqrt{\text{Hz}}$	

ABSOLUTE MAXIMUM RATINGS

$T_A = 25^\circ\text{C}$, unless otherwise noted.

Table 3.

Parameters	Ratings
Supply Voltage	6 V
Input Voltage	$V_{SS} - 0.3\text{ V}$ to $V_{DD} + 0.3\text{ V}$
Differential Input Voltage	$\pm 6\text{ V}$
Output Short-Circuit Duration to GND	Observe derating curves
Storage Temperature Range	-65°C to $+150^\circ\text{C}$
Operating Temperature Range	-40°C to $+125^\circ\text{C}$
Junction Temperature Range	-65°C to $+150^\circ\text{C}$
Lead Temperature Range (Soldering, 60 sec)	300°C

Stresses above those listed under Absolute Maximum Ratings may cause permanent damage to the device. This is a stress rating only; functional operation of the device at these or any other conditions above those indicated in the operational section of this specification is not implied. Exposure to absolute maximum rating conditions for extended periods may affect device reliability.

THERMAL CHARACTERISTICS

Table 4.

Package Type	θ_{JA}^1	θ_{JC}	Unit
8-Lead MSOP (RM)	210	45	$^\circ\text{C}/\text{W}$
8-Lead SOIC (R)	158	43	$^\circ\text{C}/\text{W}$
5-Lead TSOT (UJ-5)	207	61	$^\circ\text{C}/\text{W}$
5-Lead SC70 (KS)	376	126	$^\circ\text{C}/\text{W}$
14-Lead TSSOP (RU)	180	35	$^\circ\text{C}/\text{W}$
14-Lead SOIC (R)	120	36	$^\circ\text{C}/\text{W}$

¹ θ_{JA} is specified for the worst-case conditions, that is, the device soldered in the circuit board for surface-mount packages.

ESD CAUTION

ESD (electrostatic discharge) sensitive device. Electrostatic charges as high as 4000 V readily accumulate on the human body and test equipment and can discharge without detection. Although this product features proprietary ESD protection circuitry, permanent damage may occur on devices subjected to high energy electrostatic discharges. Therefore, proper ESD precautions are recommended to avoid performance degradation or loss of functionality.



AD8691/AD8692/AD8694

TYPICAL PERFORMANCE CHARACTERISTICS

$V_S = +5\text{ V}$ or $\pm 2.5\text{ V}$, unless otherwise noted.

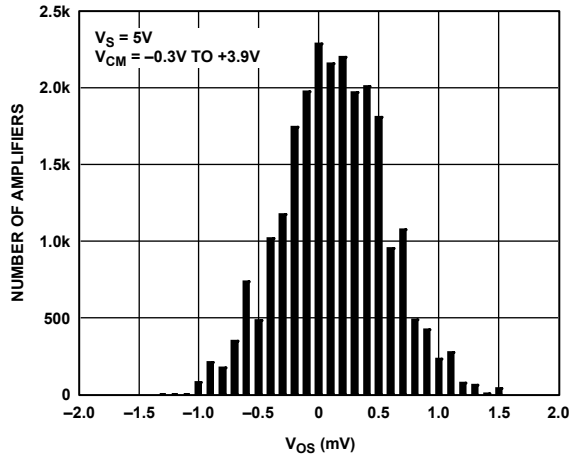

Figure 7. Input Offset Voltage Distribution

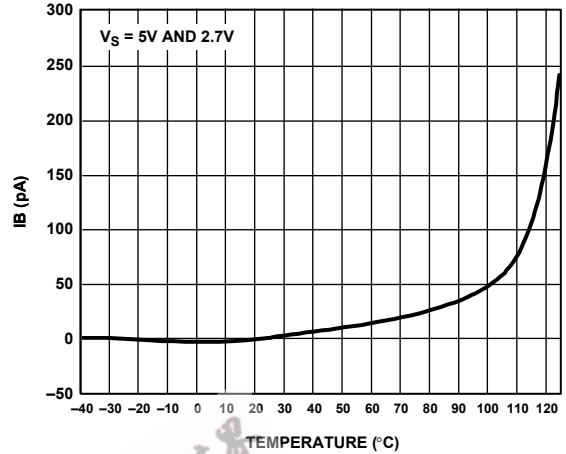

Figure 10. Input Bias Current vs. Temperature

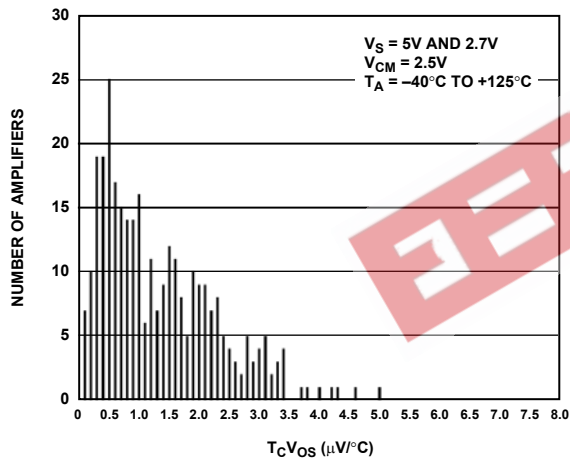

Figure 8. AD8692/AD8694 Input Offset Voltage Drift Distribution

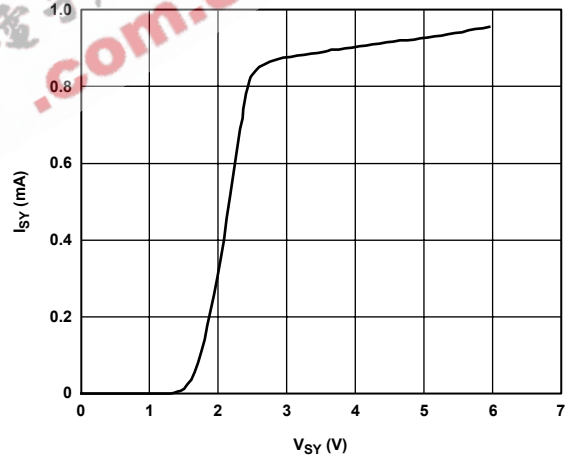

Figure 11. Supply Current vs. Supply Voltage

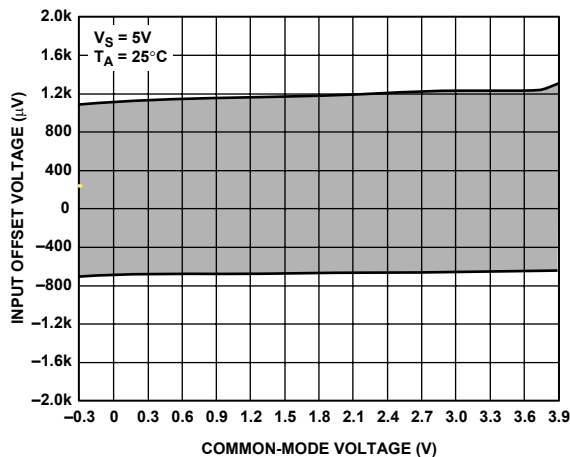

Figure 9. Input Offset Voltage vs. Common-Mode Voltage

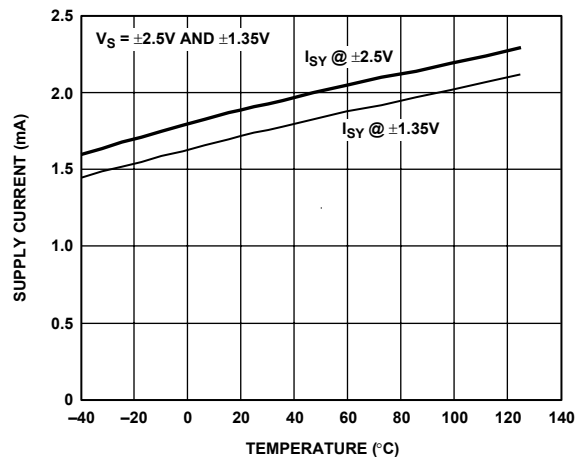

Figure 12. Supply Current vs. Temperature

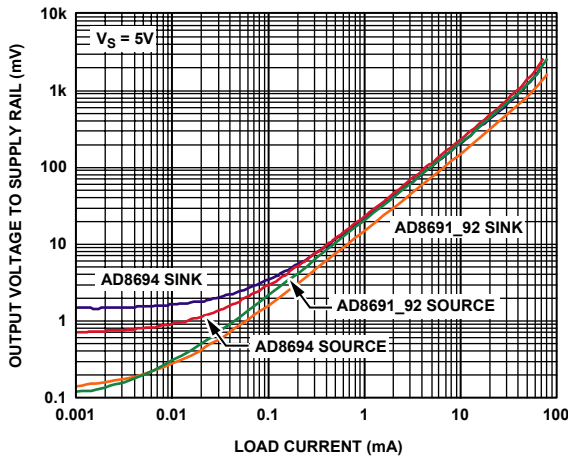

Figure 13. Output Voltage to Supply Rail vs. Load Current

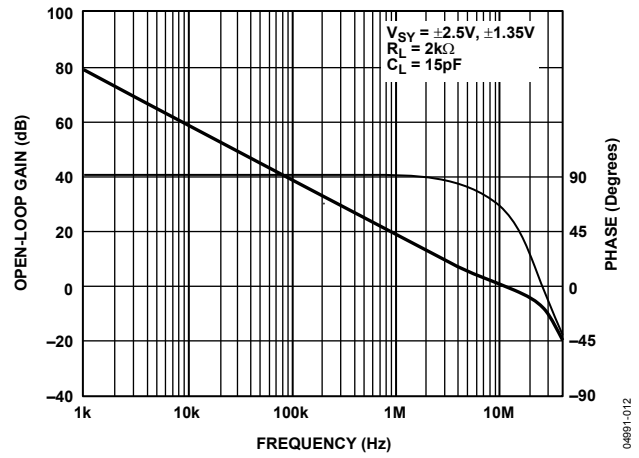

Figure 16. Open-Loop Gain and Phase vs. Frequency

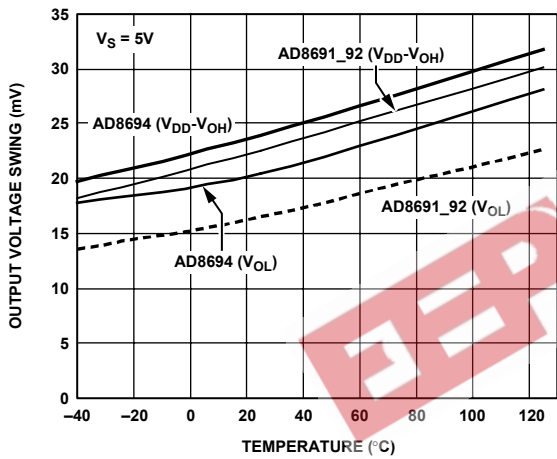

Figure 14. Output Voltage Swing vs. Temperature ($I_L = 1 \text{ mA}$)

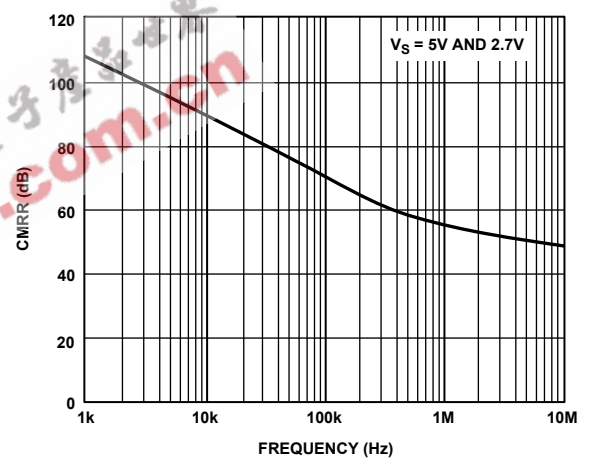

Figure 17. CMRR vs. Frequency

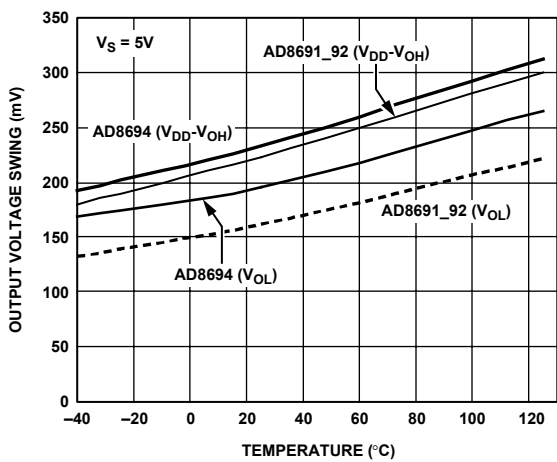

Figure 15. Output Voltage Swing vs. Temperature ($I_L = 10 \text{ mA}$)

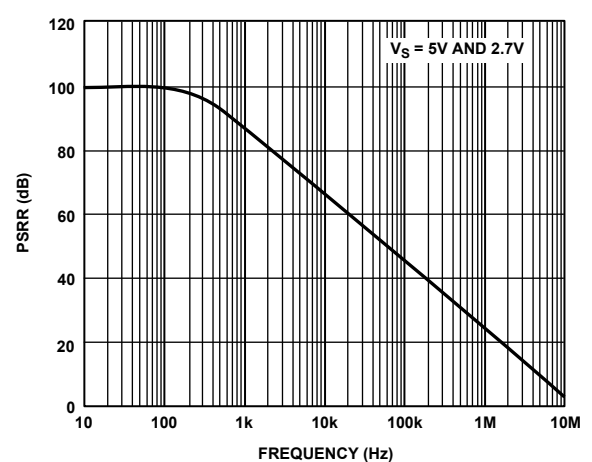

Figure 18. PSRR vs. Frequency

AD8691/AD8692/AD8694

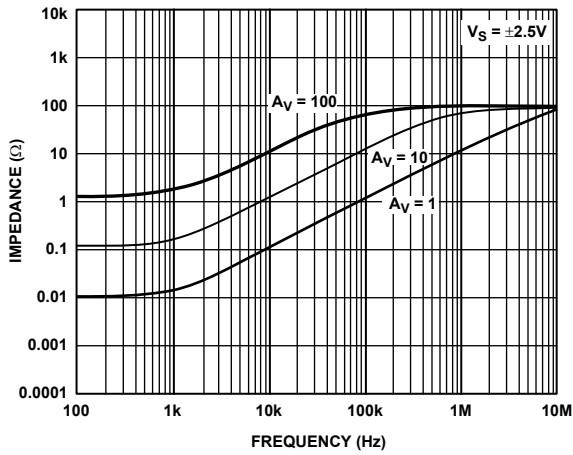

Figure 19. Closed-Loop Output Impedance vs. Frequency

04991-015

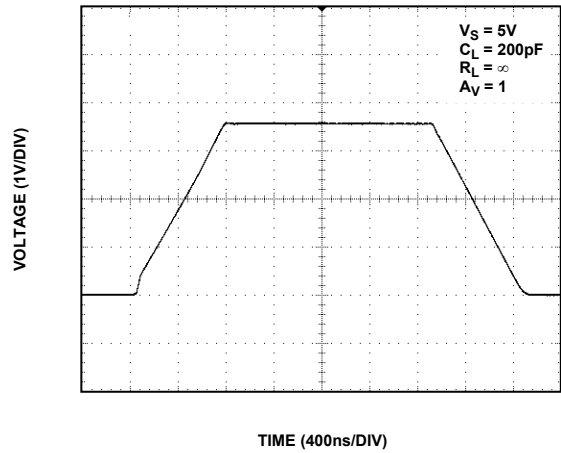

Figure 22. Large Signal Transient Response

04991-018

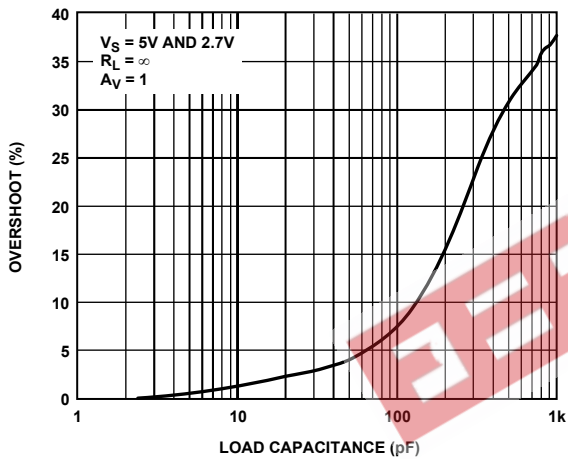

Figure 20. Small Signal Overshoot vs. Load Capacitance

04991-016

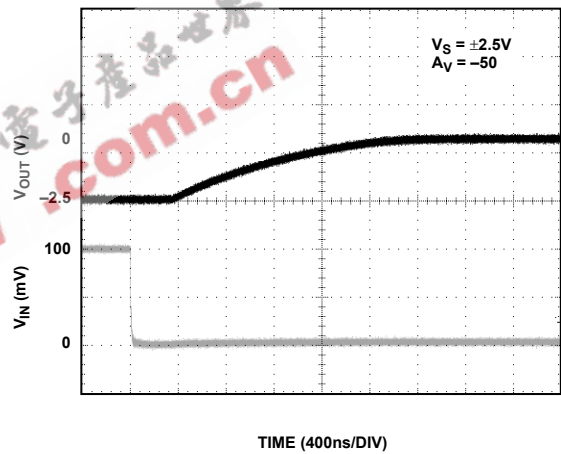

Figure 23. Positive Overload Recovery

04991-019

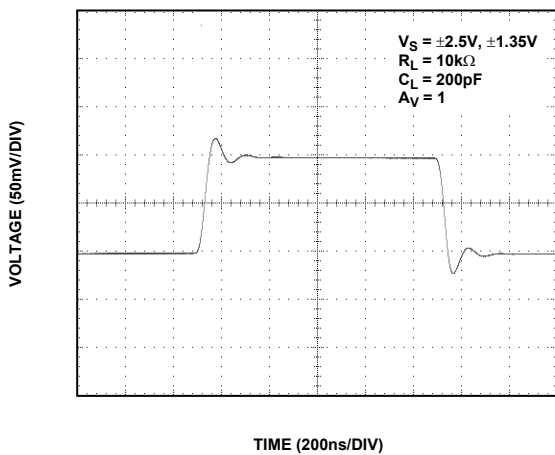

Figure 21. Small Signal Transient Response

04991-017

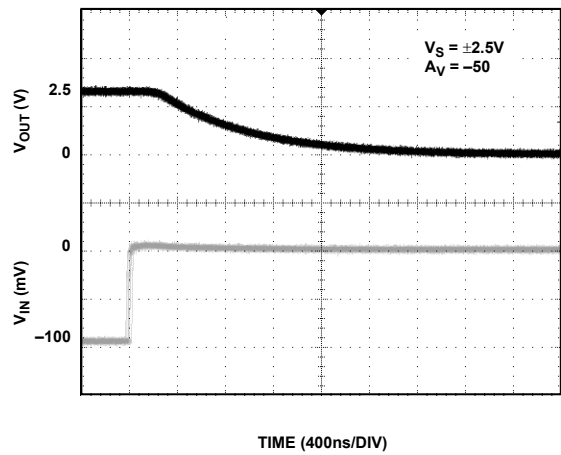

Figure 24. Negative Overload Recovery

04991-020

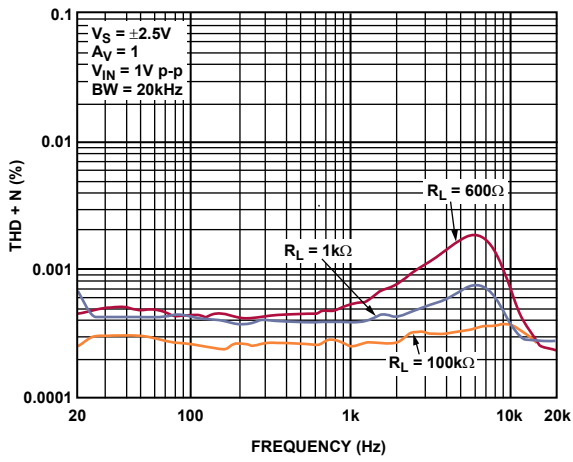

Figure 25. THD + N vs. Frequency

04891-021

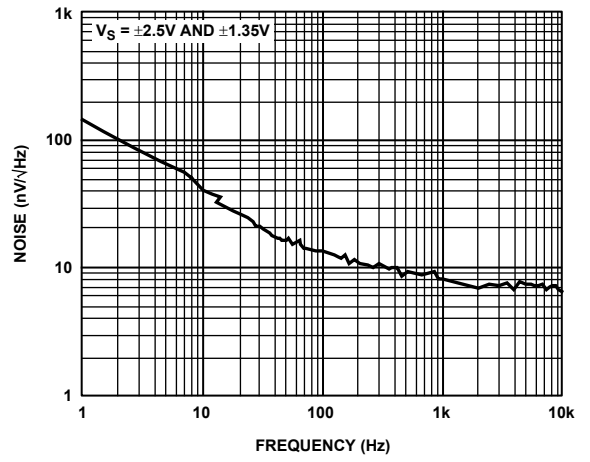

Figure 27. Voltage Noise Density

04891-023

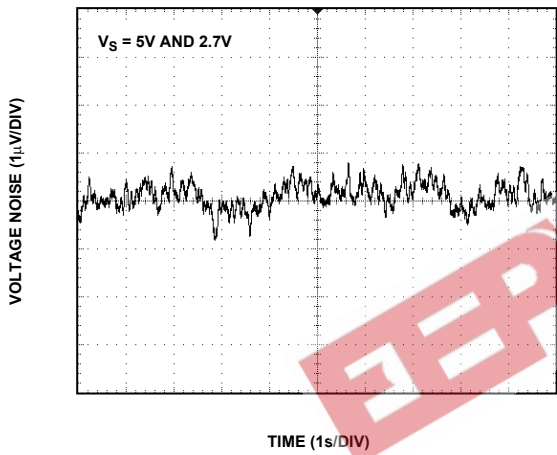

Figure 26. 0.1 Hz to 10 Hz Input Voltage Noise

04891-022

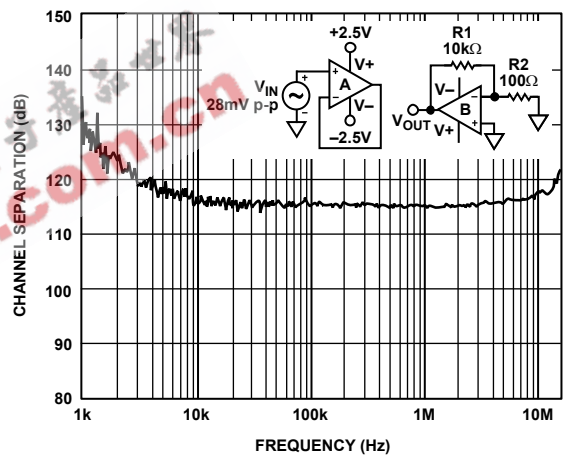

Figure 28. AD8692/AD8694 Channel Separation

04891-024

AD8691/AD8692/AD8694

$V_S = +2.7\text{ V}$ or $\pm 1.35\text{ V}$, unless otherwise noted.

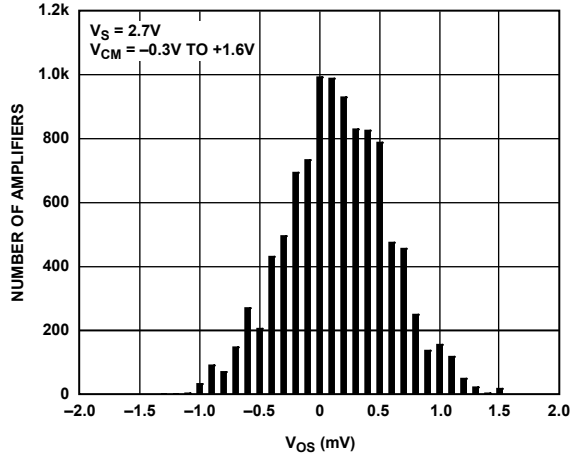

Figure 29. Input Offset Voltage Distribution

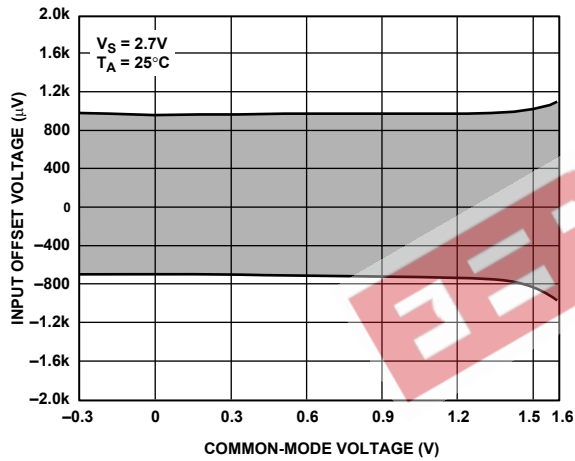

Figure 30. Input Offset Voltage vs. Common-Mode Voltage

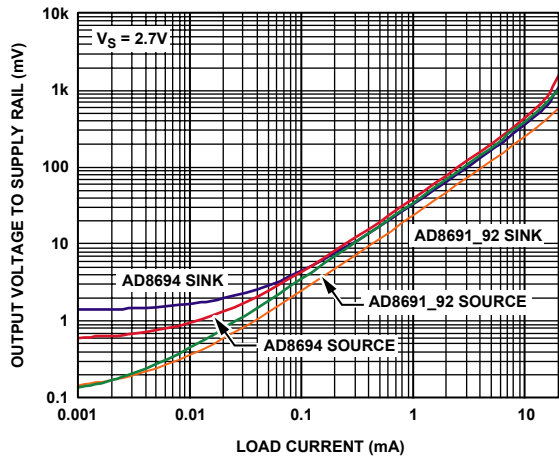

Figure 31. Output Voltage to Supply Rail vs. Load Current

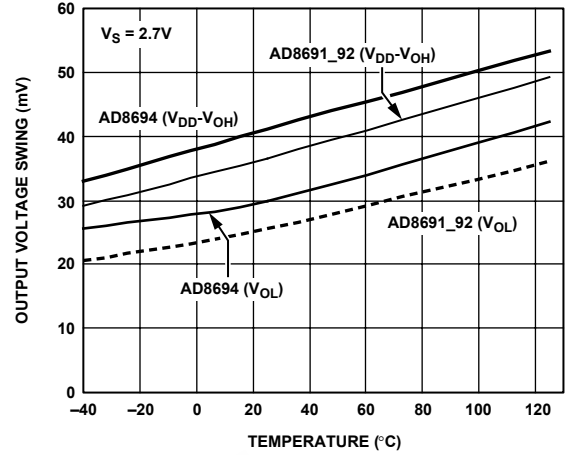

Figure 32. Output Voltage Swing vs. Temperature ($I_L = 1\text{ mA}$)

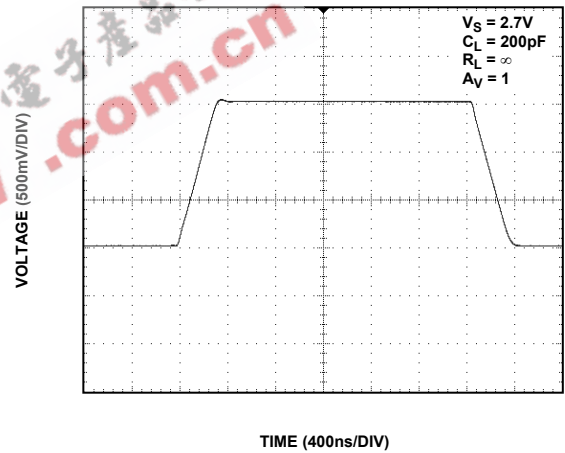

Figure 33. Large Signal Transient Response

04991-025

04991-028

04991-026

04991-029

04991-027

OUTLINE DIMENSIONS

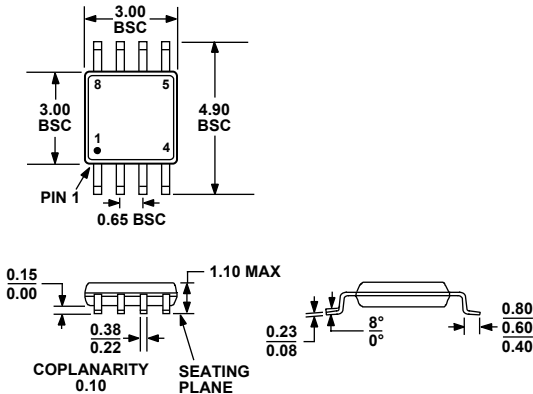

COMPLIANT TO JEDEC STANDARDS MO-187-AA

Figure 34. 8-Lead Mini Small Outline Package [MSOP] (RM-8)

Dimensions shown in millimeters

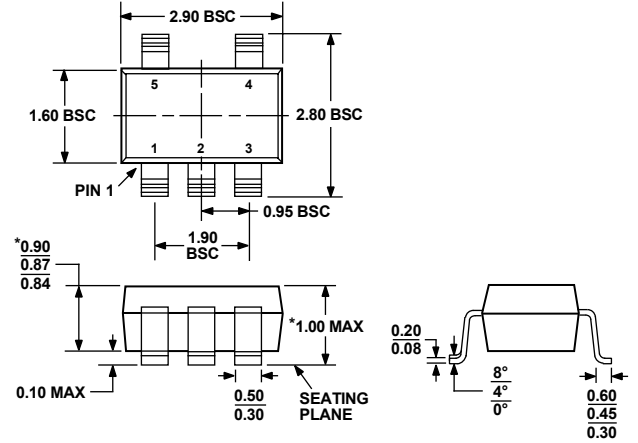

*COMPLIANT TO JEDEC STANDARDS MO-193-AB WITH THE EXCEPTION OF PACKAGE HEIGHT AND THICKNESS.

Figure 37. 5-Lead Thin Small Outline Transistor Package [TSOT] (UJ-5)

Dimensions shown in millimeters

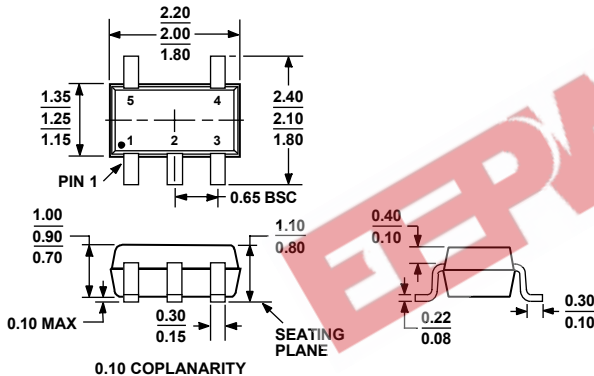

COMPLIANT TO JEDEC STANDARDS MO-203AA

Figure 35. 5-Lead Thin Shrink Small Outline Package [SC70] (KS-5)

Dimensions shown in millimeters

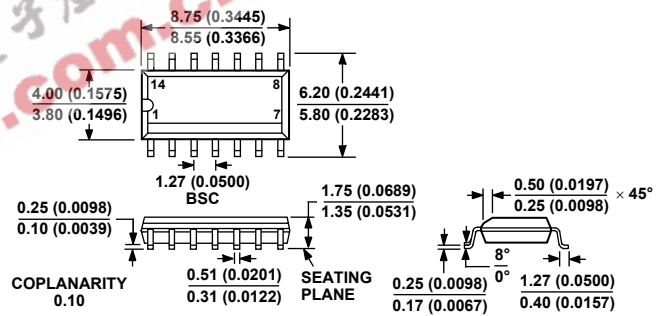

COMPLIANT TO JEDEC STANDARDS MS-012-AB CONTROLLING DIMENSIONS ARE IN MILLIMETERS; INCH DIMENSIONS (IN PARENTHESES) ARE ROUNDED-OFF MILLIMETER EQUIVALENTS FOR REFERENCE ONLY AND ARE NOT APPROPRIATE FOR USE IN DESIGN

Figure 38. 14-Lead Standard Small Outline Package [SOIC] Narrow Body (R-14)

Dimensions shown in millimeters

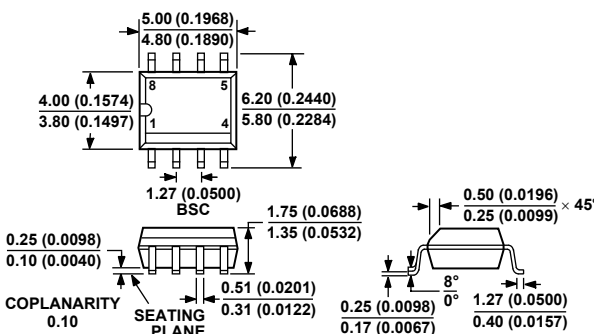

COMPLIANT TO JEDEC STANDARDS MS-012-AA

CONTROLLING DIMENSIONS ARE IN MILLIMETERS; INCH DIMENSIONS (IN PARENTHESES) ARE ROUNDED-OFF MILLIMETER EQUIVALENTS FOR REFERENCE ONLY AND ARE NOT APPROPRIATE FOR USE IN DESIGN

Figure 36. 8-Lead Standard Small Outline Package [SOIC] Narrow Body (R-8)

Dimensions shown in millimeters and (inches)

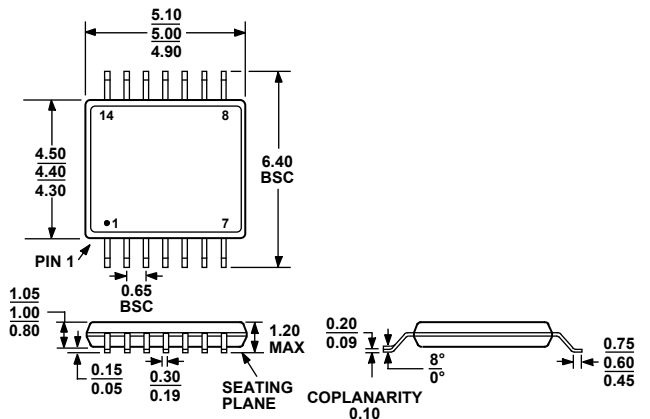

COMPLIANT TO JEDEC STANDARDS MO-153AB-1

Figure 39. 14-Lead Thin Shrink Small Outline Package [TSSOP] (RU-14)

Dimensions shown in millimeters

AD8691/AD8692/AD8694

ORDERING GUIDE

Model	Temperature Range	Package Description	Package Option	Branding
AD8691AUJZ-R2	-40°C to +125°C	5-Lead TSOT	UJ-5	ACA
AD8691AUJZ-REEL	-40°C to +125°C	5-Lead TSOT	UJ-5	ACA
AD8691AUJZ-REEL7	-40°C to +125°C	5-Lead TSOT	UJ-5	ACA
AD8691AKSZ-R2	-40°C to +125°C	5-Lead SC70	KS-5	ACA
AD8691AKSZ-REEL	-40°C to +125°C	5-Lead SC70	KS-5	ACA
AD8691AKSZ-REEL7	-40°C to +125°C	5-Lead SC70	KS-5	ACA
AD8692ARMZ-R2 ¹	-40°C to +125°C	8-Lead MSOP	RM-8	APA
AD8692ARMZ-REEL	-40°C to +125°C	8-Lead MSOP	RM-8	APA
AD8692ARZ	-40°C to +125°C	8-Lead SOIC	R-8	
AD8692ARZ-REEL	-40°C to +125°C	8-Lead SOIC	R-8	
AD8692ARZ-REEL7	-40°C to +125°C	8-Lead SOIC	R-8	
AD8694ARUZ	-40°C to +125°C	14-Lead TSSOP	RU-14	
AD8694ARUZ-REEL	-40°C to +125°C	14-Lead TSSOP	RU-14	
AD8694ARZ	-40°C to +125°C	14-Lead SOIC	R-14	
AD8694ARZ-REEL	-40°C to +125°C	14-Lead SOIC	R-14	
AD8694ARZ-REEL7	-40°C to +125°C	14-Lead SOIC	R-14	

¹ Z = Pb-free part.