



# High Accuracy Data Acquisition Instrumentation Amplifier

## FEATURES

### Performance

- Low Drift:  $2.0\mu\text{V}/^\circ\text{C}$  (AD522B)
- Low Nonlinearity: 0.005% (G = 100)
- High CMRR:  $>110\text{dB}$  (G = 1000)
- Low Noise:  $1.5\mu\text{V}$  p-p (0.1 to 100Hz)
- Low Initial  $V_{OS}$ :  $100\mu\text{V}$  (AD522B)

### Versatility

- Single-Resistor Gain Programmable:  $1 \leq G \leq 1000$
- Output Reference and Sense Terminals
- Data Guard for Improving ac CMR

### Value

- Internally Compensated
- No External Components except Gain Resistor
- Active Trimmed Offset, Gain, and CMR

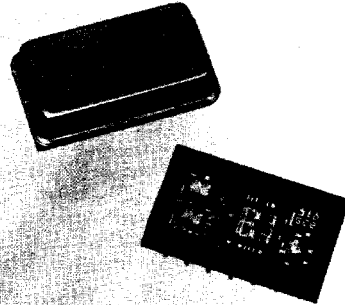

## PRODUCT DESCRIPTION

The AD522 is a precision IC instrumentation amplifier designed for data acquisition applications requiring high accuracy under worst-case operating conditions. An outstanding combination of high linearity, high common mode rejection, low voltage drift, and low noise makes the AD522 suitable for use in many 12-bit data acquisition systems.

An instrumentation amplifier is usually employed as a bridge amplifier for resistance transducers (thermistors, strain gauges, etc.) found in process control, instrumentation, data processing, and medical testing. The operating environment is frequently characterized by low signal-to-noise levels, fluctuating temperatures, unbalanced input impedances, and remote location which hinders recalibration.

The AD522 was designed to provide highly accurate signal conditioning under these severe conditions. It provides output offset voltage drift of less than  $10\mu\text{V}/^\circ\text{C}$ , input offset voltage drift of less than  $2.0\mu\text{V}/^\circ\text{C}$ , CMR above 80dB at unity gain (110dB at G = 1000), maximum gain nonlinearity of 0.001% at G = 1, and typical input impedance of  $10^9\Omega$ .

This excellent performance is achieved by combining a proven circuit configuration with state-of-the-art manufacturing technology which utilizes active laser trimming of tight-tolerance thin-film resistors to achieve low cost, small size and high reliability. This combination of high value with no-compromise performance gives the AD522 the best features of both monolithic and modular instrumentation amplifiers, thus providing extremely cost-effective precision low-level amplification.

The AD522 is available in three versions with differing accuracies and operating temperature ranges; the "A", and "B" are specified from  $-25^\circ\text{C}$  to  $+85^\circ\text{C}$ , and the "S" is guaran-

teed over the military/aerospace temperature range of  $-55^\circ\text{C}$  to  $+125^\circ\text{C}$ . All versions are packaged in a 14-pin DIP and are supplied in a pin configuration similar to that of the popular AD521 instrumentation amplifier.

## OUTLINE DIMENSIONS

Dimensions shown in inches and (mm).

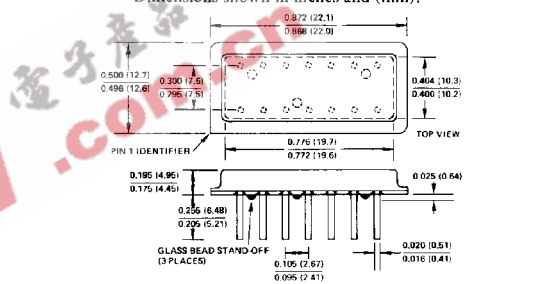

14-Pin Dual-In-Line Metal Package

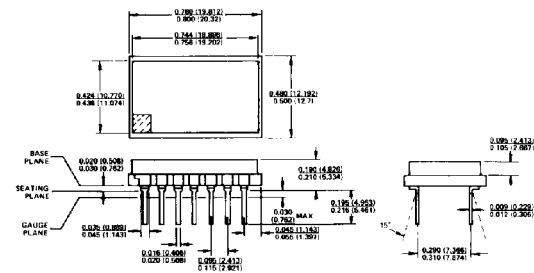

14-Pin Dual-In-Line Ceramic Package

Information furnished by Analog Devices is believed to be accurate and reliable. However, no responsibility is assumed by Analog Devices for its use, nor for any infringements of patents or other rights of third parties which may result from its use. No license is granted by implication or otherwise under any patent or patent rights of Analog Devices.

P.O. Box 280, Norwood, Massachusetts 02062 U.S.A.  
 Tel: 617/329-4700 Twx: 710/394-6577  
 Telex: 924491 Cables: ANALOG NORWOODMASS

# SPECIFICATIONS<sup>1</sup> (typical @ +V<sub>S</sub> = ±15V, R<sub>L</sub> = 2kΩ & T<sub>A</sub> = +25°C unless otherwise specified)

MODEL	AD522AD	AD522BD	AD522SD(SD/883B) <sup>2</sup>
<b>GAIN</b>			
Gain Equation	$1 + \frac{2(10^5)}{R_g}$	•	•
Gain Range	1 to 1000	•	•
Equation Error			
G = 1	0.2% max	0.05% max	**
G = 1000	1.0% max	0.2% max	**
Nonlinearity, max (see Fig. 4)			
G = 1	0.005%	0.001%	**
G = 1000	0.01%	0.005%	**
vs. Temp, max			
G = 1	2ppm/°C (1ppm/°C typ)	•	•
G = 1000	50ppm/°C (25ppm/°C typ)	•	•
<b>OUTPUT CHARACTERISTICS</b>			
Output Rating	±10V @ 5mA	•	•
<b>DYNAMIC RESPONSE (see Fig. 6)</b>			
Small Signal (-3dB)			
G = 1	300kHz	•	•
G = 100	3kHz	•	•
G = 1000	1.5kHz	•	•
Full Power GBW	1.5kHz	•	•
Slew Rate	0.1V/μs	•	•
Settling Time to 0.1%, G = 100	0.5ms	•	•
to 0.01%, G = 100	5ms	•	•
to 0.01%, G = 10	2ms	•	•
to 0.01%, G = 1	0.5ms	•	•
<b>VOLTAGE OFFSET</b>			
Offsets Referred to Input			
Initial Offset Voltage (adjustable to zero)			
G = 1	±400μV max (±200μV typ)	±200μV max (±100μV typ)	±200μV max (±100μV typ)
vs. Temperature, max (see Fig. 3)			
G = 1	±50μV/°C (±10μV/°C typ)	±25μV/°C (±5μV/°C typ)	±100μV/°C (±10μV/°C typ)
G = 1000	±6μV/°C	±2μV/°C	±6μV/°C
1 < G < 1000	±( $\frac{50}{G} + 6$ )μV/°C	±( $\frac{25}{G} + 2$ )μV/°C	±( $\frac{100}{G} + 6$ )μV/°C
vs. Supply, max			
G = 1	±20μV/%	•	•
G = 1000	±0.2μV/%	•	•
<b>INPUT CURRENTS</b>			
Input Bias Current			
Initial max, +25°C	±25nA	•	•
vs. Temperature	±100pA/°C	•	•
Input Offset Current			
Initial max, +25°C	±20nA	•	•
vs. Temperature	±100pA/°C	•	•
<b>INPUT</b>			
Input Impedance			
Differential	10 <sup>9</sup> Ω	•	•
Common Mode	10 <sup>9</sup> Ω	•	•
Input Voltage Range			
Maximum Differential Input, Linear	±10V	•	•
Maximum Differential Input, Safe	±20V	•	•
Maximum Common Mode, Linear	±10V	•	•
Maximum Common Mode Input, Safe	±15V	•	•
Common Mode Rejection Ratio, Min @ ±10V, 1kΩ Source			
Imbalance (see Fig. 5)			
G = 1 (dc to 30Hz)	75dB (90dB typ)	80dB (100dB typ)	75dB (90dB typ)
G = 10 (dc to 10Hz)	90dB (100dB typ)	95dB (110dB typ)	90dB (110dB typ)
G = 100 (dc to 3Hz)	100dB (110dB typ)	100dB (120dB typ)	100dB (120dB typ)
G = 1000 (dc to 1Hz)	100dB (120dB typ)	110dB (>120dB typ)	100dB (>120dB typ)
G = 1 to 1000 (dc to 60Hz)	75dB (88dB typ)	80dB (88dB typ)	•
<b>NOISE</b>			
Voltage Noise, RTI (see Fig. 4)			
0.1Hz to 100Hz (p-p)			
G = 1	15μV	•	•
G = 1000	1.5μV	•	•
10Hz to 10kHz (rms)			
G = 1	15μV	•	•
<b>TEMPERATURE RANGE</b>			
Specified Performance	-25°C to +85°C	•	-55°C to +125°C
Operating	-55°C to +125°C	•	•
Storage	-65°C to +150°C	•	•
<b>POWER SUPPLY</b>			
Power Supply Range			
Quiescent Current, max @ ±15V	±(5 to 18)V	•	•
	±10mA	±8mA	**
<b>PACKAGE</b>			
	Ceramic <sup>3</sup>	Ceramic <sup>3</sup>	Metal

## NOTES

<sup>1</sup> Specifications guaranteed after 10 minute warm-up.  
<sup>2</sup> The AD522SD is available processed to MIL-STD-883, Level B.  
<sup>3</sup> Analog Devices reserves the right to ship metal packages in lieu of the standard ceramic packages for A and B grades.

\* Specifications same as AD522A.  
 \*\* Specifications same as AD522B.  
 Specifications subject to change without notice.

**GENERAL APPLICATION CONSIDERATIONS**

Figure 1 illustrates the AD522 wiring configuration when used in a typical bridge amplifier application. In any low-level, high impedance, noise-dominated environment, proper shielding and grounding are requisite for optimum performance; a recommended technique is shown.

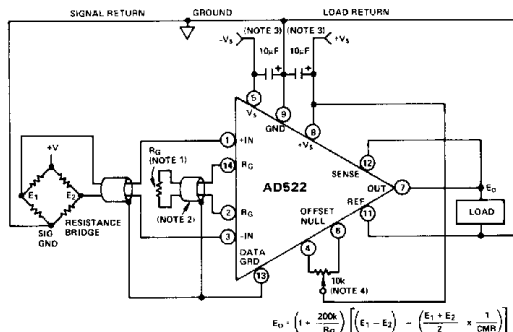

- NOTES:  
 1. GAIN RESISTOR  $R_G$  SHOULD BE  $\leq 500\Omega$  (VISHAY TYPE RECOMMENDED).  
 2. SHIELDED CONNECTIONS TO  $R_G$  RECOMMENDED WHEN MAXIMUM SYSTEM BANDWIDTH AND AC CMR IS REQUIRED, AND WHEN  $R_G$  IS LOCATED MORE THAN SIX INCHES FROM AD522. NO INSTABILITIES ARE CAUSED BY REMOTE  $R_G$  LOCATIONS, WHEN NOT USED, THE DATA GUARD PIN CAN BE LEFT UNCONNECTED.  
 3. POWER SUPPLY FILTERS ARE RECOMMENDED FOR MINIMUM NOISE IN NOISY ENVIRONMENTS.  
 4. NO TRIM REQUIRED FOR MOST APPLICATIONS. IF REQUIRED, A  $10k\Omega$ ,  $25ppm/^\circ C$ , 25 TURN TRIM POT (SUCH AS VISHAY 1202-Y-10K) IS RECOMMENDED.

Figure 1. Typical Bridge Application

Direct coupling of the AD522 inputs makes it necessary to provide a signal ground return for input amplifier bias currents. This can be achieved by direct connection as shown, or through an indirect path of less than  $1M\Omega$  resistance such as other system interconnections.

To minimize noise, shielding should be provided for the input leads and gain resistor connections. A passive data guard is provided to improve ac common mode rejection by "bootstrapping" the capacitance of the input cabling, thus minimizing differential phase shift. This will also reduce degradation of system bandwidth.

Balanced design eliminates the need for external bypass capacitors for most applications. If, however, the power supplies are remotely located (farther than 10 feet or so) or if they are likely to carry more than a few millivolts of noise, local filtering will enable the user to retain optimal performance.

Reference and sense pins are provided to permit remote load

sensing. These points can also be used to trim the device CMR, add an output booster, or to offset the output to a reference level. These applications are illustrated in following sections.

It is good practice to place  $R_G$  within several inches of the AD522. Longer leads will increase stray capacitance and cause phase shifts that will degrade CMR at higher frequencies. For frequencies below 10Hz, a remote  $R_G$  is generally acceptable; no stability problems are caused. Bear in mind that a leakage impedance of  $200M\Omega$  between  $R_G$  pins will cause an 0.1% gain error at  $G = 1$ . Unity gain is not trimmable.

**TYPICAL APPLICATION AND ERROR BUDGET ANALYSIS (See Figure 1 and Table I)**

A floating transducer with a 0 to 1 volt output has a  $1k\Omega$  source imbalance. A noisy environment induces a one volt 0 to 60Hz common mode signal in the ground return. This signal must be amplified to interface with a data acquisition system calibrated for a 0 to 10 volt signal range. The operating temperature range is 0 to  $+50^\circ C$  and an AD522B is to be used. Table 1 lists error sources and their effect on system accuracy.

The total effect on absolute accuracy is less than  $\pm 0.2\%$ , allowing adjustment-free 8-bit operation. In computer or microprocessor controlled data-acquisition systems, automatic recalibration can nullify gain and offset drifts leaving noise, distortion and CMR as the only error sources. In this case, full 12-bit operation is achieved.

**Gain Errors:** Absolute gain errors can be nulled by trimming  $R_G$ . Gain drift is a linear effect, not detrimental to resolution and is caused by the change in value of internal resistors over the operating temperature range. An "intelligent" system can correct for these errors with an automatic calibration cycle. Gain nonlinearity never exceeds 0.002% at  $G = 10$ .

**Offset Drift & Pins Current Errors:** Special care has been taken in the design of the AD522 input stage to minimize offset drift. Unless transducer impedances are unbalanced by more than  $2k\Omega$ , errors caused by offset current drift are negligible compared to offset voltage drift. Although initial offset voltages are laser-nulled for most applications, provisions have been made to allow further adjustment to correct for initial system offset. In this example, all offset drifts amount to  $\pm 0.014\%$  and do not effect resolution (can be corrected with an automatic calibration cycle).

**CMR and Noise Errors:** Common mode rejection and noise performance of instrumentation amplifiers are critical because

Error Source	Specification	Effect on Absolute Accuracy, % of F.S.	Effect on Resolution % of F.S.
Gain Nonlinearity	$\pm 0.002\%$ max, $G = 10$ (from Spec. Sheet and Fig. 4)	$\pm 0.002$	$\pm 0.002$
Voltage Drift	$\frac{25\mu V}{^\circ C} \times \frac{1}{Gain} + 2.0\mu V/^\circ C = 4.5\mu V/^\circ C$ R.T.I. = $0.00055\%/^\circ C$ (from Spec. Sheet)	$\pm 0.011$	---
CMR	86dB (from Spec. Sheet, CMR vs. F vs. G, typical curve)	$\pm 0.005$	$\pm 0.005$
Noise, R.T.O. (0.1 to 100Hz)	$15\mu V$ (p-p) R.T.O. (from Spec. Sheet, Noise vs. G typical curve)	$\pm 0.0015$	$\pm 0.0015$
Offset Current Drift	$\pm 50pA/^\circ C \times 1k$ source imbalance (Spec. Sheet) = $\pm 50\mu V/^\circ C$ $\pm 1.25\mu V$ R.T.I.	$\pm 0.000125$	---
Gain Drift (add 10ppm/°C for external $R_G$ )	$60ppm/^\circ C$ (Spec. Sheet)	$\pm 0.15$	---

Table I. Error Sources

**PIN CONFIGURATION**

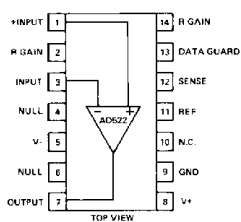

these errors can not be corrected by calibration. Common mode rejection of the AD522 is active laser-trimmed to the limits of thin-film resistor stability. Further trimming could improve CMR on a short term basis, but regular readjustment would be necessary to maintain this improvement (see Figure 2). In this example, untrimmed CMR and noise cause a total error of  $\pm 0.0065\%$  of full scale and are the major contributors to resolution error.

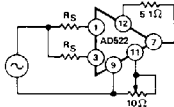

Figure 2. Optional CMR Trim

### PERFORMANCE CHARACTERISTICS

**Offset Voltage and Current Drift:** The AD522 is available in four drift selections. Figure 3 is a graph of maximum RTO offset voltage drift vs. gain for all versions. Errors caused by offset voltage drift can thus be determined for any gain. Offset current drift will cause a voltage error equal to the product of the offset current drift and the source impedance unbalance.

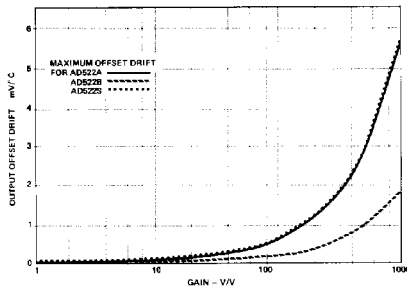

Figure 3. Output Offset Drift (RTO) vs. Gain

**Gain Nonlinearity and Noise:** Gain nonlinearity increases with gain as the device loop-gain decreases. Figure 4 is a plot of typical nonlinearity vs. gain. The shape of the curve can be safely used to predict worst-case nonlinearity at gains below 100. Noise vs. gain is shown on the same graph.

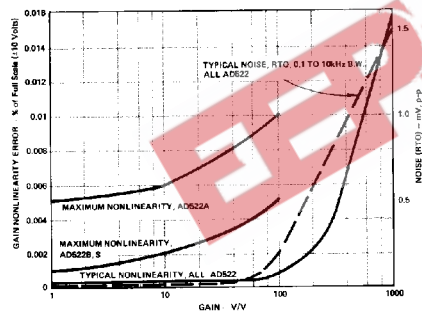

Figure 4. Gain Nonlinearity and Noise (RTO) vs. Gain

**Common Mode Rejection:** CMR is rated at  $\pm 10V$  and  $1k\Omega$  source imbalance. At lower gains, CMR depends mainly on thin-film resistor stability but due to gain-bandwidth considerations, is relatively constant with frequency to beyond 60Hz. The dc CMR improves with increasing gain and is increasingly subject to phase shifts in limited bandwidth high-gain amplifiers. Figure 5 illustrates CMR vs. Gain and Frequency.

**Dynamic Performance:** Settling time and unity gain bandwidth are directly proportional to gain. As a result, dynamic performance can be predicted from the well-behaved curves of Figure 6.

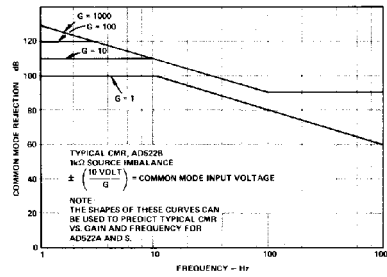

Figure 5. Common Mode Rejection vs. Frequency and Gain

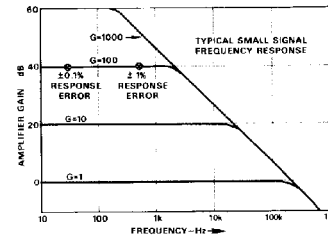

Figure 6. Small Signal Frequency Response (-3dB)

### SPECIAL APPLICATIONS

**Offset and Gain Trim:** Gain accuracy depends largely on the quality of  $R_G$ . A precision resistor with a  $10\text{ppm}/^\circ\text{C}$  temperature coefficient is advised. Offset, like gain, is laser-trimmed to a level suitable for most applications. If further adjustment is required, the circuit shown in Figure 1 is recommended. Note that good quality ( $25\text{ppm}$ ) pots are necessary to maintain voltage drift specifications.

**CMR Trim:** A short-term CMR improvement of up to 10dB at low gains can be realized with the circuit of Figure 2. Apply a low-frequency  $20/G$  volt peak-to-peak input signal to both inputs through their equivalent source resistances and trim the pot for an ac output null.

**Sense Output:** A sense output is provided to enable remote load sensing or use of an output current booster. Figure 7 illustrates these applications. Being "inside the loop", booster drift errors are minimized. When not used, the sense output should be tied to the output.

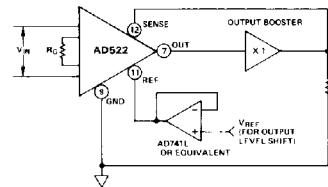

Figure 7. Output Current Booster and Buffered Output Level Shifter

**Reference Output:** The reference terminal is provided to permit the user to offset or "level shift" the output level to a datum compatible with his load. It must be remembered that the total output swing is  $\pm 10$  volts to be shared between signal and reference offset. Furthermore, any reference source resistance will unbalance the CMR trim by the ratio  $10k/R_{ref}$ . For example, if the reference source impedance is  $1\Omega$ , CMR will be reduced to 80dB ( $10k\Omega/1\Omega = 10,000 = 80\text{dB}$ ). A buffer amplifier can be used to eliminate this error, as shown in Figure 7, but the drift of the buffer will add to output offset drift. When not used, the reference terminal should be grounded.