

## ADC08061/ADC08062

### 500 ns A/D Converter with S/H Function and Input Multiplexer

#### General Description

Using a patented multi-step A/D conversion technique, the 8-bit ADC08061 and ADC08062 CMOS ADCs offer 500 ns (typ) conversion time, internal sample-and-hold (S/H), and dissipate only 125 mW of power. The ADC08062 has a two-channel multiplexer. The ADC08061/2 family performs an 8-bit conversion using a 2-bit voltage estimator that generates the 2 MSBs and two low-resolution (3-bit) flashes that generate the 6 LSBs.

Input track-and-hold circuitry eliminates the need for an external sample-and-hold. The ADC08061/2 family performs accurate conversions of full-scale input signals that have a frequency range of DC to 300 kHz (full-power bandwidth) without need of an external S/H.

The digital interface has been designed to ease connection to microprocessors and allows the parts to be I/O or memory mapped.

#### Key Specifications

■ Resolution	8 bits
■ Conversion Time	560 ns max ( $\overline{WR}$ - $\overline{RD}$ Mode)
■ Full Power Bandwidth	300 kHz
■ Throughput rate	1.5 MHz
■ Power Dissipation	100 mW max
■ Total Unadjusted Error	$\pm 1/2$ LSB and $\pm 1$ LSB

#### Features

- 1 or 2 input channels
- No external clock required
- Analog input voltage range from GND to V<sup>+</sup>
- Overflow output available for cascading (ADC08061)
- ADC08061 pin-compatible with the industry standard ADC0820

#### Applications

- Mobile telecommunications
- Hard disk drives
- Instrumentation
- High-speed data acquisition systems

#### Block Diagram

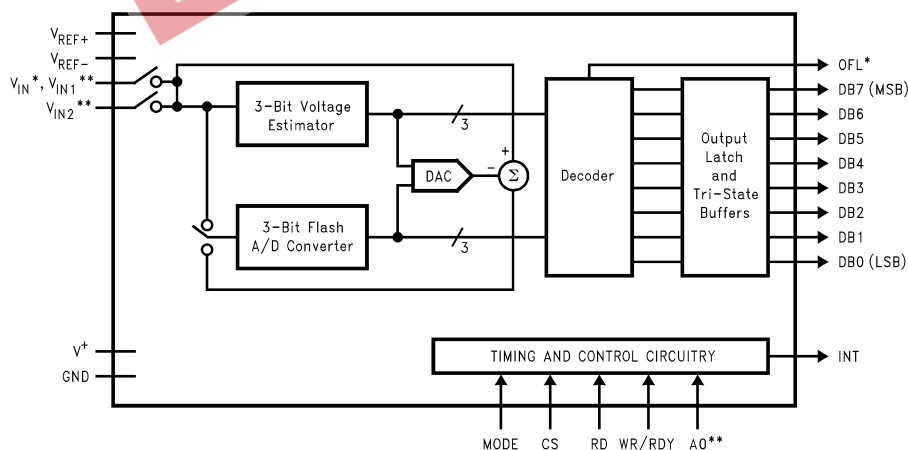

\* ADC08061  
\*\* ADC08062

DS011086-1

TRI-STATE® is a registered trademark of National Semiconductor Corporation.

## Connection Diagrams

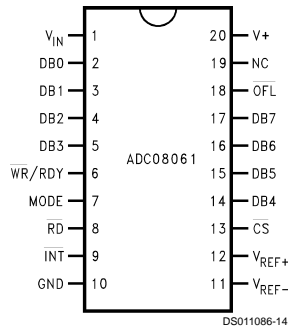

Dual-In-Line and Wide-Body  
Small-Outline  
Packages N20A or M20B

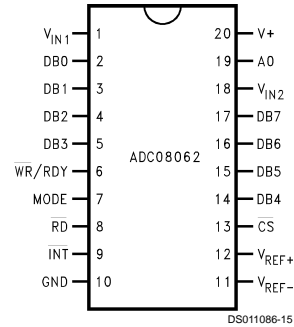

Dual-In-Line and Wide-Body  
Small-Outline  
Packages N20A or M20B

## Ordering Information

Industrial ( $-40^{\circ}\text{C} \leq T_A \leq 85^{\circ}\text{C}$ )	Package
ADC08061BIN, ADC08062BIN	N20A
ADC08061CIWM, ADC08062CIWM	M20B

## Pin Description

$V_{IN}$ , $V_{IN1-8}$	These are analog inputs. The input range is $\text{GND} - 50 \text{ mV} \leq V_{\text{INPUT}} \leq V^+ + 50 \text{ mV}$ . The ADC08061 has a single input ( $V_{IN}$ ) and the ADC08062 has a two-channel multiplexer ( $V_{IN1-2}$ ).
DB0–DB7	TRI-STATE data outputs—bit 0 (LSB) through bit 7 (MSB).
$\overline{\text{WR}}/\text{RDY}$	<b>WR-RD Mode</b> (Logic high applied to MODE pin) <b>WR:</b> With $\overline{\text{CS}}$ low, the conversion is started on the falling edge of $\overline{\text{WR}}$ . The digital result will be strobed into the output latch at the end of conversion (see Figures 2, 3, 4).
$\text{RD}$	<b>RD Mode</b> (Logic low applied to MODE pin) <b>RDY:</b> This is an open drain output (no internal pull-up device). RDY will go low after the falling edge of $\overline{\text{CS}}$ and return high at the end of conversion.
MODE	<b>Mode:</b> Mode ( $\overline{\text{RD}}$ or $\overline{\text{WR-RD}}$ ) selection input—This pin is pulled to a logic low through an internal 50 $\mu\text{A}$ current sink when left unconnected. <b>RD Mode</b> is selected if the MODE pin is left unconnected or externally forced low. A complete conversion is accomplished by pulling $\overline{\text{RD}}$ low until output data appears. <b>WR-RD Mode</b> is selected when a high is applied to the MODE pin. A conversion starts with the $\overline{\text{WR}}$ signal's rising edge and then using $\overline{\text{RD}}$ to access the data.
$\overline{\text{RD}}$	<b>WR-RD Mode</b> (logic high on the MODE pin) This is the active low Read input. With a logic low applied to the $\overline{\text{CS}}$ pin, the TRI-STATE data outputs (DB0–DB7) will be activated when $\overline{\text{RD}}$ goes low (Figures 2, 3, 4). <b>RD Mode</b> (logic low on the MODE pin)

$\overline{\text{INT}}$	With $\overline{\text{CS}}$ low, a conversion starts on the falling edge of $\overline{\text{RD}}$ . Output data appears on DB0–DB7 at the end of conversion (see Figures 1, 5). This is an active low output that indicates that a conversion is complete and the data is in the output latch. $\overline{\text{INT}}$ is reset by the rising edge of $\overline{\text{RD}}$ .
GND	This is the power supply ground pin. The ground pin should be connected to a "clean" ground reference point.
$V_{\text{REF}-}$ , $V_{\text{REF}+}$	These are the reference voltage inputs. They may be placed at any voltage between $\text{GND} - 50 \text{ mV}$ and $V^+ + 50 \text{ mV}$ , but $V_{\text{REF}+}$ must be greater than $V_{\text{REF}-}$ . Ideally, an input voltage equal to $V_{\text{REF}-}$ produces an output code of 0, and an input voltage greater than $V_{\text{REF}+} - 1.5 \text{ LSB}$ produces an output code of 255. For the ADC08062, an input voltage on any unselected input that exceeds $V^+$ by more than 100 mV or is below $\text{GND}$ by more than 100 mV will create errors in a selected channel that is operating within proper operating conditions.
$\overline{\text{CS}}$	This is the active low Chip Select input. A logic low signal applied to this input pin enables the $\overline{\text{RD}}$ and $\overline{\text{WR}}$ inputs. Internally, the $\overline{\text{CS}}$ signal is ORed with $\overline{\text{RD}}$ and $\overline{\text{WR}}$ signals.
$\overline{\text{OFL}}$	Overflow Output. If the analog input is higher than $V_{\text{REF}+} - \frac{1}{2} \text{ LSB}$ , $\overline{\text{OFL}}$ will be low at the end of conversion. It can be used when cascading two ADC08061s to achieve higher resolution (9 bits). This output is always active and does not go into TRI-STATE as DB0–DB7 do. When $\overline{\text{OFL}}$ is set, all data outputs remain high when the ADC08061's output data is read.
NC	No connection.

## Pin Description (Continued)

A0 This logic input is used to select one of the ADC08062's input multiplexer channels. A channel is selected as shown in the table below.

ADC08062 A0	Channel
0	$V_{IN1}$
1	$V_{IN2}$

V<sup>+</sup> Positive power supply voltage input. Nominal operating supply voltage is +5V. The supply pin should be bypassed with a 10  $\mu$ F bead tantalum in parallel with a 0.1 ceramic capacitor. Lead length should be as short as possible.

EEPW 电子产品世界  
.com.cn

## Absolute Maximum Ratings (Notes 1, 2)

If Military/Aerospace specified devices are required, please contact the National Semiconductor Sales Office/Distributors for availability and specifications.

Supply Voltage (V <sup>+</sup> )	6V
Logic Control Inputs	-0.3V to V <sup>+</sup> + 0.3V
Voltage at Other Inputs and Outputs	-0.3V to V <sup>+</sup> + 0.3V
Input Current at Any Pin (Note 3)	5 mA
Package Input Current (Note 3)	20 mA
Power Dissipation (Note 4)	
J Package	875 mW
N Package	875 mW
WM Package	875 mW
Storage Temperature	-65°C to +150°C

Lead Temperature (Note 5)

J Package (Soldering, 10 sec.)	+300°C
N Package (Soldering, 10 sec.)	+260°C
WM Package	
(Vapor Phase, 60 sec.)	+215°C
WM Package (Infrared, 15 sec.)	+220°C
ESD Susceptibility (Note 6)	2 kV

## Operating Ratings (Notes 1, 2)

Temperature Range	$T_{MIN} \leq T_A \leq T_{MAX}$
ADC08061/2BIN,	
ADC08061/2CIWM	-40°C ≤ T <sub>A</sub> ≤ 85°C
Supply Voltage, (V <sup>+</sup> )	4.5V to 5.5V

## Converter Characteristics

The following specifications apply for RD Mode, V<sup>+</sup> = 5V, V<sub>REF+</sub> = 5V, and V<sub>REF-</sub> = GND unless otherwise specified. **Bold-face limits apply for T<sub>A</sub> = T<sub>J</sub> = T<sub>MIN</sub> to T<sub>MAX</sub>**; all other limits T<sub>A</sub> = T<sub>J</sub> = 25°C.

Symbol	Parameter	Conditions	Typical (Note 7)	Limits (Note 8)	Units (Limit)
INL	Integral Non Linearity	ADC08061/2BIN		<b>±1/2</b>	LSB (max)
		ADC08061/2CIWM		<b>±1</b>	LSB (max)
TUE	Total Unadjusted Error	ADC08061/2BIN		<b>±1/2</b>	LSB (max)
		ADC08061/2CIWM		<b>±1</b>	LSB (max)
	Missing Codes			<b>0</b>	Bits (max)
	Reference Input Resistance		700	<b>500</b>	Ω(min)
			700	<b>1250</b>	Ω (max)
V <sub>REF+</sub>	Positive Reference Input Voltage			<b>V<sub>REF-</sub></b> <b>V<sup>+</sup></b>	V (min) V (max)
V <sub>REF-</sub>	Negative Reference Input Voltage			<b>GND</b> <b>V<sub>REF+</sub></b>	V (min) V (max)
V <sub>IN</sub>	Analog Input Voltage	(Note 10)		<b>GND - 0.1</b> <b>V<sup>+</sup> + 0.1</b>	V (min) V (max)
	On Channel Input Current	On Channel Input = 5V, Off Channel Input = 0V (Note 11)	-0.4	<b>-20</b>	μA (max)
		On Channel Input = 0V, Off Channel Input = 5V (Note 11)	-0.4	<b>-20</b>	μA (max)
PSS	Power Supply Sensitivity	V <sup>+</sup> = 5V ±5%, V <sub>REF</sub> = 4.75V All Codes Tested	±1/16	<b>±1/2</b>	LSB (max)
	Effective Bits		7.8		Bits
	Full-Power Bandwidth		300		kHz
THD	Total Harmonic Distortion		0.5		%
S/N	Signal-to-Noise Ratio		50		dB
IMD	Intermodulation Distortion		50		dB

## AC Electrical Characteristics

The following specifications apply for V<sup>+</sup> = 5V, t<sub>r</sub> = t<sub>f</sub> = 10 ns, V<sub>REF+</sub> = 5V, V<sub>REF-</sub> = 0V unless otherwise specified. **Bold-face limits apply for T<sub>A</sub> = T<sub>J</sub> = T<sub>MIN</sub> to T<sub>MAX</sub>**; all other limits T<sub>A</sub> = T<sub>J</sub> = 25°C.

Symbol	Parameter	Condition	Typical (Note 7)	Limits (Note 8)	Units (Limit)
t <sub>WR</sub>	Write Time	Mode Pin to V <sup>+</sup> ; (Figures 2, 3, 4)	100	<b>100</b>	ns (min)
t <sub>RD</sub>	Read Time (Time from Falling Edge of $\overline{WR}$ to Falling Edge of $\overline{RD}$ )	Mode Pin to V <sup>+</sup> ; (Figure 2)	350	<b>350</b>	ns (min)

## AC Electrical Characteristics (Continued)

The following specifications apply for  $V^+ = 5V$ ,  $t_r = t_f = 10$  ns,  $V_{REF+} = 5V$ ,  $V_{REF-} = 0V$  unless otherwise specified. **Boldface limits apply for  $T_A = T_J = T_{MIN}$  to  $T_{MAX}$** ; all other limits  $T_A = T_J = 25^\circ C$ .

Symbol	Parameter	Condition	Typical (Note 7)	Limits (Note 8)	Units (Limit)
$\overline{t_{RDW}}$	$\overline{RD}$ Width	Mode Pin to GND; (Figure 5)	200 400	<b>250</b> <b>400</b>	ns (min) ns (max)
$t_{CONV}$	$\overline{WR}$ - $\overline{RD}$ Mode Conversion Time ( $\overline{t_{WR}} + \overline{t_{RD}} + t_{ACC1}$ )	Mode Pin to $V^+$ ; (Figure 2)	500	<b>560</b>	ns (max)
$\overline{t_{CRD}}$	$\overline{RD}$ Mode Conversion Time	Mode Pin to GND; (Figure 1)	655	<b>900</b>	ns (max)
$t_{ACCO}$	Access Time (Delay from Falling Edge of $\overline{RD}$ to Output Valid)	$C_L \leq 100$ pF Mode Pin to GND; (Figure 1)	640	<b>900</b>	ns (max)
$t_{ACC1}$	Access Time (Delay from Falling Edge of $\overline{RD}$ to Output Valid)	$C_L \leq 10$ pF $C_L = 100$ pF Mode Pin to $V^+$ , $\overline{t_{RD}} \leq \overline{t_{INTL}}$ (Figure 2)	45 50	<b>110</b>	ns (max)
$t_{ACC2}$	Access Time (Delay from Falling Edge of $\overline{RD}$ to Output Valid)	$C_L \leq 10$ pF $C_L = 100$ pF $\overline{t_{RD}} > \overline{t_{INTL}}$ ; (Figures 3, 4)	25 30	<b>55</b>	ns (max)
$t_{0H}$	TRI-STATE® Control (Delay from Rising Edge of $\overline{RD}$ to HI-Z State)	$R_L = 3$ k $\Omega$ , $C_L = 10$ pF	30	<b>60</b>	ns (max)
$t_{1H}$	TRI-STATE Control (Delay from Rising Edge of $\overline{RD}$ to HI-Z State)	$R_L = 3$ k $\Omega$ , $C_L = 10$ pF	30	<b>60</b>	ns (max)
$\overline{t_{INTL}}$	Delay from Rising Edge of $\overline{WR}$ to Falling Edge of $\overline{INT}$	(Figures 3, 4) Mode Pin = $V^+$ , $C_L = 50$ pF	520	<b>690</b>	ns (max)
$\overline{t_{INTH}}$	Delay from Rising Edge of $\overline{RD}$ to Rising Edge of $\overline{INT}$	$C_L = 50$ pF; (Figures 1, 2, 3, 4, 2b, and 4)	50	<b>95</b>	ns (max)
$\overline{t_{INTH}}$	Delay from Rising Edge of $\overline{WR}$ to Rising Edge of $\overline{INT}$	$C_L = 50$ pF; (Figure 4)	45	<b>95</b>	ns (max)
$t_{RDY}$	Delay from $\overline{CS}$ to RDY	Mode Pin = 0V, $C_L = 50$ pF, $R_L = 3$ k $\Omega$ (Figure 1)	25	<b>45</b>	ns (max)
$t_{ID}$	Delay from $\overline{INT}$ to Output Valid	$R_L = 3$ k $\Omega$ , $C_L = 100$ pF; (Figure 4)	0	<b>15</b>	ns (max)
$t_{RI}$	Delay from $\overline{RD}$ to $\overline{INT}$	Mode Pin = $V^+$ , $\overline{t_{RD}} \leq \overline{t_{INTL}}$ ; (Figure 3)	60	<b>115</b>	ns (max)
$t_N$	Time between End of $\overline{RD}$ and Start of New Conversion	(Figures 1, 2, 3, 4, 5)	50	<b>50</b>	ns (min)
$t_{AH}$	Channel Address Hold Time	(Figures 1, 2, 3, 4, 5)	10	<b>60</b>	ns (min)
$t_{AS}$	Channel Address Setup Time	(Figures 1, 2, 3, 4, 5)	0	<b>0</b>	ns (max)
$t_{CSS}$	$\overline{CS}$ Setup Time	(Figures 1, 2, 3, 4, 5)	0	<b>0</b>	ns (max)
$t_{CSH}$	$\overline{CS}$ Hold Time	(Figures 1, 2, 3, 4, 5)	0	<b>0</b>	ns (min)
$C_{VIN}$	Analog Input Capacitance		25		pF
$C_{OUT}$	Logic Output Capacitance		5		pF
$C_{IN}$	Logic Input Capacitance		5		pF

## DC Electrical Characteristics

The following specifications apply for  $V^+ = 5V$  unless otherwise specified. **Boldface limits apply for  $T_A = T_J = T_{MIN}$  to  $T_{MAX}$** ; all other limits  $T_A = T_J = 25^\circ C$ .

Symbol	Parameter	Conditions	Typical (Note 7)	Limits (Note 8)	Units (Limit)
$V_{IH}$	Logic "1" Input Voltage	$V^+ = 5.5V$ Mode Pin		<b>3.5</b>	V (min)
		ADC08062 $\overline{CS}$ , $\overline{WR}$ , $\overline{RD}$ , A0 Pins		<b>2.2</b>	V (min)
		ADC08061 $\overline{CS}$ , $\overline{WR}$ , $\overline{RD}$ Pins		<b>2.0</b>	V (min)

## DC Electrical Characteristics (Continued)

The following specifications apply for  $V^+ = 5V$  unless otherwise specified. **Boldface limits apply for  $T_A = T_J = T_{MIN}$  to  $T_{MAX}$** ; all other limits  $T_A = T_J = 25^\circ C$ .

Symbol	Parameter	Conditions	Typical (Note 7)	Limits (Note 8)	Units (Limit)
$V_{IL}$	Logic "0" Input Voltage	$V^+ = 4.5V$ Mode Pin		<b>1.5</b>	V (max)
		ADC08062 $\overline{CS}$ , $\overline{WR}$ , $\overline{RD}$ , A0 Pins		<b>0.7</b>	V (max)
		ADC08061 $\overline{CS}$ , $\overline{WR}$ , $\overline{RD}$ Pins		<b>0.8</b>	V (max)
$I_{IH}$	Logic "1" Input Current	$V_{IH} = 5V$ $\overline{CS}$ , $\overline{RD}$ , A0 Pins	0.005	<b>1</b>	$\mu A$ (max)
		$\overline{WR}$ Pin	0.1	<b>3</b>	$\mu A$ (max)
		Mode Pin	50	<b>200</b>	$\mu A$ (max)
$I_{IL}$	Logic "0" Input Current	$V_{IL} = 0V$ $\overline{CS}$ , $\overline{RD}$ , $\overline{WR}$ , A0 Pins Mode Pin	-0.005	<b>-2</b>	$\mu A$ (max)
$V_{OH}$	Logic "1" Output Voltage	$V^+ = 4.75V$ $I_{OUT} = -360 \mu A$ DB0–DB7, $\overline{OFL}$ , $\overline{INT}$		<b>2.4</b>	V (min)
		$I_{OUT} = -10 \mu A$ DB0–DB7, $\overline{OFL}$ , $\overline{INT}$		<b>4.5</b>	V (min)
$V_{OL}$	Logic "0" Output Voltage	$V^+ = 4.75V$ $I_{OUT} = 1.6 mA$ DB0–DB7, $\overline{OFL}$ , $\overline{INT}$ , RDY		<b>0.4</b>	V (max)
$I_O$	TRI-STATE Output Current	$V_{OUT} = 5.0V$ DB0–DB7, RDY	0.1	<b>3</b>	$\mu A$ (max)
		$V_{OUT} = 0V$ DB0–DB7, RDY	-0.1	<b>-3</b>	$\mu A$ (max)
$I_{SOURCE}$	Output Source Current	$V_{OUT} = 0V$ DB0–DB7, $\overline{OFL}$ , $\overline{INT}$	-26	<b>-6</b>	mA (min)
$I_{SINK}$	Output Sink Current	$V_{OUT} = 5V$ DB0–DB7, $\overline{OFL}$ , $\overline{INT}$ , RDY	24	<b>7</b>	mA (min)
$I_C$	Supply Current	$\overline{CS} = \overline{WR} = \overline{RD} = 0$	11.5	<b>20</b>	mA (max)

**Note 1:** Absolute Maximum Ratings indicate limits beyond which damage to the device may occur. DC and AC electrical specifications do not apply when operating the device beyond its specified operating ratings. Operating Ratings indicate conditions for which the device is functional, but do not guarantee performance limits. For guaranteed specifications and test conditions, see the Electrical Characteristics. The guaranteed specifications apply only for the test conditions listed. Some performance characteristics may degrade when the device is not operated under the listed test conditions.

**Note 2:** All voltages are measured with respect to the GND pin, unless otherwise specified.

**Note 3:** When the input voltage ( $V_{IN}$ ) at any pin exceeds the power supply voltage ( $V_{IN} < GND$  or  $V_{IN} > V^+$ ), the absolute value of the current at that pin should be limited to 5 mA or less. The 20 mA package input current specification limits the number of pins that can exceed the power supply boundaries with a 5 mA current limit to four.

**Note 4:** The power dissipation of this device under normal operation should never exceed 875 mW (Quiescent Power Dissipation + the loads on the digital outputs). Caution should be taken not to exceed absolute maximum power rating when the device is operating in a severe fault condition (e.g., when any input or output exceeds the power supply). The maximum power dissipation must be derated at elevated temperatures and is dictated by  $T_{JMAX}$  (maximum junction temperature),  $\theta_{JA}$  (package junction to ambient thermal resistance), and  $T_A$  (ambient temperature). The maximum allowable power dissipation at any temperature is  $PD_{max} = (T_{JMAX} - T_A)/\theta_{JA}$  or the number given in the Absolute Maximum Ratings, whichever is lower. The table below details  $T_{JMAX}$  and  $\theta_{JA}$  for the various packages and versions of the ADC08061/2.

Part Number	$T_{JMAX}$	$\theta_{JA}$
ADC08061/2BIN	105	51
ADC08061/2CIWM	105	85

**Note 5:** See AN-450 "Surface Mounting Methods and Their Effect on Product Reliability" for other methods of soldering surface mount devices.

**Note 6:** Human body model, 100 pF discharged through a 1.5 k $\Omega$  resistor.

**Note 7:** Typicals are at 25 $^\circ C$  and represent most likely parametric norm.

## DC Electrical Characteristics (Continued)

**Note 8:** Limits are guaranteed to National's AOQL (Average Output Quality Level).

**Note 9:** Total unadjusted error includes offset, full-scale, and linearity errors.

**Note 10:** Two on-chip diodes are tied to each analog input and are reversed biased during normal operation. One is connected to  $V^+$  and the other is connected to GND. They will become forward biased and conduct when an analog input voltage is equal to or greater than one diode drop above  $V^+$  or below GND. Therefore, caution should be exercised when testing with  $V^+ = 4.5V$ . Analog inputs with magnitudes equal to  $5V$  can cause an input diode to conduct, especially at elevated temperatures. This can create conversion errors for analog signals near full-scale. The specification allows  $50\text{ mV}$  forward bias on either diode; e.g., the output code will be correct as long as the analog input signal does not exceed the supply voltage by more than  $50\text{ mV}$ . Exceeding this range on an unselected channel will corrupt the reading of a selected channel. An absolute analog input signal voltage range of  $0V \leq V_{IN} \leq 5V$  can be achieved by ensuring that the minimum supply voltage applied to  $V^+$  is  $4.950V$  over temperature variations, initial tolerance, and loading.

**Note 11:** Off-channel leakage current is measured after the on-channel selection.

## TRI-STATE Test Circuits and Waveforms

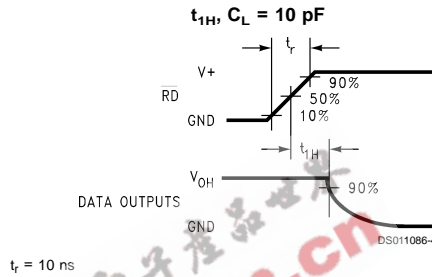
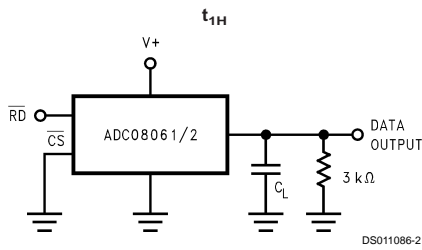

$t_r = 10\text{ ns}$

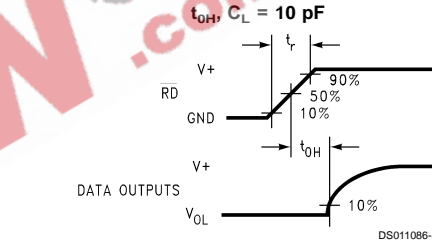
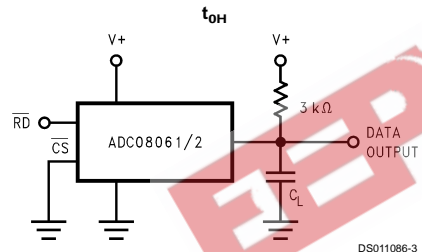

$t_r = 10\text{ ns}$

## Timing Diagrams

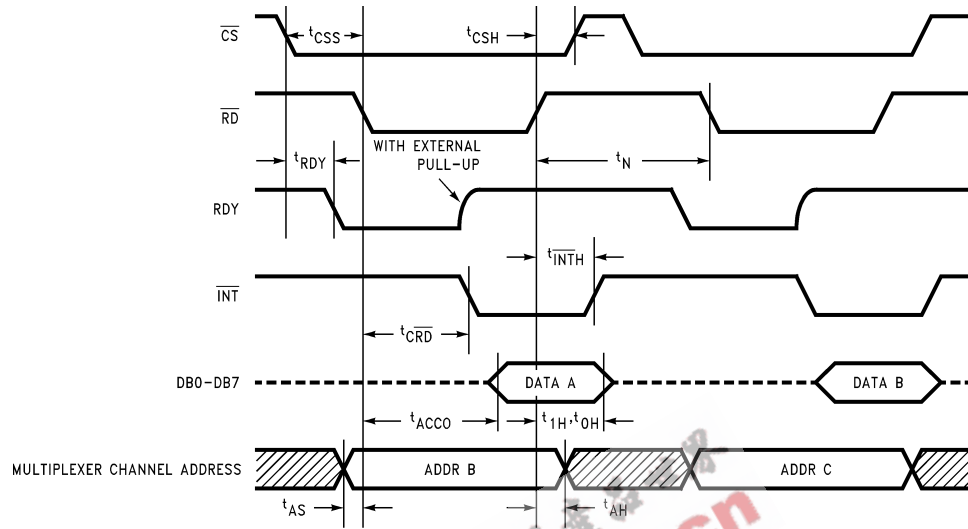

FIGURE 1. RD Mode (Mode Pin is Low)

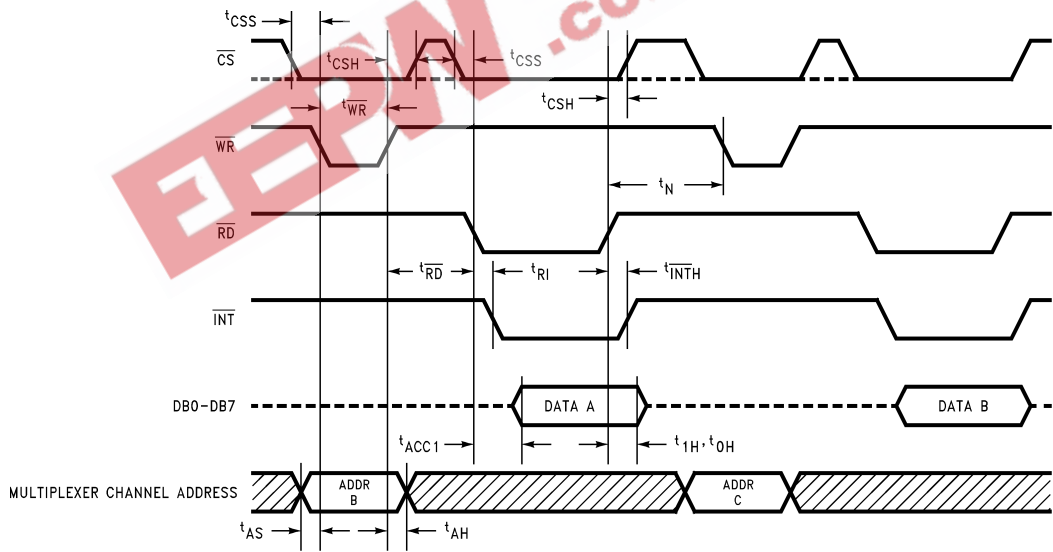
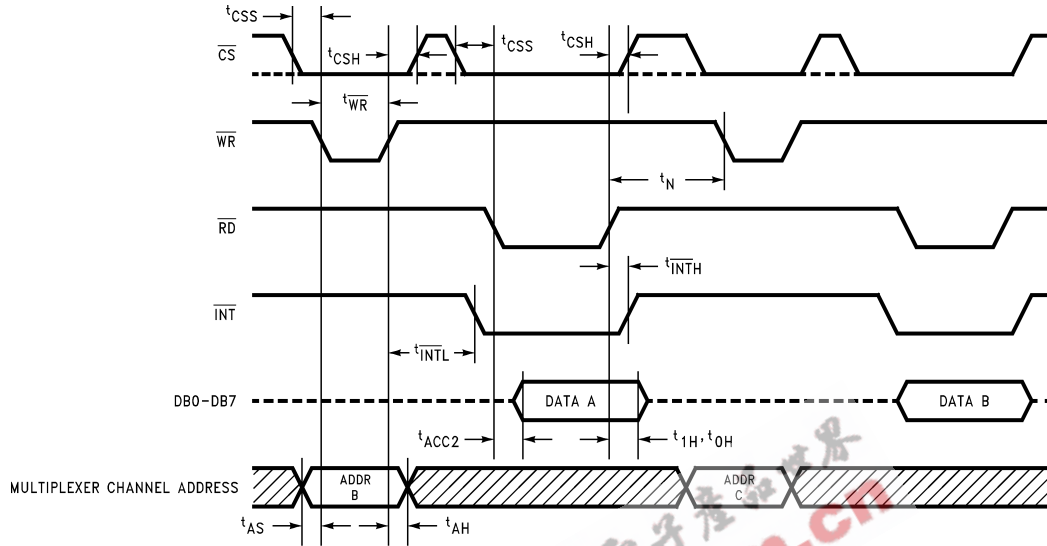

FIGURE 2. WR-RD Mode (Mode Pin is High and  $t_{RD} \leq t_{INTL}$ )



### Timing Diagrams (Continued)



DS011086-8

FIGURE 3.  $\overline{WR}$ - $\overline{RD}$  Mode (Mode Pin is High and  $t_{RD} > t_{INTL}$ )

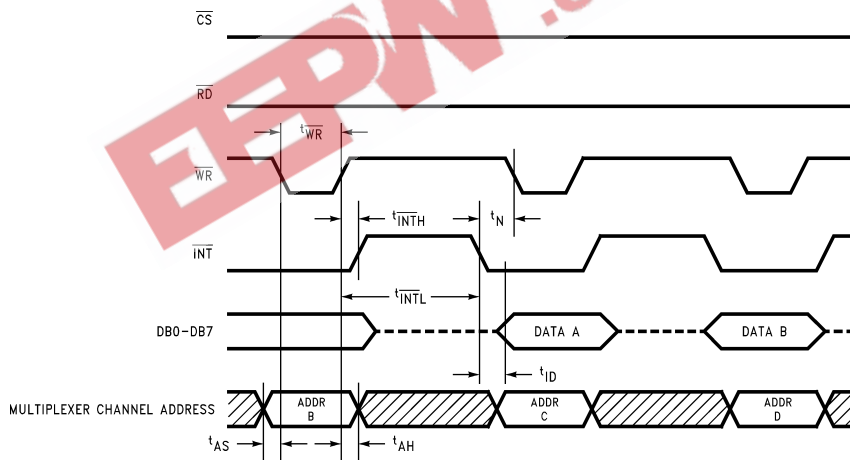

DS011086-9

FIGURE 4.  $\overline{WR}$ - $\overline{RD}$  Mode (Mode Pin is High) Reduced Interface System Connection ( $\overline{CS} = \overline{RD} = 0$ )

## Timing Diagrams (Continued)

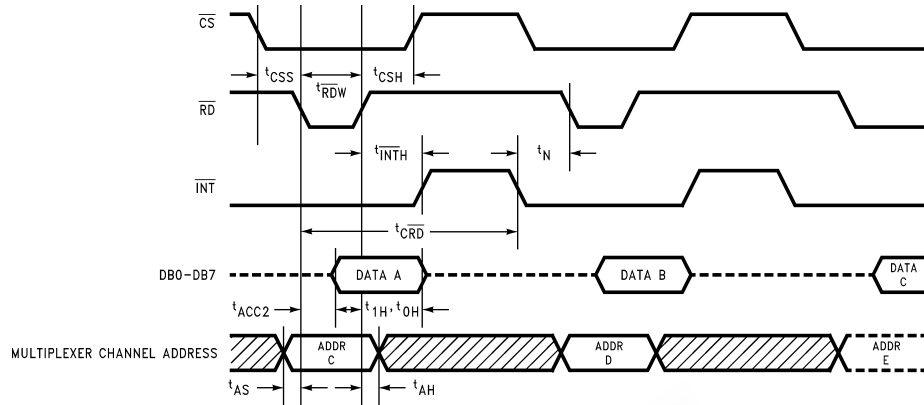

DS011086-10

FIGURE 5.  $\overline{RD}$  Mode (Pipeline Operation) (Mode Pin is Low and  $t_{RDW}$  must be between 200 ns and 400 ns)

## Typical Performance Characteristics

$t_{CRD}$  vs Temperature

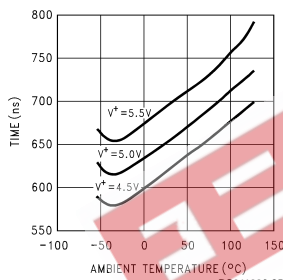

DS011086-25

Linearity Error vs Reference Voltage

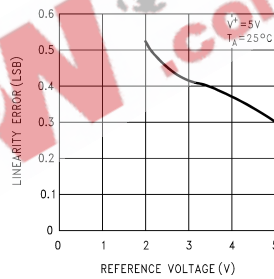

DS011086-26

Offset Error vs Reference Voltage

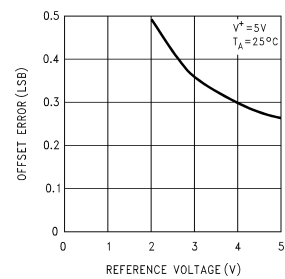

DS011086-27

Supply Current vs Temperature

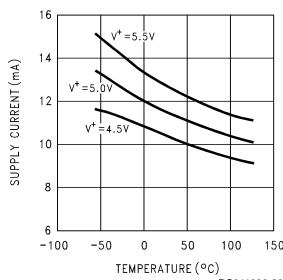

DS011086-28

Logic Threshold vs Temperature

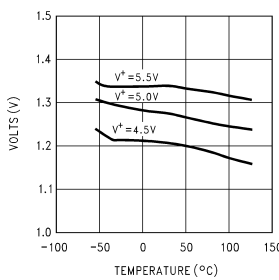

DS011086-29

Output Current vs Temperature

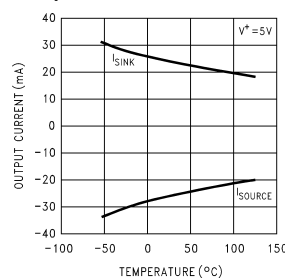

DS011086-30

## Application Information

### 1.0 FUNCTIONAL DESCRIPTION

The ADC08061 and ADC08062 perform an 8-bit analog-to-digital conversion using a multi-step flash technique. The first flash generates the five most significant bits (MSBs) and the second flash generates the three least significant bits (LSBs). Figure 6 shows the major functional blocks of the ADC08061/2's multi-step flash converter. It

consists of an over-encoded 2½-bit Voltage Estimator, an internal DAC with two different voltage spans, a 3-bit half-flash converter and a comparator multiplexer.

The resistor string near the center of the block diagram in Figure 6 forms the internal main DAC. Each of the eight resistors at the bottom of the string is equal to 1/256 of the total string resistance. These resistors form the **LSB Ladder** and

## Application Information (Continued)

have a voltage drop of  $1/256$  of the total reference voltage ( $V_{REF+} - V_{REF-}$ ) across them. The remaining resistors make up the **MSB Ladder**. They are made up of eight groups of four resistors connected in series. Each MSB Ladder section has  $1/8$  of the total reference voltage across it. Within a given MSB Ladder section, each of the MSB resistors has  $8/256$ , or  $1/32$  of the total reference voltage across it. Tap points are found between all of the resistors in both the MSB and LSB Ladders. Through the Comparator Multiplexer these tap points can be connected, in groups of eight, to the eight comparators shown at the right of *Figure 6*. This function provides the necessary reference voltages to the comparators during each flash conversion.

The six comparators, seven-resistor string (estimator DAC), and Estimator Decoder at the left of *Figure 6* form the Voltage Estimator. The estimator DAC connected between  $V_{REF+}$  and  $V_{REF-}$  generates the reference voltages for the six Voltage Estimator comparators. These comparators perform a very low resolution A/D conversion to obtain an "estimate" of the input voltage. This estimate is then used to control the Comparator Multiplexer, connecting the appropriate MSB Ladder section to the eight flash comparators. Only 14 comparators, six in the Voltage Estimator and eight in the flash converter, are needed to achieve the full eight-bit resolution, instead of 32 comparators that would be needed by traditional half-flash methods.

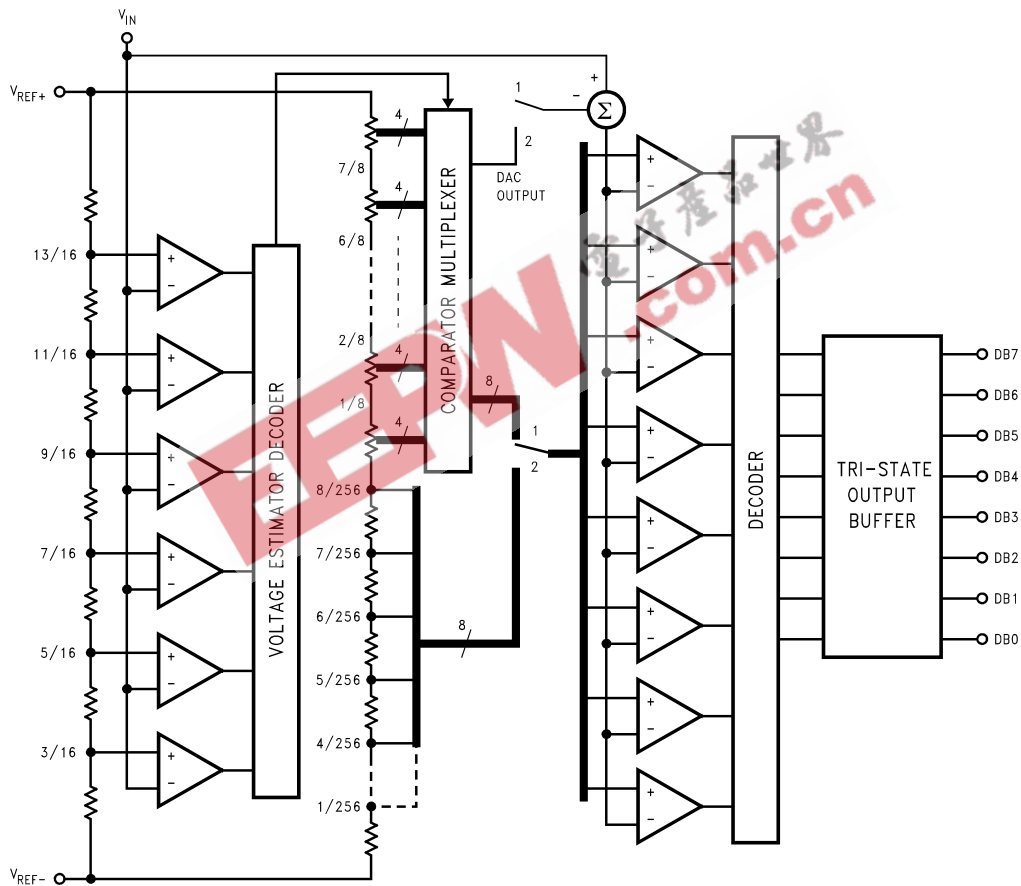

FIGURE 6. Block Diagram of the ADC08061/2 Multi-Step Flash Architecture

A conversion begins with the Voltage Estimator comparing the analog input signal against the six tap voltages on the estimator DAC. The estimator decoder then selects one of the groups of tap points along the MSB Ladder. These eight tap points are then connected to the eight flash comparators. For example, if the analog input signal applied to  $V_{IN}$  is between 0 and  $3/16$  of  $V_{REF}$  ( $V_{REF} = V_{REF+} - V_{REF-}$ ), the estimator decoder instructs the comparator multiplexer to select

the eight tap points between  $8/256$  and  $2/8$  of  $V_{REF}$  and connects them to the eight flash comparators. The first flash conversion is now performed, producing the five MSBs of data.

The remaining three LSBs are generated next using the same eight comparators that were used for the first flash conversion. As determined by the results of the MSB flash, a voltage from the MSB Ladder equivalent to the magnitude of

## Application Information (Continued)

the five MSBs is subtracted from the analog input voltage as the upper switch is moved from position one to position two. The resulting remainder voltage is applied to the eight flash comparators and, with the lower switch in position two, compared with the eight tap points from the LSB Ladder.

By using the same eight comparators for both flash conversions, the number of comparators needed by the multi-step converter is significantly reduced when compared to standard half-flash techniques.

Voltage Estimator errors as large as  $1/16$  of  $V_{REF}$  (16 LSBs) will be corrected since the flash comparators are connected to ladder voltages that extend beyond the range specified by the Voltage Estimator. For example, if  $7/16 V_{REF} < V_{IN} < 9/16 V_{REF}$  the Voltage Estimator's comparators tied to the tap points below  $9/16 V_{REF}$  will output "1"s (000111). This is decoded by the estimator decoder to "10". The eight flash comparators will be placed at the MSB Ladder tap points between  $3/8 V_{REF}$  and  $5/8 V_{REF}$ . The overlap of  $1/16 V_{REF}$  on each side of the Voltage Estimator's span will automatically correct an error of up to 16 LSBs (16 LSBs = 312.5 mV for  $V_{REF} = 5V$ ). If the first flash conversion determines that the input voltage is between  $3/8 V_{REF}$  and  $4/8 V_{REF} - LSB/2$ , the Voltage Estimator's output code will be corrected by subtracting "1". This results in a corrected value of "01". If the first flash conversion determines that the input voltage is between  $8/16 V_{REF} - LSB/2$  and  $5/8 V_{REF}$ , the Voltage Estimator's output code remains unchanged.

After correction, the 2-bit data from both the Voltage Estimator and the first flash conversion are decoded to produce the five MSBs. Decoding is similar to that of a 5-bit flash converter since there are 32 tap points on the MSB Ladder. However, 31 comparators are not needed since the Voltage Estimator places the eight comparators along the MSB Ladder where reference tap voltages are present that fall above and below the magnitude of  $V_{IN}$ . Comparators are not needed outside this selected range. If a comparator's output is a "0", all comparators above it will also have outputs of "0" and if a comparator's output is a "1", all comparators below it will also have outputs of "1".

### 2.0 DIGITAL INTERFACE

The ADC08061/2 has two basic interface modes which are selected by connecting the **MODE** pin to a logic high or low.

#### 2.1 $\overline{RD}$ Mode

With a logic low applied to the **MODE** pin, the converter is set to **Read** mode. In this configuration (see *Figure 1*), a complete version is done by pulling  $\overline{RD}$  low, and holding low, until the conversion is complete and output data appears. This typically takes 655 ns. The **INT** (interrupt) line goes low at the end of conversion. A typical delay of 50 ns is needed between the rising edge of  $\overline{RD}$  (after the end of a conversion) and the start of the next conversion (by pulling  $\overline{RD}$  low). The **RDY** output goes low after the falling edge of  $\overline{CS}$  and goes high at the end-of-conversion. It can be used to signal a processor that the converter is busy or serve as a system Transfer Acknowledge signal. For the ADC08062 the data generated by the first conversion cycle after power-up is from an unknown channel.

#### 2.2 $\overline{RD}$ Mode Pipelined Operation

Applications that require shorter  $\overline{RD}$  pulse widths than those used in the **Read** mode as described above can be achieved by setting  $\overline{RD}$ 's width between 200 ns–400 ns (*Figure 5*).  $\overline{RD}$

pulse widths outside this range will create conversion linearity errors. These errors are caused by exercising internal interface logic circuitry using  $\overline{CS}$  and/or  $\overline{RD}$  during a conversion.

When  $\overline{RD}$  goes low, a conversion is initiated and the data from the previous conversion is available on the **DB0–DB7** outputs. Reading **D0–D7** for the first two times after power-up produces random data. The data will be valid during the third  $\overline{RD}$  pulse that occurs after the first conversion.

#### 2.3 $\overline{WR}$ - $\overline{RD}$ ( $\overline{WR}$ then $\overline{RD}$ ) Mode

The ADC08061/2 is in the  $\overline{WR}$ - $\overline{RD}$  mode with the **MODE** pin tied high. A conversion starts on the falling edge of the  $\overline{WR}$  signal. There are two options for reading the output data which relate to interface timing. If an interrupt-driven scheme is desired, the user can wait for the **INT** output to go low before reading the conversion result (see *Figure 3*). Typically, **INT** will go low 520 ns, maximum, after  $\overline{WR}$ 's rising edge. However, if a shorter conversion time is desired, the processor need not wait for **INT** and can exercise a read after only 350 ns (see *Figure 2*). If  $\overline{RD}$  is pulled low before **INT** goes low, **INT** will immediately go low and data will appear at the outputs. This is the fastest operating mode ( $t_{RD} \leq t_{INTL}$ ) with a conversion time, including data access time, of 560 ns. Allowing 100 ns for reading the conversion data and the delay between conversions gives a total throughput time of 660 ns (throughput rate of 1.5 MHz).

#### 2.4 $\overline{WR}$ - $\overline{RD}$ Mode with Reduced Interface System Connection

$\overline{CS}$  and  $\overline{RD}$  can be tied low, using only  $\overline{WR}$  to control the start of conversion for applications that require reduced digital interface while operating in the  $\overline{WR}$ - $\overline{RD}$  mode (*Figure 4*). Data will be valid approximately 705 ns following  $\overline{WR}$ 's rising edge.

#### 2.5 Multiplexer Addressing

The ADC08062 has 2 multiplexer inputs. These are selected using the **A0** multiplexer channel selection input. *Table 1* shows the input code needed to select a given channel. The multiplexer address is latched when received but the multiplexer channel is updated after the completion of the current conversion.

TABLE 1. Multiplexer Addressing

ADC08062 <b>A0</b>	Channel
0	$V_{IN1}$
1	$V_{IN2}$

The multiplexer address data must be valid at the time of  $\overline{RD}$ 's falling edge, remain valid during the conversion, and can go high after  $\overline{RD}$  goes high when operating in the **Read Mode**.

The multiplexer address data should be valid at or before the time of  $\overline{WR}$ 's falling edge, remain valid while  $\overline{WR}$  is low, and go invalid after  $\overline{WR}$  goes high when operating in the  $\overline{WR}$ - $\overline{RD}$  **Mode**.

#### 3.0 REFERENCE INPUTS

The two  $V_{REF}$  inputs of the ADC08061/2 are fully differential and define the zero to full-scale input range of the A to D converter. This allows the designer to vary the span of the analog input since this range will be equivalent to the voltage difference between  $V_{REF+}$  and  $V_{REF-}$ . Transducers with

## Application Information (Continued)

minimum output voltages above GND can also be compensated by connecting  $V_{REF-}$  to a voltage that is equal to this minimum voltage. By reducing  $V_{REF}$  ( $V_{REF} = V_{REF+} - V_{REF-}$ ) to less than 5V, the sensitivity of the converter can be increased (i.e., if  $V_{REF} = 2.5V$ , then 1 LSB = 9.8 mV). The ADC08061/2's reference arrangement also facilitates ratiometric operation and in many cases the ADC08061/2's power supply can be used for transducer power as well as the  $V_{REF}$  source. Ratiometric operation is achieved by connecting  $V_{REF-}$  to GND and connecting  $V_{REF+}$  and a transducer's power supply input to  $V^+$ . The ADC08061/2's linearity degrades when  $V_{REF+} - |V_{REF-}|$  is less than 2.0V.

The voltage at  $V_{REF-}$  sets the input level that produces a digital output of all zeros. Though  $V_{IN}$  is not itself differential, the reference design affords nearly differential-input capability for some measurement applications. Figure 7 shows one possible differential configuration.

It should be noted that, while the two  $V_{REF}$  inputs are fully differential, the digital output will be zero for any analog input voltage if  $V_{REF-} \geq V_{REF+}$ .

### 4.0 ANALOG INPUT AND SOURCE IMPEDANCE

The ADC08061/2's analog input circuitry includes an analog switch with an "on" resistance of 70Ω and capacitance of 1.4 pF and 12 pF (see Figure 7). The switch is closed during the A/D's input signal acquisition time (while  $\overline{WR}$  is low when using the  $\overline{WR}$ -RD Mode). A small transient current flows into the input pin each time the switch closes. A transient voltage, whose magnitude can increase as the source impedance increases, may be present at the input. So long as the source impedance is less than 500Ω, the input voltage transient will not cause errors and need not be filtered.

Large source impedances can slow the charging of the sampling capacitors and degrade conversion accuracy. There-

fore, only signal sources with output impedances less than 500Ω should be used if rated accuracy is to be achieved at the minimum sample time (100 ns maximum). A signal source with a high output impedance should have its output buffered with an operational amplifier. Any ringing or voltage shifts at the op amp's output during the sampling period can result in conversion errors.

Correct conversion results will be obtained for input voltages greater than GND - 100 mV and less than  $V^+ + 100$  mV. Do not allow the signal source to drive the analog input pin more than 300 mV higher than  $V^+$ , or more than 300 mV lower than GND. The current flowing through any analog input pin should be limited to 5 mA or less to avoid permanent damage to the IC if an analog input pin is forced beyond these voltages. The sum of all the overdrive currents into all pins must be less than 20 mA. Some sort of protection scheme should be used when the input signal is expected to extend more than 300 mV beyond the power supply limits. A simple protection network using resistors and diodes is shown in Figure 9.

### 6.0 INHERENT SAMPLE-AND-HOLD

An important benefit of the ADC08061/2's input architecture is the inherent sample-and-hold (S/H) and its ability to measure relatively high speed signals without the help of an external S/H. In a non-sampling converter, regardless of its speed, the input must remain stable to at least 1/2 LSB throughout the conversion process if full accuracy is to be maintained. Consequently, for many high speed signals, this signal must be externally sampled and held stationary during the conversion.

The ADC08061 and ADC08062 are suitable for DSP-based systems because of the direct control of the S/H through the  $\overline{WR}$  signal. The  $\overline{WR}$  input signal allows the A/D to be synchronized to a DSP system's sampling rate or to other ADC08061 and ADC08062s.

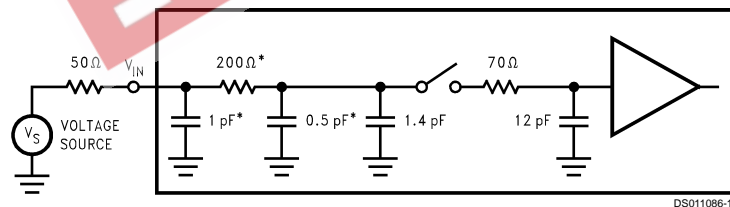

\*Represents a multiplexer channel in the ADC08062.

FIGURE 7. ADC08061 and ADC08062 Equivalent Input Circuit Model

## Application Information (Continued)

### External Reference 2.5V Full-Scale (Standard Application)

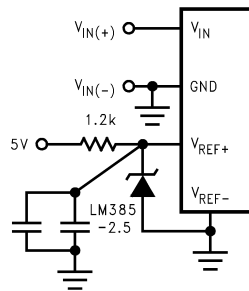

DS011086-20

**Note :** Bypass capacitors consist of a 0.1  $\mu\text{F}$  ceramic in parallel with a 10  $\mu\text{F}$  bead tantalum.

### Power Supply as Reference

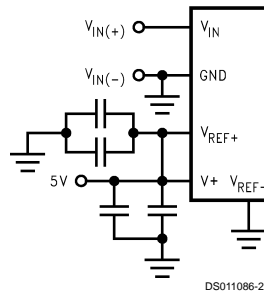

DS011086-21

### Input Not Referred to GND

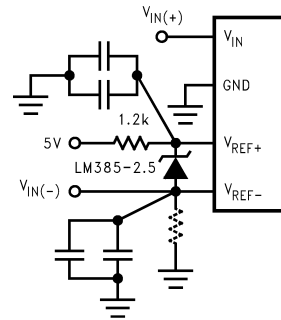

DS011086-22

\* Signal source driving  $V_{IN(-)}$  must be capable of sinking 5 mA.

FIGURE 8. Analog Input Options

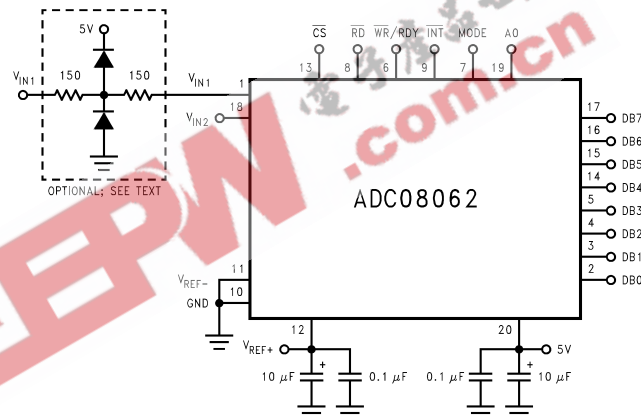

DS011086-23

Note the multiple bypass capacitors on the reference and power supply pins.  $V_{REF-}$  should be bypass to analog ground using multiple capacitors if it is not grounded (see Section 7.0 "Layout, Grounds, and Bypassing").  $V_{IN1}$  is shown with an optional input protection network.

FIGURE 9. Typical Connection

The ADC08061 can perform accurate conversions of full-scale input signals at frequencies from dc to more than 300 kHz (full power bandwidth) without the need of an external sample-and-hold (S/H).

### 7.0 LAYOUT, GROUNDS, AND BYPASSING

In order to ensure fast, accurate conversions from the ADC08061/2, it is necessary to use appropriate circuit board layout techniques. Ideally, the analog-to-digital converter's ground reference should be low impedance and free of noise from other parts of the system. Digital circuits can produce a great deal of noise on their ground returns and, therefore, should have their own separate ground lines. Best performance is obtained using separate ground planes for the digital and analog parts of the system.

The analog inputs should be isolated from noisy signal traces to avoid having spurious signals couple to the input. Any external component (e.g., an input filter capacitor) connected across the inputs should be returned to a very clean ground point. Incorrectly grounding the ADC08061/2 will result in reduced conversion accuracy.

The  $V^+$  supply pin,  $V_{REF+}$ , and  $V_{REF-}$  (if not grounded) should be bypassed with a parallel combination of a 0.1  $\mu\text{F}$  ceramic capacitor and a 10  $\mu\text{F}$  tantalum capacitor placed as close as possible to the supply pin using short circuit board traces. See Figures 8, 9.

**Physical Dimensions** inches (millimeters) unless otherwise noted

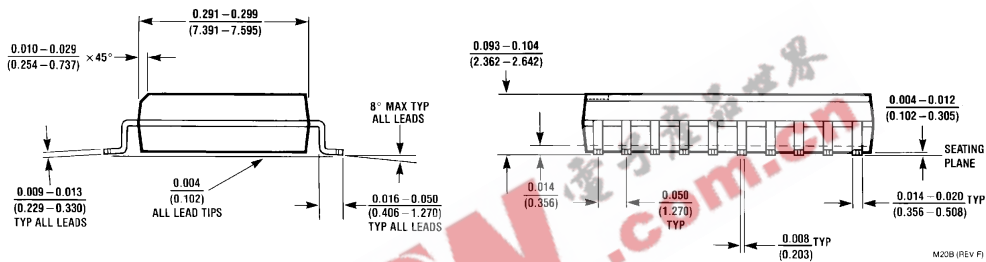
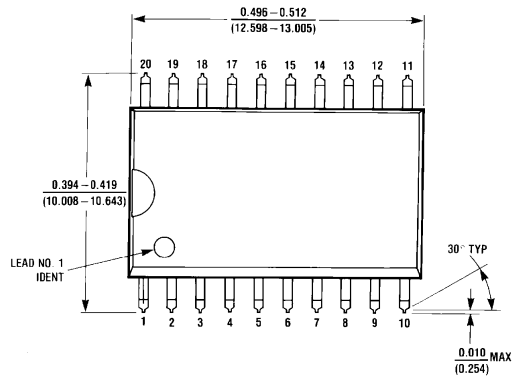

**Wide-Body Small-Outline Package (M)**  
 Order Number ADC08061CIWM, or ADC08062CIWM  
 NS Package Number M20B

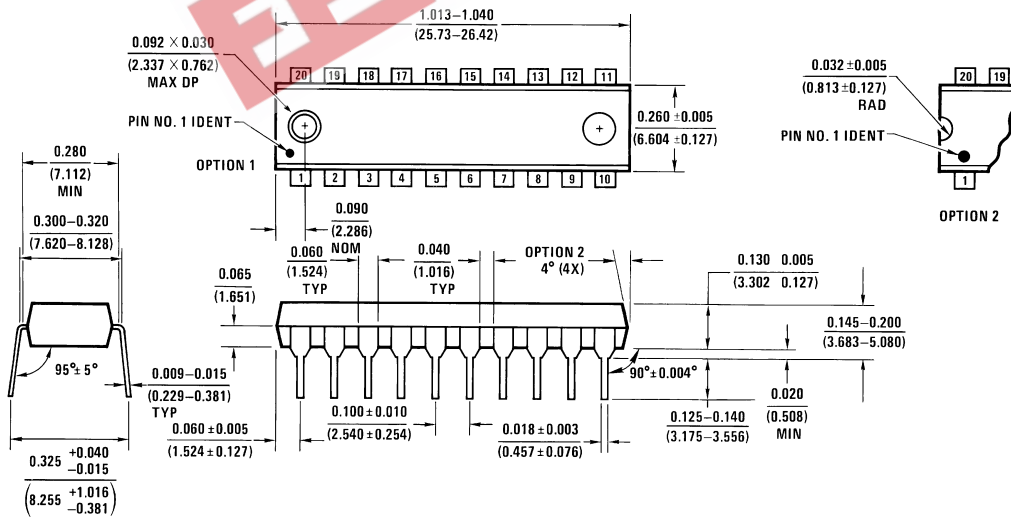

**Dual-In-Line Package (N)**  
 Order Number ADC08061BIN or ADC08062BIN  
 NS Package Number N20A

## Notes

EEPW 电子產品世界 .com.cn

### LIFE SUPPORT POLICY

NATIONAL'S PRODUCTS ARE NOT AUTHORIZED FOR USE AS CRITICAL COMPONENTS IN LIFE SUPPORT DEVICES OR SYSTEMS WITHOUT THE EXPRESS WRITTEN APPROVAL OF THE PRESIDENT AND GENERAL COUNSEL OF NATIONAL SEMICONDUCTOR CORPORATION. As used herein:

1. Life support devices or systems are devices or systems which, (a) are intended for surgical implant into the body, or (b) support or sustain life, and whose failure to perform when properly used in accordance with instructions for use provided in the labeling, can be reasonably expected to result in a significant injury to the user.
2. A critical component is any component of a life support device or system whose failure to perform can be reasonably expected to cause the failure of the life support device or system, or to affect its safety or effectiveness.



**National Semiconductor Corporation**  
Americas  
Tel: 1-800-272-9959  
Fax: 1-800-737-7018  
Email: support@nsc.com

www.national.com

**National Semiconductor Europe**  
Fax: +49 (0) 1 80-530 85 86  
Email: europe.support@nsc.com  
Deutsch Tel: +49 (0) 1 80-530 85 85  
English Tel: +49 (0) 1 80-532 78 32  
Français Tel: +49 (0) 1 80-532 93 58  
Italiano Tel: +49 (0) 1 80-534 16 80

**National Semiconductor Asia Pacific Customer Response Group**  
Tel: 65-2544466  
Fax: 65-2504466  
Email: sea.support@nsc.com

**National Semiconductor Japan Ltd.**  
Tel: 81-3-5639-7560  
Fax: 81-3-5639-7507