

ASCEND

Semiconductor

4Mx4 EDO

Data sheet

AD 40 4M 4 2 V S A - 5

Ascend
Semiconductor

EDO/FPM : 40
D-RAMBUS : 41
DDRSDRAM : 42
DDRSGRAM : 43
SGRAM : 46
SDRAM : 48

Density

16M : 16 Mega Bits
8M : 8 Mega Bits
4M : 4 Mega Bits
2M : 2 Mega Bits
1M : 1 Mega Bit

Organization

4: x4
8 : x8
9 : x9
16 : x16
18 : x18
32 : x32

Refresh

1 : 1K 8 : 8K
2 : 2K 6 : 16K
4 : 4K

Interface

V: 3.3V
R: 2.5V

Min Cycle Time (Max Freq.)

-5 : 5ns (200MHz)
-6 : 6ns (167MHz)
-7 : 7ns (143MHz)
-7.5 : 7.5ns (133MHz)
-8 : 8ns (125MHz)
-10 : 10ns (100MHz)

EDO : -5 (50 ns)
-6 (60 ns)

Revision

A : 1st B : 2nd
C : 3rd D : 4th

Package

C: CSP B: uBGA
T: TSOP Q: TQFP
P: PQFP (QFP)
L: LQFP S: SOJ



Description

The device CMOS Dynamic RAM organized as 4,194,304 words x 4 bits with extended data out access mode. It is fabricated with an advanced submicron CMOS technology and designed to operate from a single 3.3V only power supply. Low voltage operation is more suitable to be used on battery backup, portable electronic application. It is packaged in JEDEC standard 26/24-pin plastic SOJ or TSOP(II).

Features

- Single 3.3V($\pm 10\%$) only power supply
- High speed t_{RAC} access time: 50/60ns
- Low power dissipation
 - Active mode : 432/396 mW (Mas)
 - Standby mode: 0.54 mW (Mas)
- Extended - data - out(EDO) page mode access
- I/O level: CMOS level ($V_{cc} = 3.3V$)
- 2048 refresh cycle in 32 ms(Std.) or 128 ms(S-version)
- 4 refresh modes:
 - \overline{RAS} only refresh
 - CAS - before - \overline{RAS} refresh
 - Hidden refresh
 - Self-refresh(S-version)

EEPW.com.cn 电子产品世界

Pin Configuration

26/24-PIN 300mil Plastic SOJ

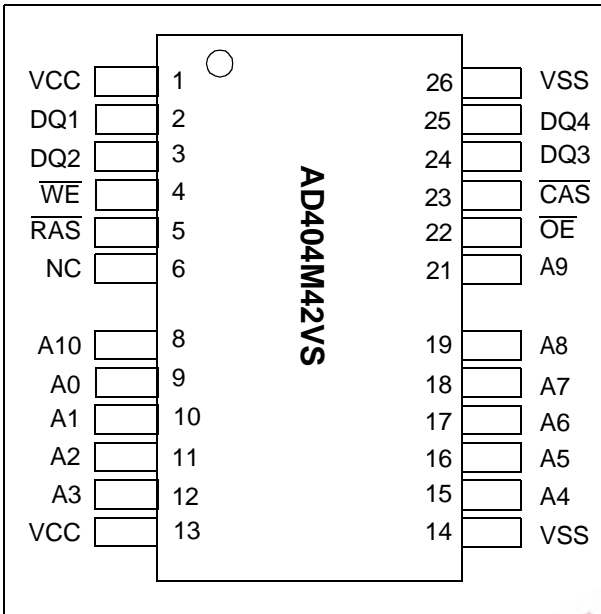

26/24-PIN 300mil Plastic TSOP (II)

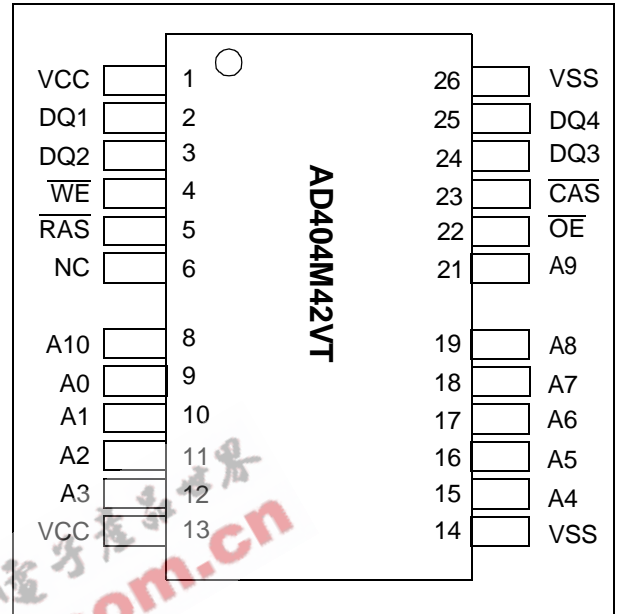

Pin Description

Pin Name	Function
A0-A10	Address inputs - Row address A0-A10 - Column address A0-A10 - Refresh address A0-A10
DQ1~DQ4	Data-in / data-out
RAS	Row address strobe
CAS	Column address strobe
WE	Write enable
OE	Output enable
Vcc	Power (+ 3.3V)
Vss	Ground

Block Diagram



TRUTH TABLE

FUNCTION		$\overline{\text{RAS}}$	$\overline{\text{CAS}}$	$\overline{\text{WE}}$	$\overline{\text{OE}}$	ADDRESSES		DQ _S	Notes
						ROW	COL		
STANDBY		H	H → X	X	X	X	X	High-Z	
READ		L	L	H	L	ROW	COL	Data-Out	
WRITE: (EARLY WRITE)		L	L	L	X	ROW	COL	Data-In	
READ WRITE		L	L	H → L	L → H	ROW	COL	Data-Out, Data-In	
EDO-PAGE-MODE READ	1st Cycle	L	H → L	H	L	ROW	COL	Data-Out	
	2nd Cycle	L	H → L	H	L	n/a	COL	Data-Out	
EDO-PAGE MODE WRITE	1st Cycle	L	H → L	L	X	ROW	COL	Data-In	
	2nd Cycle	L	H → L	L	X	n/a	COL	Data-In	
EDO-PAGE-MODE READ-WRITE	1st Cycle	L	H → L	H → L	L → H	ROW	COL	Data-Out, Data-In	
	2nd Cycle	L	H → L	H → L	L → H	n/a	COL	Data-Out, Data-In	
HIDDEN REFRESH	READ	L → H → L	L	H	L	ROW	COL	Data-Out	
	WRITE	L → H → L	L	L	X	ROW	COL	Data-In	1
RAS-ONLY REFRESH		L	H	X	X	ROW	n/a	High-Z	
CBR REFRESH		H → L	L	H	X	X	X	High-Z	

Notes: 1. EARLY WRITE only.

Absolute Maximum Ratings

Parameter	Symbol	Value	Unit
Voltage on any pin relative to V _{SS}	V _T	-0.5 to + 4.6	V
Supply voltage relative to V _{SS}	V _{CC}	-0.5 to + 4.6	V
Short circuit output current	I _{OUT}	50	mA
Power dissipation	P _D	1.0	W
Operating temperature	T _{OPT}	0 to + 70	°C
Storage temperature	T _{STG}	-55 to + 125	°C

Recommended DC Operating Conditions

Parameter/Condition	Symbol	3.3 Volt Version			Unit
		Min	Typ	Max	
Supply Voltage	V _{CC}	3.0	3.3	3.6	V
Input High Voltage, all inputs	V _{IH}	2.0	-	V _{CC} + 0.3	V
Input Low Voltage, all inputs	V _{IL}	-0.3	-	-0.8	V

Capacitance

T_a = 25°C, V_{CC} = 3.3V ±10 %, f = 1MHz

Parameter	Symbol	Typ	Max	Unit	Note
Input capacitance (Address)	C _{I1}	-	5	pF	1
Input capacitance ($\overline{\text{RAS}}$, $\overline{\text{CAS}}$, $\overline{\text{OE}}$, $\overline{\text{WE}}$)	C _{I2}	-	7	pF	1
Output capacitance (Data-in, Data-out)	C _{I/O}	-	7	pF	1, 2

Note: 1. Capacitance measured with effective capacitance measuring method.

2. RAS, CAS = V_{IH} to disable Dout.

DC Characteristics :

($T_a = 0$ to 70°C , $V_{CC} = + 3.3\text{V} \pm 10\%$, $V_{SS} = 0\text{V}$)

Parameter		Symbol	Test Conditions	AD404M42V				Unit	Notes
				-5		-6			
				Min	Max	Min	Max		
Operating current		I_{CC1}	$\overline{\text{RAS}}$ cycling CAS, cycling $t_{RC} = \text{min}$	-	120	-	110	mA	1, 2
Standby Current	Low power S-version	I_{CC2}	LVTTTL interface RAS, CAS = V_{IH} Dout = High-Z	-	0.5	-	0.5	mA	
			CMOS interface $\overline{\text{RAS}}, \overline{\text{CAS}} \geq V_{CC} - 0.2\text{V}$ Dout = High-Z	-	0.15	-	0.15	mA	
	Standard power version	I_{CC2}	LVTTTL interface RAS, CAS = V_{IH} Dout = High-Z	-	2	-	2	mA	
			CMOS interface $\overline{\text{RAS}}, \overline{\text{CAS}} \geq V_{CC} - 0.2\text{V}$ Dout = High-Z	-	0.5	-	0.5	mA	
RAS- only refresh current		I_{CC3}	$\overline{\text{RAS}}$ cycling, $\overline{\text{CAS}} = V_{IH}$ $t_{RC} = \text{min}$	-	120	-	110	mA	1, 2
EDO page mode current		I_{CC4}	$t_{PC} = \text{min}$	-	90	-	80	mA	1, 3
CAS- before- RAS refresh current		I_{CC5}	$t_{RC} = \text{min}$ RAS, CAS cycling	-	120	-	110	mA	1, 2
Self- refresh current (S-Version)		I_{CC8}	$t_{RASS} \geq 100\mu\text{s}$	-	550	-	550	μA	

DC Characteristics :(T_a = 0 to 70°C, V_{CC} = +3.3V ±10%, V_{SS} = 0V)

Parameter	Symbol	Test Conditions	AD404M42V				Unit	Notes
			-5		-6			
			Min	Max	Min	Max		
Input leakage current	I _{LI}	0V ≤ V _{in} ≤ V _{CC} + 0.3V	-5	5	-5	5	μA	
Output leakage current	I _{LO}	0V ≤ V _{out} ≤ V _{CC} + 0.3V Dout = Disable	-5	5	-5	5	μA	
Output high Voltage	V _{OH}	I _{OH} = -2mA	2.4	-	2.4	-	V	
Output low voltage	V _{OL}	I _{OL} = +2mA	-	0.4	-	0.4	V	

Notes:

1. I_{CC} is specified as an average current. It depends on output loading condition and cycle rate when the device is selected. I_{CC} max is specified at the output open condition.
2. Address can be changed once or less while $\overline{\text{RAS}} = V_{\text{IL}}$.
3. For I_{CC4}, address can be changed once or less within one EDO page mode cycle time.

AC Characteristics

($T_a = 0$ to $+70^\circ\text{C}$, $V_{CC} = 3.3\text{V} \pm 10\%$, $V_{SS} = 0\text{V}$) *1, *2, *3, *4

Test conditions

- Output load: one TTL Load and 100pF ($V_{CC} = 3.3\text{V} \pm 10\%$)
- Input timing reference levels:
 $V_{IH} = 2.0\text{V}$, $V_{IL} = 0.8\text{V}$ ($V_{CC} = 3.3\text{V} \pm 10\%$)
- Output timing reference levels:
 $V_{OH} = 2.0\text{V}$, $V_{OL} = 0.8\text{V}$

Read, Write, Read- Modify- Write and Refresh Cycles

(Common Parameters)

Parameter	Symbol	AD404M42V				Unit	Notes
		-5		-6			
		Min	Max	Min	Max		
Random read or write cycle time	t_{RC}	84	-	104	-	ns	
$\overline{\text{RAS}}$ precharge time	t_{RP}	30	-	40	-	ns	
$\overline{\text{CAS}}$ precharge time in normal mode	t_{CPN}	10	-	10	-	ns	
$\overline{\text{RAS}}$ pulse width	t_{RAS}	50	10000	60	10000	ns	5
$\overline{\text{CAS}}$ pulse width	t_{CAS}	8	10000	10	10000	ns	6
Row address setup time	t_{ASR}	0	-	0	-	ns	
Row address hold time	t_{RAH}	8	-	10	-	ns	
Column address setup time	t_{ASC}	0	-	0	-	ns	7
Column address hold time	t_{CAH}	8	-	10	-	ns	
$\overline{\text{RAS}}$ to $\overline{\text{CAS}}$ delay time	t_{RCD}	12	37	14	45	ns	8
$\overline{\text{RAS}}$ to column address delay time	t_{RAD}	10	25	12	30	ns	9
Column address to $\overline{\text{RAS}}$ lead time	t_{RAL}	25	-	30	-	ns	
$\overline{\text{RAS}}$ hold time	t_{RSH}	8	-	10	-	ns	
$\overline{\text{CAS}}$ hold time	t_{CSH}	38	-	40	-	ns	
$\overline{\text{CAS}}$ to $\overline{\text{RAS}}$ precharge time	t_{CRP}	5	-	5	-	ns	10
$\overline{\text{OE}}$ to Din delay time	t_{OED}	12	-	15	-	ns	
Transition time (rise and fall)	t_T	1	50	1	50	ns	11
Refresh period	t_{REF}	-	32	-	32	ms	
Refresh period (S- Version)	t_{REF}	-	128	-	128	ms	
$\overline{\text{CAS}}$ to output in Low- Z	t_{CLZ}	0	-	0	-	ns	
$\overline{\text{CAS}}$ delay time from Din	t_{DZC}	0	-	0	-	ns	
$\overline{\text{OE}}$ delay time from Din	t_{DZO}	0	-	0	-	ns	

Read Cycle

Parameter	Symbol	AD404M42V				Unit	Notes
		-5		-6			
		Min	Max	Min	Max		
Access time from $\overline{\text{RAS}}$	t_{RAC}	-	50	-	60	ns	12
Access time from $\overline{\text{CAS}}$	t_{CAC}	-	14	-	15	ns	13, 14
Access time from column address	t_{AA}	-	25	-	30	ns	14, 15
Access time from $\overline{\text{OE}}$	t_{OEA}	-	12	-	15	ns	
Read command setup time	t_{RCS}	0	-	0	-	ns	7
Read command hold time to $\overline{\text{CAS}}$	t_{RCH}	0	-	0	-	ns	10, 16
Read command hold time to $\overline{\text{RAS}}$	t_{RRH}	0	-	0	-	ns	16
Output buffer turn-off time	t_{OFF}	0	12	0	15	ns	17
Output buffer turn-off time from $\overline{\text{OE}}$	t_{OEZ}	0	12	0	15	ns	17

Write Cycle

Parameter	Symbol	AD404M42V				Unit	Notes
		-5		-6			
		Min	Max	Min	Max		
Write command setup time	t_{WCS}	0	-	0	-	ns	7, 18
Write command hold time	t_{WCH}	8	-	10	-	ns	
Write command pulse width	t_{WP}	8	-	10	-	ns	
Write command to $\overline{\text{RAS}}$ lead time	t_{RWL}	13	-	15	-	ns	
Write command to $\overline{\text{CAS}}$ lead time	t_{CWL}	8	-	10	-	ns	
Data-in setup time	t_{DS}	0	-	0	-	ns	19
Data-in hold time	t_{DH}	8	-	10	-	ns	19
$\overline{\text{WE}}$ to Data-in delay	t_{WED}	10	-	10	-	ns	

Read- Modify- Write Cycle

Parameter	Symbol	AD404M42V				Unit	Notes
		-5		-6			
		Min	Max	Min	Max		
Read-modify- write cycle time	t_{RWC}	108	-	133	-	ns	
\overline{RAS} to \overline{WE} delay time	t_{RWD}	64	-	77	-	ns	18
\overline{CAS} to \overline{WE} dealy time	t_{CWD}	26	-	32	-	ns	18
Column address to \overline{WE} delay time	t_{AWD}	39	-	47	-	ns	18
\overline{OE} hold time from \overline{WE}	t_{OEH}	8	-	10	-	ns	

Refresh Cycle

Parameter	Symbol	AD404M42V				Unit	Notes
		-5		-6			
		Min	Max	Min	Max		
\overline{CAS} setup time (CBR refresh)	t_{CSR}	5	-	5	-	ns	
\overline{CAS} hold time (CBR refresh)	t_{CHR}	8	-	10	-	ns	10
\overline{RAS} precharge to \overline{CAS} hold time	t_{RPC}	5	-	5	-	ns	7
\overline{RAS} pulse width (self refresh)	t_{RASS}	100	-	100	-	μs	
\overline{RAS} precharge time (self refresh)	t_{RPS}	90	-	110	-	ns	
\overline{CAS} hold time (CBR self refresh)	t_{CHS}	-50	-	-50	-	ns	
\overline{WE} setup time	t_{WSR}	0	-	0	-	ns	
\overline{WE} hold time	t_{WHR}	10	-	10	-	ns	

EDO Page Mode Cycle

Parameter	Symbol	AD404M42V				Unit	Notes
		-5		-6			
		Min	Max	Min	Max		
EDO page mode cycle time	t_{PC}	20	-	25	-	ns	
EDO page mode \overline{CAS} precharge time	t_{CP}	10	-	10	-	ns	
EDO page mode \overline{RAS} pulse width	t_{RASP}	50	10^5	60	10^5	ns	20
Access time from \overline{CAS} precharge	t_{CPA}	-	30	-	35	ns	10, 14
\overline{RAS} hold time from \overline{CAS} precharge	t_{CPRH}	30	-	35	-	ns	
\overline{OE} high hold time from \overline{CAS} high	t_{OEHC}	5	-	5	-	ns	
\overline{OE} high pulse width	t_{OEP}	10	-	10	-	ns	
Data output hold time after \overline{CAS} low	t_{COH}	5	-	5	-	ns	
Output disable delay from \overline{WE}	t_{WHZ}	3	10	3	10	ns	
\overline{WE} pulse width for output disable when \overline{CAS} high	t_{WPZ}	7	-	7	-	ns	

EDO Page Mode Read Modify Write Cycle

Parameter	Symbol	AD404M42V				Unit	Notes
		-5		-6			
		Min	Max	Min	Max		
EDO page mode read- modify- write cycle \overline{CAS} precharge to \overline{WE} delay time	t_{CPW}	45	-	55	-	ns	10
EDO page mode read- modify- write cycle time	t_{PRWC}	56	-	68	-	ns	

Notes :

1. AC measurements assume $t_T = 2\text{ns}$.
2. An initial pause of $100\ \mu\text{s}$ is required after power up, and it followed by a minimum of eight initialization cycles ($\overline{\text{RAS}}$ - only refresh cycle or $\overline{\text{CAS}}$ - before - $\overline{\text{RAS}}$ refresh cycle). If the internal refresh counter is used, a minimum of eight $\overline{\text{CAS}}$ - before - $\overline{\text{RAS}}$ refresh cycles are required.
3. In delayed write or read-modify-write cycles, $\overline{\text{OE}}$ must disable output buffer prior to applying data to the device.
4. All the V_{CC} and V_{SS} pins shall be supplied with the same voltages.
5. $t_{\text{RAS}}(\text{min}) = t_{\text{RWD}}(\text{min}) + t_{\text{RWL}}(\text{min}) + t_T$ in read-modify-write cycle.
6. $t_{\text{CAS}}(\text{min}) = t_{\text{CWD}}(\text{min}) + t_{\text{CWL}}(\text{min}) + t_T$ in read-modify-write cycle.
7. $t_{\text{ASC}}(\text{min})$, $t_{\text{RCS}}(\text{min})$, $t_{\text{WCS}}(\text{min})$, and t_{RPC} are determined by the falling edge of $\overline{\text{CAS}}$.
8. $t_{\text{RCD}}(\text{max})$ is specified as a reference point only, and $t_{\text{RAC}}(\text{max})$ can be met with the $t_{\text{RCD}}(\text{max})$ limit. Otherwise, t_{RAC} is controlled exclusively by t_{CAC} if t_{RCD} is greater than the specified $t_{\text{RCD}}(\text{max})$ limit.
9. $t_{\text{RAD}}(\text{max})$ is specified as a reference point only, and $t_{\text{RAC}}(\text{max})$ can be met with the $t_{\text{RAD}}(\text{max})$ limit. Otherwise, t_{RAC} is controlled exclusively by t_{AA} if t_{RAD} is greater than the specified $t_{\text{RAD}}(\text{max})$ limit.
10. t_{CRP} , t_{CHR} , t_{RCH} , t_{CPA} and t_{CPW} are determined by the rising edge of $\overline{\text{CAS}}$.
11. $V_{\text{IH}}(\text{min})$ and $V_{\text{IL}}(\text{max})$ are reference levels for measuring timing or input signals. Therefore, transition time is measured between V_{IH} and V_{IL} .
12. Assumes that $t_{\text{RCD}} \leq t_{\text{RCD}}(\text{max})$ and $t_{\text{RAD}} \leq t_{\text{RAD}}(\text{max})$. If t_{RCD} or t_{RAD} is greater than the maximum recommended value shown in this table, t_{RAC} exceeds the value shown.
13. Assumes that $t_{\text{RCD}} \geq t_{\text{RCD}}(\text{max})$ and $t_{\text{RAD}} \leq t_{\text{RAD}}(\text{max})$.
14. Access time is determined by the maximum of t_{AA} , t_{CAC} , t_{CPA} .
15. Assumes that $t_{\text{RCD}} \leq t_{\text{RCD}}(\text{max})$ and $t_{\text{RAD}} \geq t_{\text{RAD}}(\text{max})$.
16. Either t_{RCH} or t_{RRH} must be satisfied for a read cycle.
17. $t_{\text{OFF}}(\text{max})$ and $t_{\text{OEZ}}(\text{max})$ define the time at which the output achieves the open circuit condition (high impedance). t_{OFF} is determined by the later rising edge of $\overline{\text{RAS}}$ or $\overline{\text{CAS}}$.
18. t_{WCS} , t_{RWD} , t_{CWD} , and t_{AWD} are not restrictive operating parameters. They are included in the data sheet as electrical characteristics only. If $t_{\text{WCS}} \geq t_{\text{WCS}}(\text{min})$, the cycle is an early write cycle and the data out will remain open circuit (high impedance) throughout the entire cycle. If $t_{\text{RWD}} \geq t_{\text{RWD}}(\text{min})$, $t_{\text{CWD}} \geq t_{\text{CWD}}(\text{min})$, $t_{\text{AWD}} \geq t_{\text{AWD}}(\text{min})$ and $t_{\text{CPW}} \geq t_{\text{CPW}}(\text{min})$, the cycle is a read-modify-write and the data output will contain data read from the selected cell. If neither of the above sets of conditions is satisfied, the condition of the data output (at access time) is indeterminate.
19. These parameters are referenced to $\overline{\text{CAS}}$ separately in an early write cycle and to $\overline{\text{WE}}$ edge in a delayed write or a read-modify-write cycle.
20. t_{RASP} defines $\overline{\text{RAS}}$ pulse width in EDO page mode cycles.

Timing Waveforms
• Read Cycle



•Early Write Cycle



• Delayed Write Cycle



• Read - Modify - Write Cycle



• EDO Page Mode Read Cycle

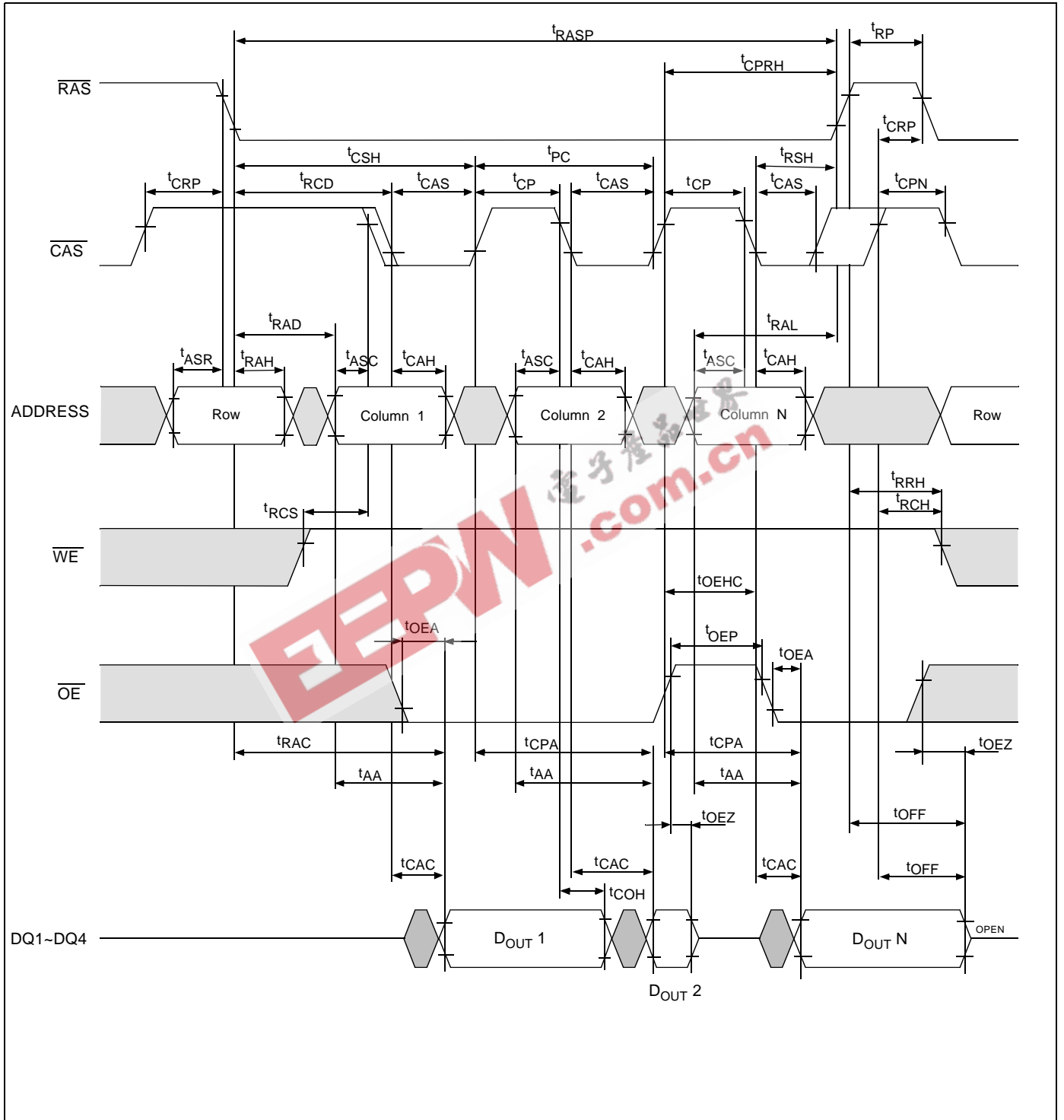

• EDO Page Mode Early Write Cycle



• EDO Page Mode Read-Early-Write Cycle



• EDO Page Mode Read-Modify-Write Cycle



• Read Cycle with $\overline{\text{WE}}$ Controlled Disable

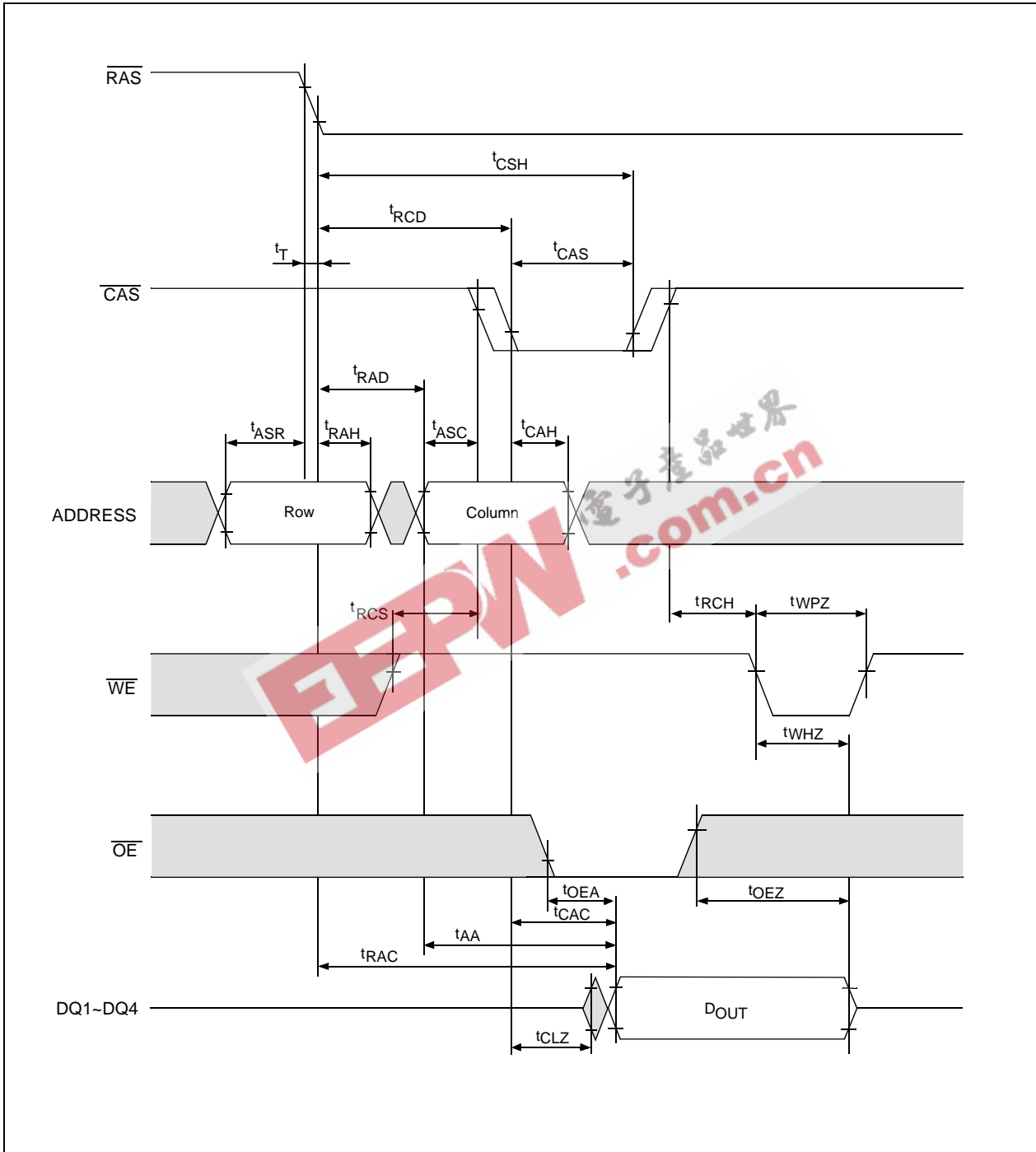

RAS-Only Refresh Cycle

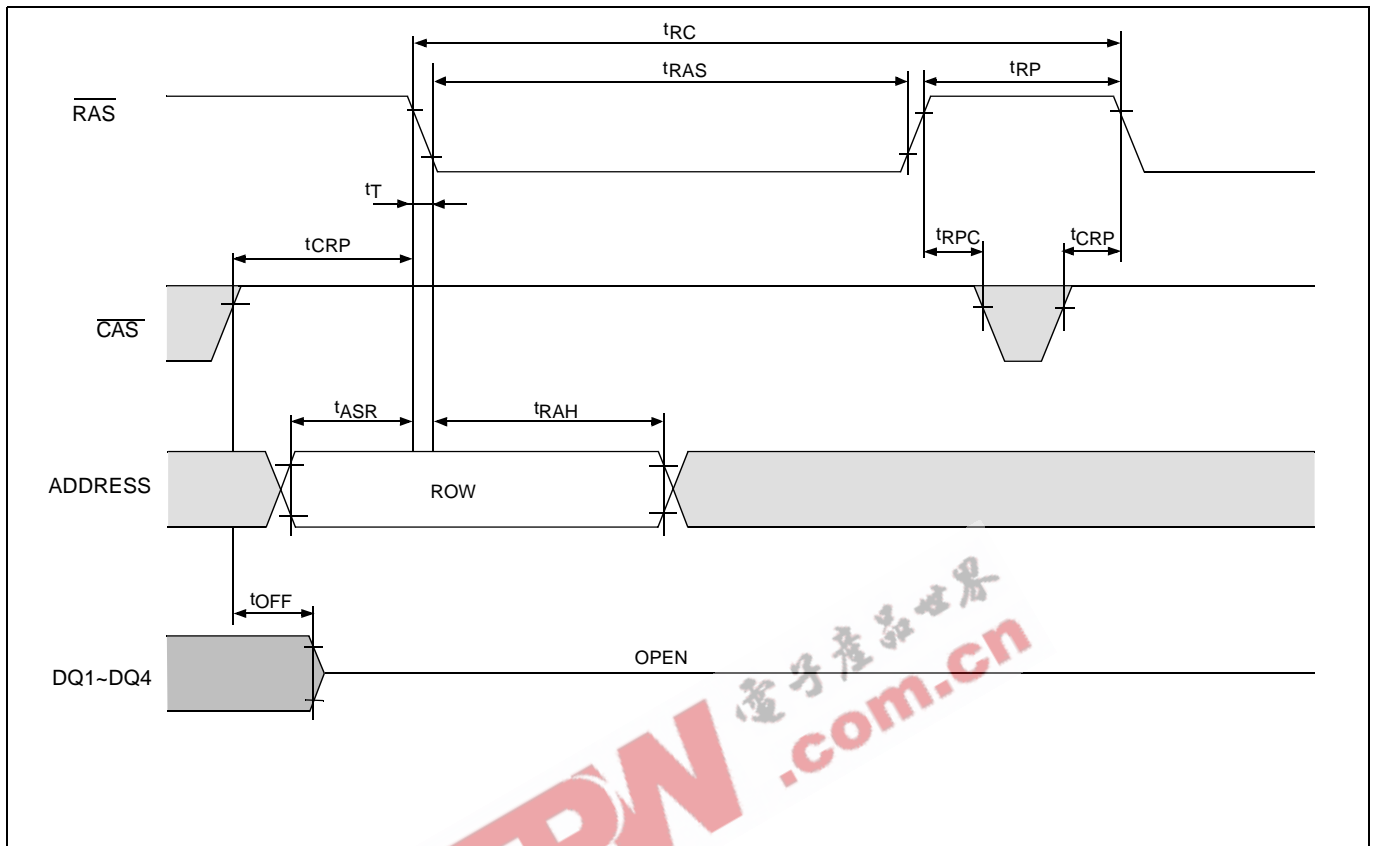

CAS-Before-RAS Refresh Cycle

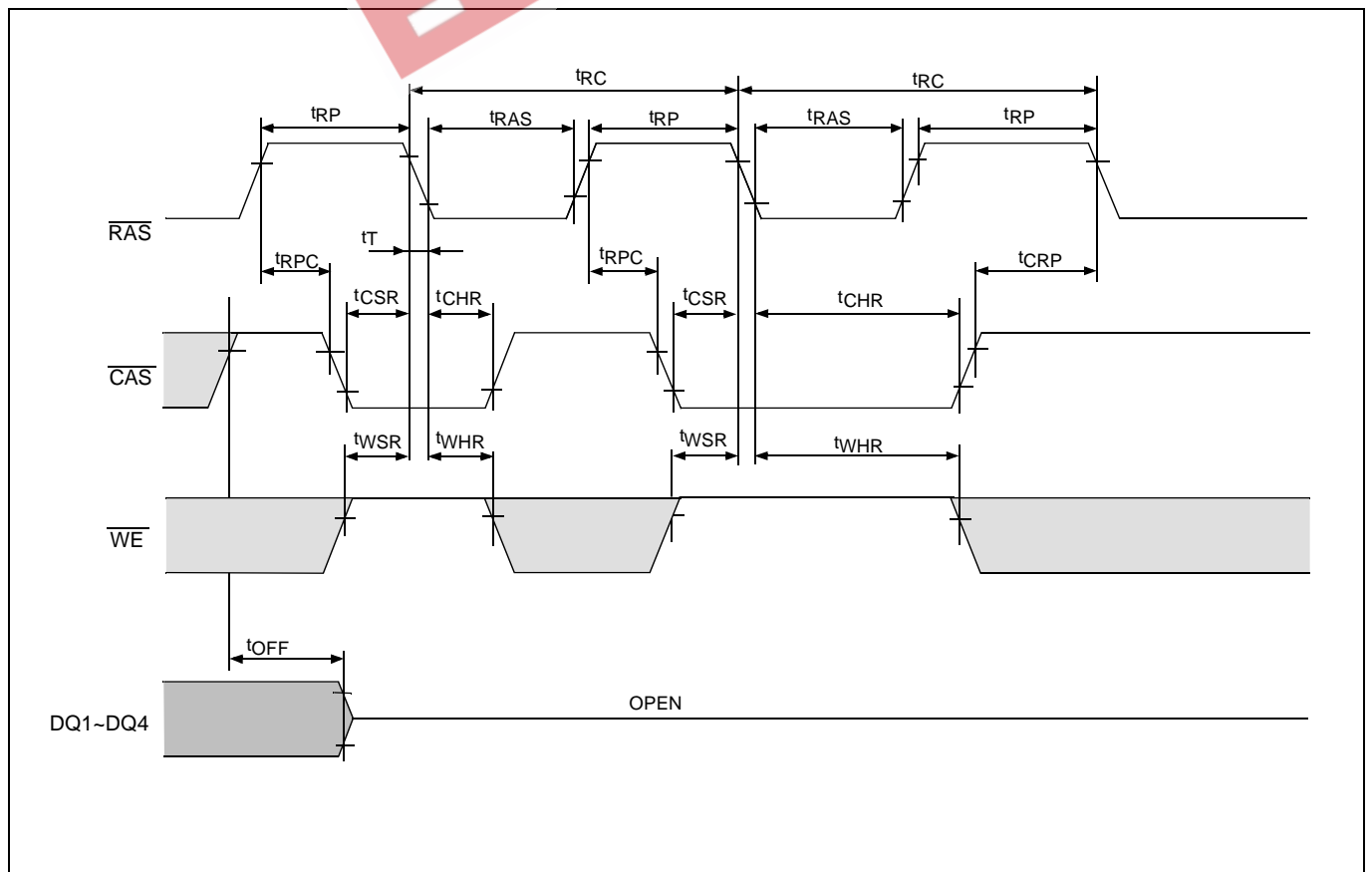

CBR Self-Refresh Cycle

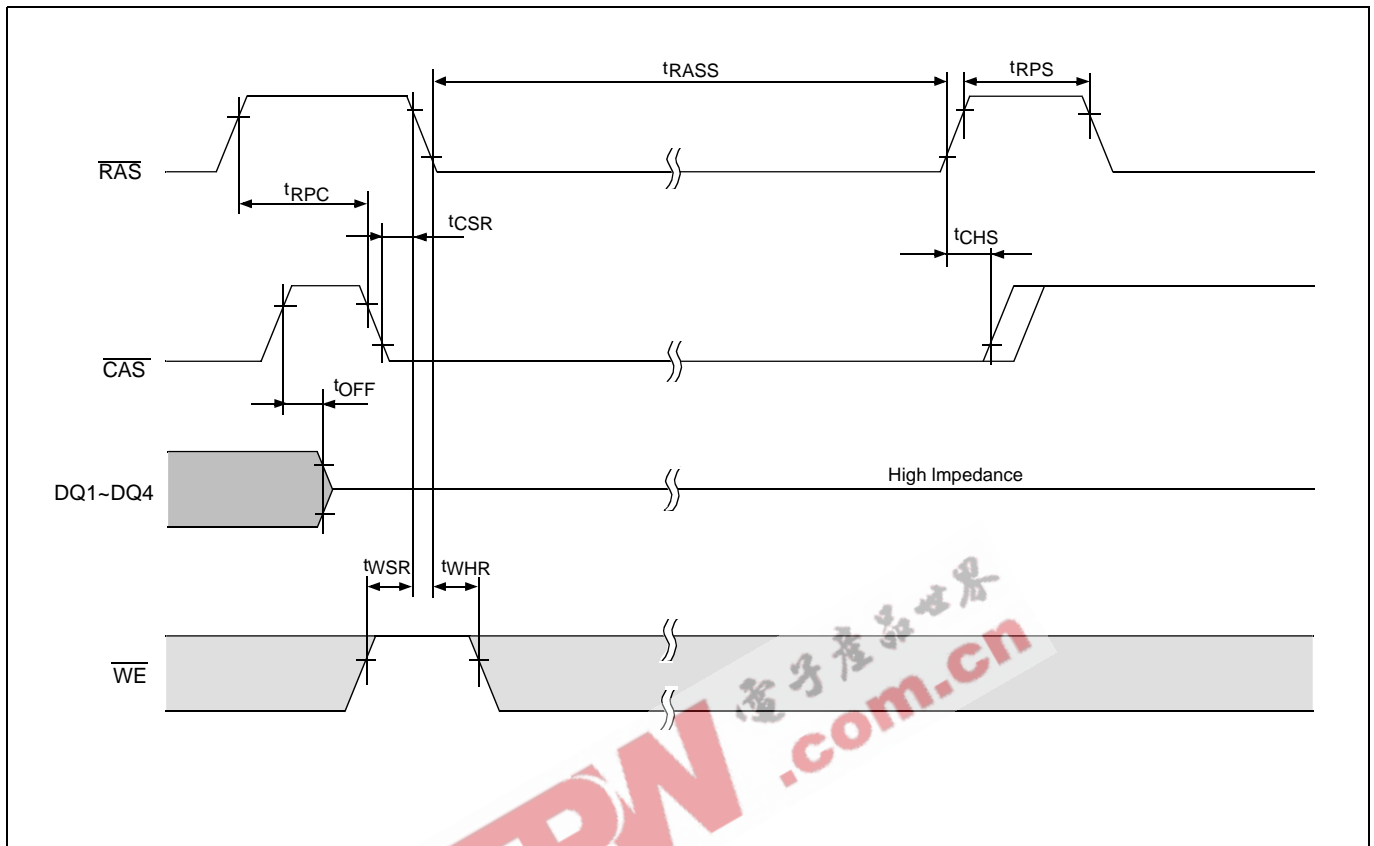

• Hidden Refresh Cycle



Ordering information

Part Number	Access time	Package
AD404M42VSA-5	50 ns	300mil 26/24-Pin
AD404M42VSA-6	60 ns	
AD404M42VTA-5	50 ns	Plastic SOJ TSOP II
AD404M42VTA-6	60 ns	

AD404M42VSA-5

- AD → • Ascend Memory Product
- 40 → • Device Type
- 4M4 → • Density and Organization
- 2 → • Refresh Rate, 2: 2K Refresh
- V → • T: 5V, V: 3.3V
- S → • Package Type (S : SOJ, T : TSOP II)
- A → • Version
- 5 → • Speed (5: 50 ns, 6: 60 ns)

Packaging information

- 300 mil, 26/24-Pin Plastic SOJ



• 300 mil, 26/24-Pin TSOP II

DIM	MILLIMETERS			INCHES		
	MIN.	NOM.	MAX.	MIN.	NOM.	MAX.
A	---	---	1.20	---	---	0.047
A1	0.05	---	0.15	0.002	---	0.006
A2	0.95	1.00	1.05	0.037	0.039	0.041
b	0.30	---	0.52	0.012	---	0.020
b1	0.30	0.40	0.45	0.012	0.016	0.018
c	0.12	---	0.21	0.005	---	0.008
c1	0.12	0.15	0.16	0.005	0.006	(0.006)
D	17.01	17.14	17.27	0.670	0.675	0.680
ZD	0.95 REF.			0.0374 BASIC		
e	1.27 BASIC			0.050 BASIC		
E	9.02	9.22	9.42	0.355	0.363	0.371
E1	7.49	7.62	7.75	0.295	0.300	0.305
L	0.40	0.50	0.60	0.016	0.020	0.024
R	0.12	---	0.25	0.005	---	0.010
R1	0.12	---	---	0.005	---	---



NOTE:

- CONTROLLING DIMENSION : MILLIMETERS
- DIMENSION D DOES NOT INCLUDE MOLD PROTRUSION.
MOLD PROTRUSION SHALL NOT EXCEED 0.15(0.006") PER SIDE.
DIMENSION E1 DOES NOT INCLUDE INTERLEAD PROTRUSION.
INTERLEAD PROTRUSION SHALL NOT EXCEED 0.25(0.01") PER SIDE.
- DIMENSION b DOES NOT INCLUDE DAMBAR PROTRUSIONS/INTRUSION.
ALLOWABLE DAMBAR PROTRUSION SHALL NOT CAUSE THE LEAD TO BE WIDER THAN THE MAX b DIMENSION BY MORE THAN 0.13mm.
DAMBAR INTRUSION SHALL NOT CAUSE THE LEAD TO BE NARROWER THAN THE MIN b DIMENSION BY MORE THAN 0.07mm.

