



# Low Cost, 300 MHz Voltage Feedback Amplifiers

## AD8055/AD8056

### FEATURES

Low Cost Single (AD8055) and Dual (AD8056)  
Easy to Use Voltage Feedback Architecture  
High Speed

- 300 MHz, -3 dB Bandwidth ( $G = +1$ )
- 1400 V/ $\mu$ s Slew Rate
- 20 ns Settling to 0.1%
- Low Distortion: -72 dBc @ 10 MHz
- Low Noise: 6 nV/ $\sqrt{\text{Hz}}$
- Low DC Errors: 5 mV Max  $V_{OS}$ , 1.2  $\mu$ A Max  $I_B$

### Small Packaging

- AD8055 Available in SOT-23-5
- AD8056 Available in 8-Lead microSOIC

### Excellent Video Specifications ( $R_L = 150 \Omega$ , $G = +2$ )

- Gain Flatness 0.1 dB to 40 MHz
- 0.01% Differential Gain Error
- 0.02° Differential Phase Error
- Drives Four Video Loads (37.5  $\Omega$ ) with 0.02% and 0.1° Differential Gain and Differential Phase

### Low Power, $\pm 5$ V Supplies

- 5 mA Typ/Amplifier Power Supply Current
- High Output Drive Current: Over 60 mA

### APPLICATIONS

- Imaging
- Photodiode Preamp
- Video Line Driver
- Differential Line Driver
- Professional Cameras
- Video Switchers
- Special Effects
- A-to-D Driver
- Active Filters

### PRODUCT DESCRIPTION

The AD8055 (single) and AD8056 (dual) voltage feedback amplifiers offer bandwidth and slew rate typically found in current feedback amplifiers. Additionally, these amplifiers are easy to use and available at a very low cost.

Despite their low cost, the AD8055 and AD8056 provide excellent overall performance. For video applications, their differential gain and phase error are 0.01% and 0.02° into a 150  $\Omega$  load, and 0.02% and 0.1° while driving four video loads (37.5  $\Omega$ ). Their 0.1 dB flatness out to 40 MHz, wide bandwidth out to 300 MHz, along with 1400 V/ $\mu$ s slew rate and 20 ns settling time, make them useful for a variety of high speed applications.

### FUNCTIONAL BLOCK DIAGRAMS

#### N-8 and SO-8

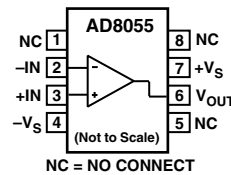

#### SOT-23-5 (RT)

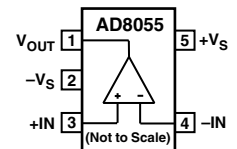

#### N-8, SO-8, microSOIC (RM)

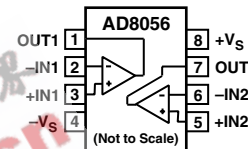

The AD8055 and AD8056 require only 5 mA typ/amplifier of supply current and operate on dual  $\pm 5$  V or single +12 V power supply, while being capable of delivering over 60 mA of load current. All this is offered in a small 8-lead plastic DIP, 8-lead SOIC packages, 5-lead SOT-23-5 package (AD8055) and an 8-lead microSOIC package (AD8056). These features make the AD8055/AD8056 ideal for portable and battery powered applications where size and power are critical. These amplifiers are available in the industrial temperature range of -40°C to +85°C.

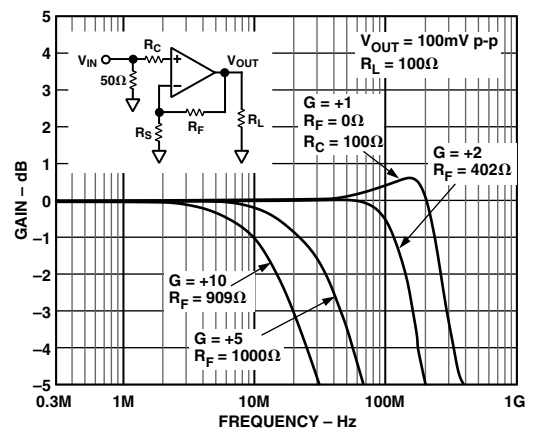

Figure 1. Frequency Response

### REV. B

Information furnished by Analog Devices is believed to be accurate and reliable. However, no responsibility is assumed by Analog Devices for its use, nor for any infringements of patents or other rights of third parties which may result from its use. No license is granted by implication or otherwise under any patent or patent rights of Analog Devices.

# AD8055/AD8056—SPECIFICATIONS (@ T<sub>A</sub> = +25°C, V<sub>S</sub> = 65 V, R<sub>F</sub> = 402 Ω, R<sub>L</sub> = 100 Ω, Gain = +2, unless otherwise noted)

Model	Conditions	AD8055A/AD8056A			Unit
		Min	Typ	Max	
<b>DYNAMIC PERFORMANCE</b>					
-3 dB Bandwidth	G = +1, V <sub>O</sub> = 0.1 V p-p	220	300		MHz
	G = +1, V <sub>O</sub> = 2 V p-p	125	150		MHz
	G = +2, V <sub>O</sub> = 0.1 V p-p	120	160		MHz
	G = +2, V <sub>O</sub> = 2 V p-p	125	150		MHz
Bandwidth for 0.1 dB Flatness	V <sub>O</sub> = 100 mV p-p	25	40		MHz
Slew Rate	G = +1, V <sub>O</sub> = 4 V Step	1000	1400		V/μs
	G = +2, V <sub>O</sub> = 4 V Step	750	840		V/μs
Settling Time to 0.1%	G = +2, V <sub>O</sub> = 2 V Step		20		ns
Rise and Fall Time, 10% to 90%	G = +1, V <sub>O</sub> = 0.5 V Step		2		ns
	G = +1, V <sub>O</sub> = 4 V Step		2.7		ns
	G = +2, V <sub>O</sub> = 0.5 V Step		2.8		ns
	G = +2, V <sub>O</sub> = 4 V Step		4		ns
<b>NOISE/HARMONIC PERFORMANCE</b>					
Total Harmonic Distortion	f <sub>C</sub> = 10 MHz, V <sub>O</sub> = 2 V p-p, R <sub>L</sub> = 1 kΩ		-72		dBc
	f <sub>C</sub> = 20 MHz, V <sub>O</sub> = 2 V p-p, R <sub>L</sub> = 1 kΩ		-57		dBc
Crosstalk, Output to Output (AD8056)	f = 5 MHz, G = +2		-60		dB
Input Voltage Noise	f = 100 kHz		6		nV/√Hz
Input Current Noise	f = 100 kHz		1		pA/√Hz
Differential Gain Error	NTSC, G = +2, R <sub>L</sub> = 150 Ω		0.01		%
	R <sub>L</sub> = 37.5 Ω		0.02		%
Differential Phase Error	NTSC, G = +2, R <sub>L</sub> = 150 Ω		0.02		Degree
	R <sub>L</sub> = 37.5 Ω		0.1		Degree
<b>DC PERFORMANCE</b>					
Input Offset Voltage			3	5	mV
Offset Drift	T <sub>MIN</sub> -T <sub>MAX</sub>			10	mV
Input Bias Current			6		μV/°C
			0.4	1.2	μA
Open Loop Gain	T <sub>MIN</sub> -T <sub>MAX</sub>		1		μA
	V <sub>O</sub> = ±2.5 V	66	71		dB
	T <sub>MIN</sub> -T <sub>MAX</sub>	64			dB
<b>INPUT CHARACTERISTICS</b>					
Input Resistance			10		MΩ
Input Capacitance			2		pF
Input Common-Mode Voltage Range			3.2		±V
Common-Mode Rejection Ratio	V <sub>CM</sub> = ±2.5 V		82		dB
<b>OUTPUT CHARACTERISTICS</b>					
Output Voltage Swing	R <sub>L</sub> = 150 Ω	2.9	3.1		±V
Output Current <sup>1</sup>	V <sub>O</sub> = ±2.0 V	55	60		mA
Short Circuit Current <sup>1</sup>			110		mA
<b>POWER SUPPLY</b>					
Operating Range		±4.0	±5.0	±6.0	V
Quiescent Current	AD8055		5.4	6.5	mA
	T <sub>MIN</sub> -T <sub>MAX</sub>			7.3	mA
	AD8056		10	12	mA
	T <sub>MIN</sub> -T <sub>MAX</sub>			13.3	mA
Power Supply Rejection Ratio	+V <sub>S</sub> = +5 V to +6 V, -V <sub>S</sub> = -5 V	66	72		dB
	-V <sub>S</sub> = -5 V to -6 V, +V <sub>S</sub> = +5 V	69	86		dB
<b>OPERATING TEMPERATURE RANGE</b>					
		-40		+85	°C

## NOTES

<sup>1</sup>Output current is limited by the maximum power dissipation in the package. See the power derating curves.

Specifications subject to change without notice.

# AD8055/AD8056

## ABSOLUTE MAXIMUM RATINGS<sup>1</sup>

Supply Voltage	13.2 V
Internal Power Dissipation <sup>2</sup>	
Plastic DIP Package (N)	1.3 W
Small Outline Package (R)	0.8 W
SOT-23-5 Package (RT)	0.5 W
microSOIC Package (RM)	0.6 W
Input Voltage (Common Mode)	$\pm V_S$
Differential Input Voltage	$\pm 2.5 V$
Output Short Circuit Duration	Observe Power Derating Curves
Storage Temperature Range N, R	-65°C to +125°C
Operating Temperature Range (A Grade)	-40°C to +85°C
Lead Temperature Range (Soldering 10 sec)	+300°C

## NOTES

<sup>1</sup>Stresses above those listed under Absolute Maximum Ratings may cause permanent damage to the device. This is a stress rating only; functional operation of the device at these or any other conditions above those indicated in the operational section of this specification is not implied. Exposure to absolute maximum rating conditions for extended periods may affect device reliability.

<sup>2</sup>Specification is for device in free air:

- 8-Lead Plastic DIP Package:  $\theta_{JA} = 90^\circ\text{C/W}$
- 8-Lead SOIC Package:  $\theta_{JA} = 155^\circ\text{C/W}$
- 5-Lead SOT-23-5 Package:  $\theta_{JA} = 240^\circ\text{C/W}$
- 8-Lead microSOIC Package:  $\theta_{JA} = 200^\circ\text{C/W}$

## MAXIMUM POWER DISSIPATION

The maximum power that can be safely dissipated by the AD8055/AD8056 is limited by the associated rise in junction temperature. The maximum safe junction temperature for plastic encapsulated devices is determined by the glass transition temperature

of the plastic, approximately +150°C. Exceeding this limit temporarily may cause a shift in parametric performance due to a change in the stresses exerted on the die by the package. Exceeding a junction temperature of +175°C for an extended period can result in device failure.

While the AD8055/AD8056 are internally short circuit protected, this may not be sufficient to guarantee that the maximum junction temperature (+150°C) is not exceeded under all conditions. To ensure proper operation, it is necessary to observe the maximum power derating curves.

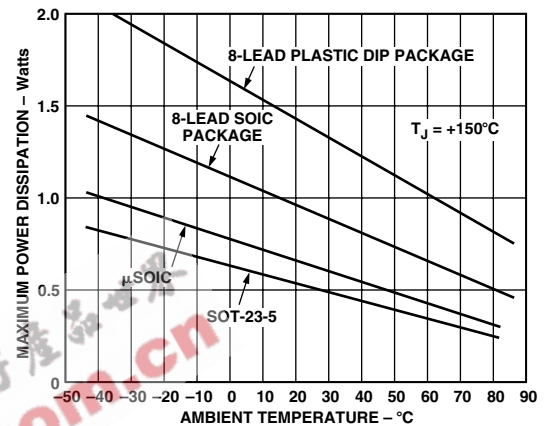

Figure 2. Plot of Maximum Power Dissipation vs. Temperature for AD8055/AD8056

## ORDERING GUIDE

Model	Temperature Range	Package Description	Package Option	Brand Code
AD8055AN	-40°C to +85°C	Plastic DIP	N-8	
AD8055AR	-40°C to +85°C	Small Outline Package (SOIC)	SO-8	
AD8055AR-REEL	-40°C to +85°C	13" Tape and Reel	SO-8	
AD8055AR-REEL7	-40°C to +85°C	7" Tape and Reel	SO-8	
AD8055ART-REEL	-40°C to +85°C	13" Tape and Reel	RT-5	H3A
AD8055ART-REEL7	-40°C to +85°C	7" Tape and Reel	RT-5	H3A
AD8056AN	-40°C to +85°C	Plastic DIP	N-8	
AD8056AR	-40°C to +85°C	Small Outline Package (SOIC)	SO-8	
AD8056AR-REEL	-40°C to +85°C	13" Tape and Reel	SO-8	
AD8056AR-REEL7	-40°C to +85°C	7" Tape and Reel	SO-8	
AD8056ARM	-40°C to +85°C	microSOIC	RM-8	H5A
AD8056ARM-REEL	-40°C to +85°C	13" Tape and Reel	RM-8	H5A
AD8056ARM-REEL7	-40°C to +85°C	7" Tape and Reel	RM-8	H5A

## CAUTION

ESD (electrostatic discharge) sensitive device. Electrostatic charges as high as 4000 V readily accumulate on the human body and test equipment and can discharge without detection. Although the AD8055/AD8056 features proprietary ESD protection circuitry, permanent damage may occur on devices subjected to high-energy electrostatic discharges. Therefore, proper ESD precautions are recommended to avoid performance degradation or loss of functionality.



# AD8055/AD8056—Typical Performance Characteristics

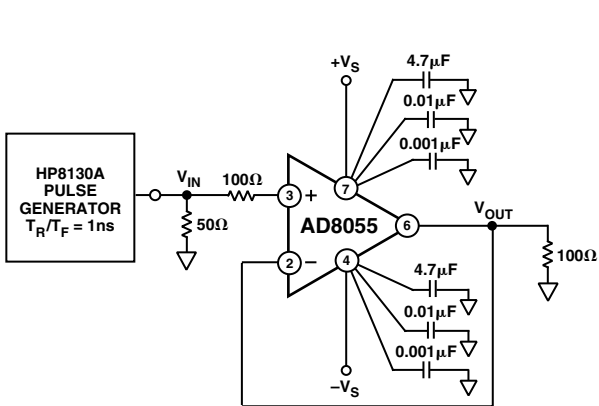

Figure 3. Test Circuit,  $G = +1$ ,  $R_L = 100\ \Omega$

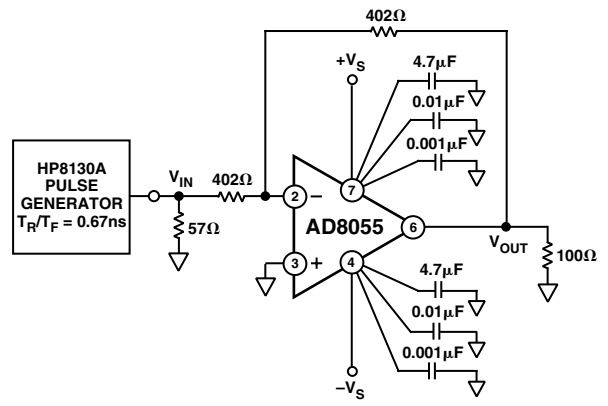

Figure 6. Test Circuit,  $G = -1$ ,  $R_L = 100\ \Omega$

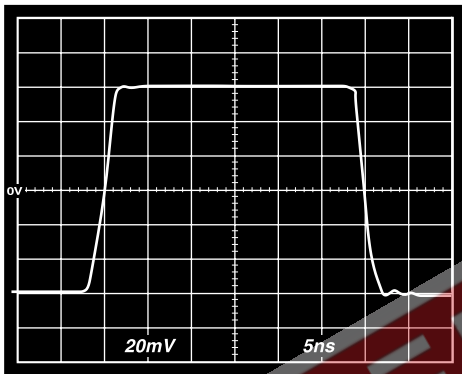

Figure 4. Small Step Response,  $G = +1$

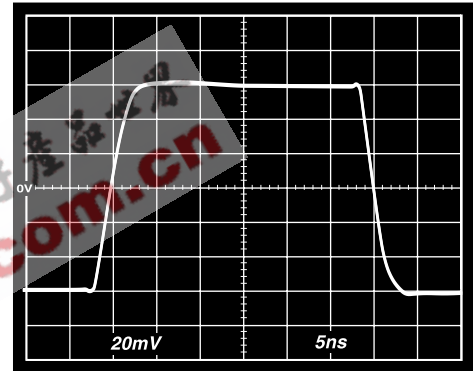

Figure 7. Small Step Response,  $G = -1$

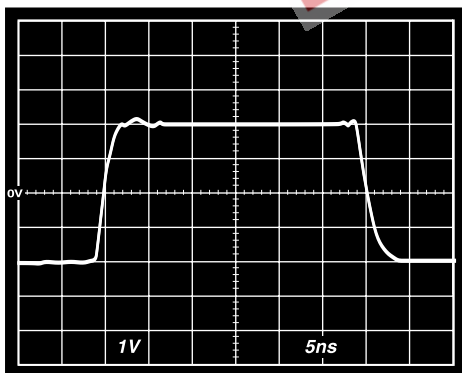

Figure 5. Large Step Response,  $G = +1$

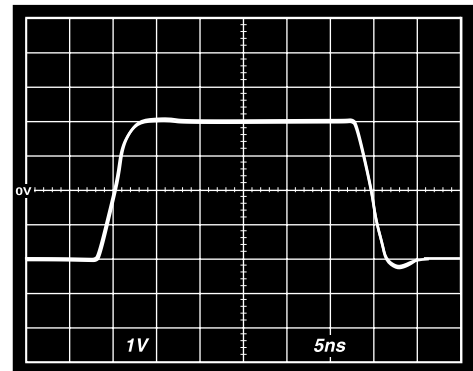

Figure 8. Large Step Response,  $G = -1$

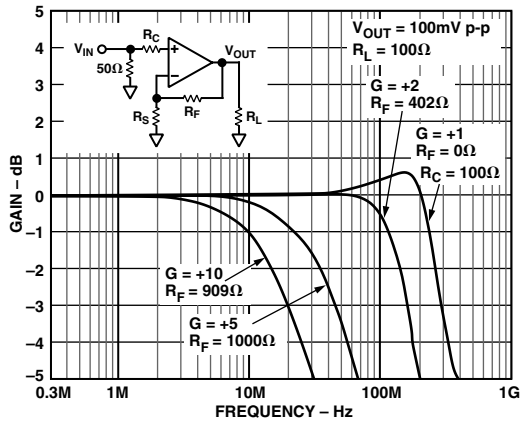

Figure 9. Small Signal Frequency Response,  $G = +1$ ,  $G = +2$ ,  $G = +5$ ,  $G = +10$

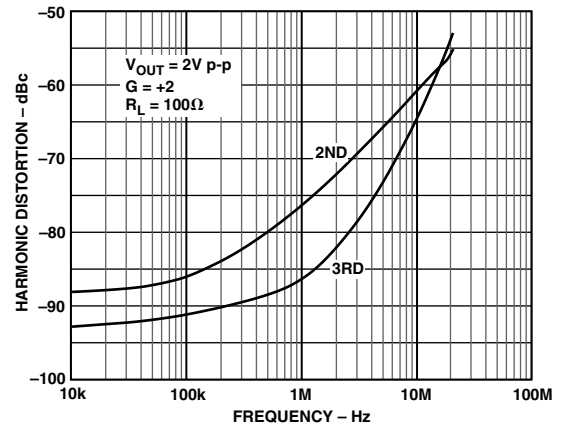

Figure 12. Distortion vs. Frequency

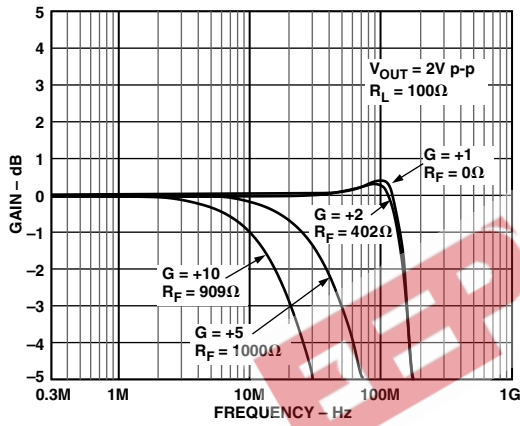

Figure 10. Large Signal Frequency Response,  $G = +1$ ,  $G = +2$ ,  $G = +5$ ,  $G = +10$

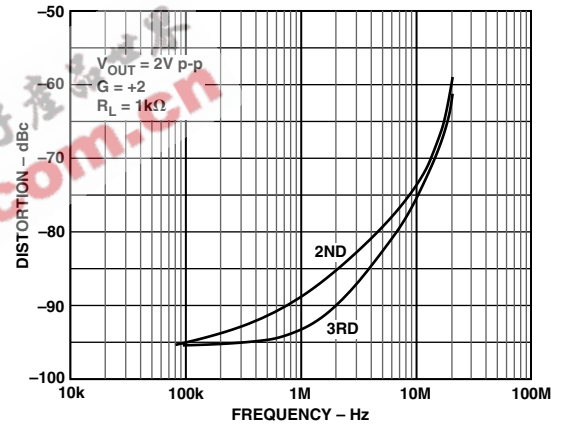

Figure 13. Distortion vs. Frequency

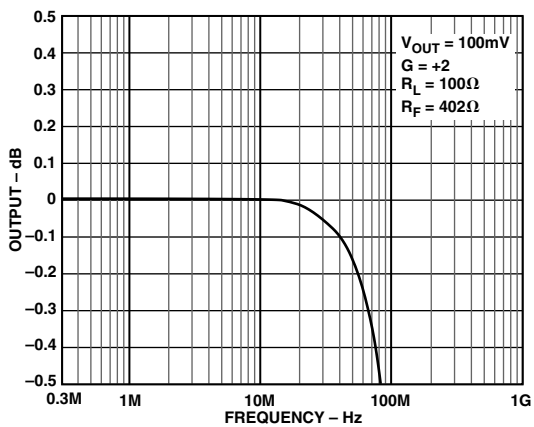

Figure 11. 0.1 dB Flatness

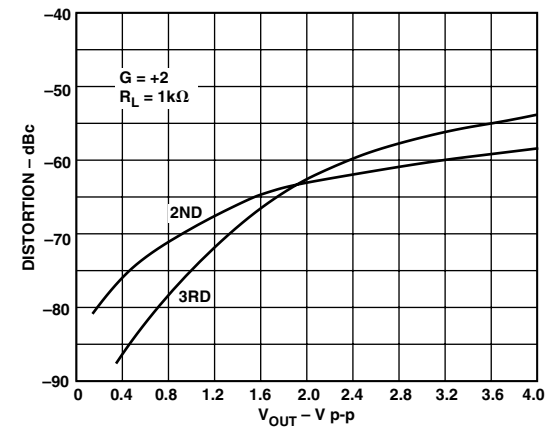

Figure 14. Distortion vs.  $V_{OUT}$  @ 20 MHz

# AD8055/AD8056

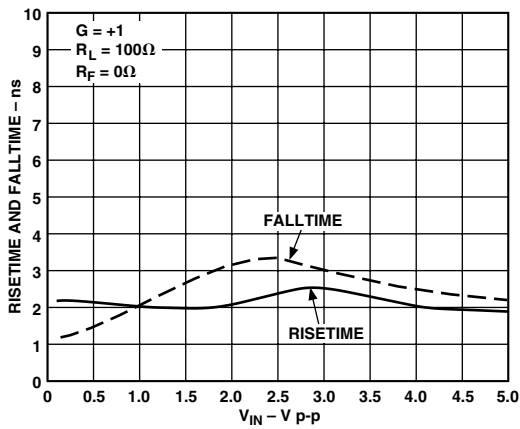

Figure 15. Risetime and Falltime vs.  $V_{IN}$

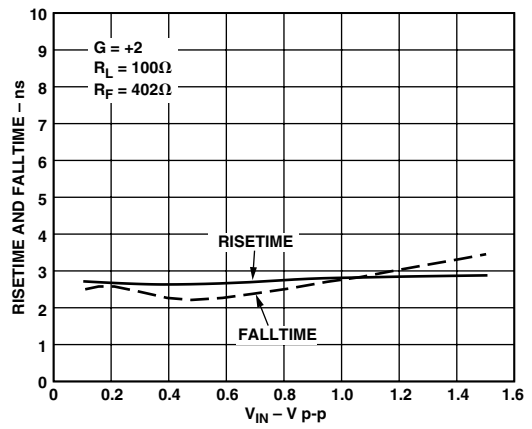

Figure 18. Risetime and Falltime vs.  $V_{IN}$

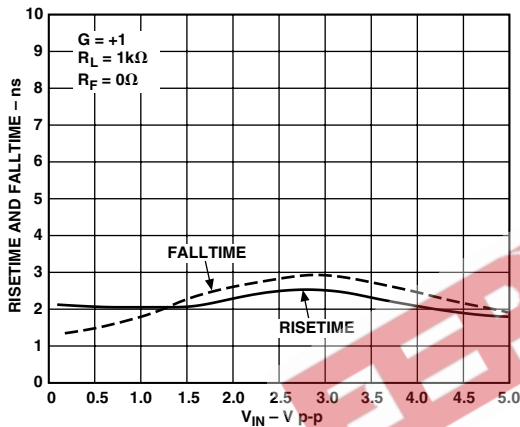

Figure 16. Risetime and Falltime vs.  $V_{IN}$

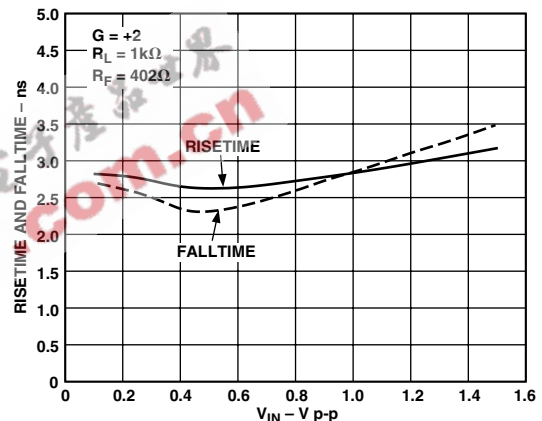

Figure 19. Risetime and Falltime vs.  $V_{IN}$

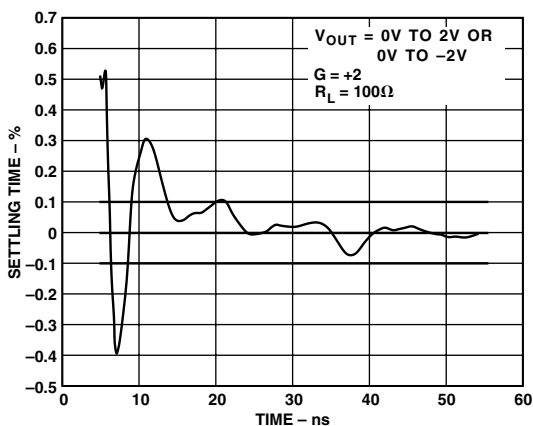

Figure 17. Settling Time

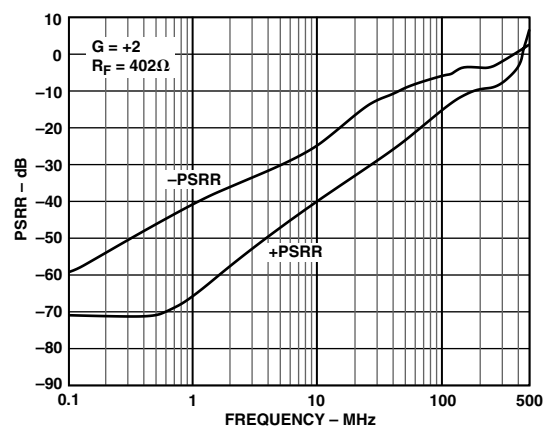

Figure 20. PSRR vs. Frequency

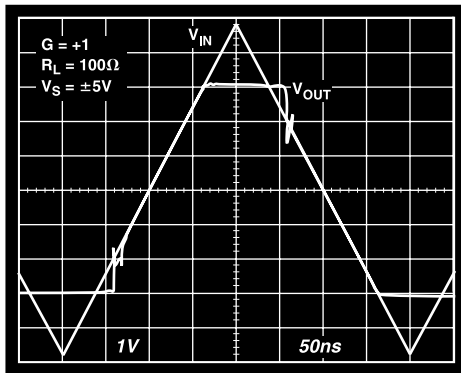

Figure 21. Overload Recovery

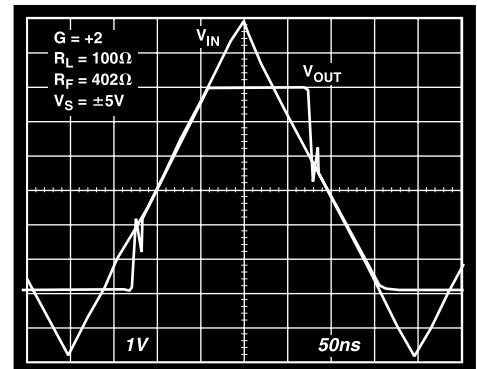

Figure 24. Overload Recovery

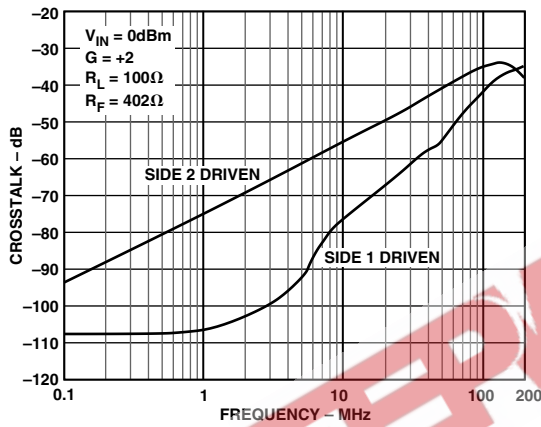

Figure 22. Crosstalk (Output-to-Output) vs. Frequency

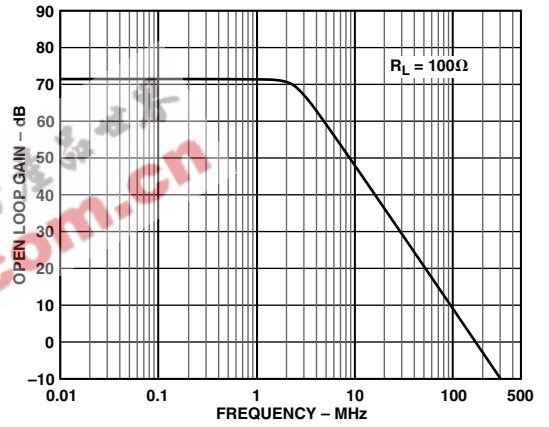

Figure 25. Open Loop Gain vs. Frequency

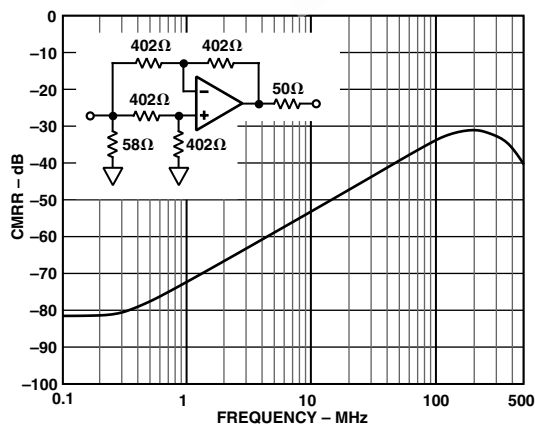

Figure 23. CMRR vs. Frequency

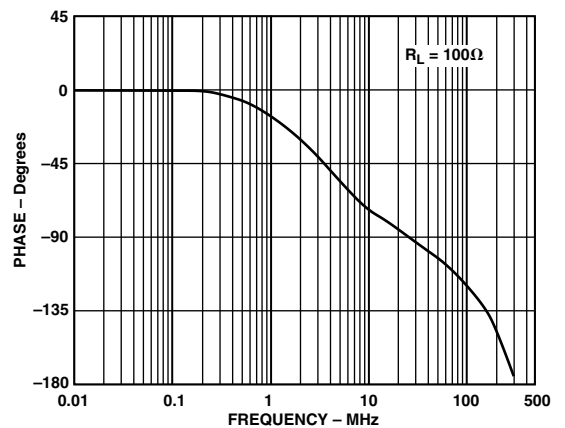

Figure 26. Phase vs. Frequency



# AD8055/AD8056

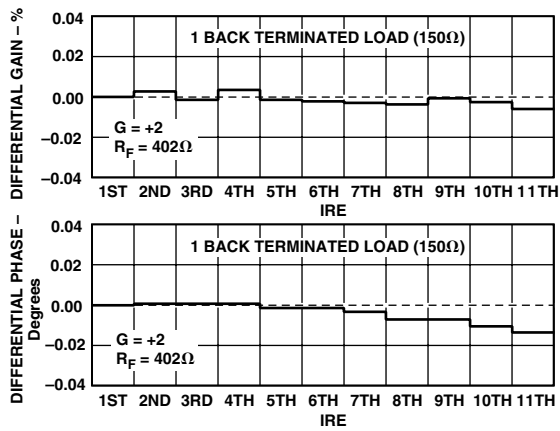

Figure 27. Differential Gain and Differential Phase

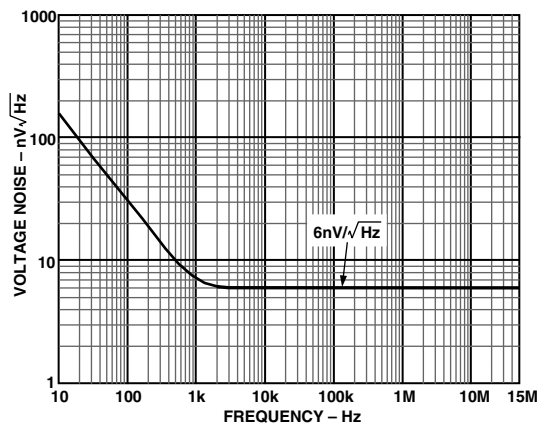

Figure 30. Voltage Noise vs. Frequency

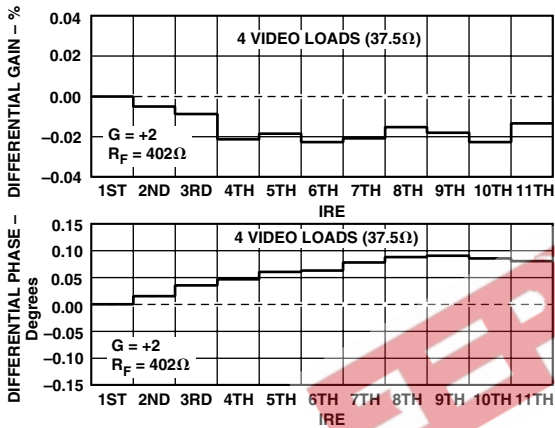

Figure 28. Differential Gain and Differential Phase

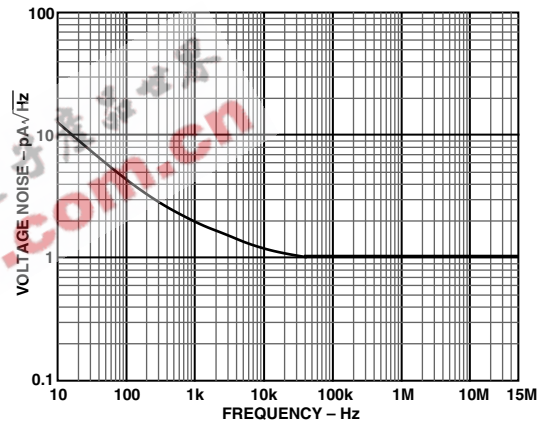

Figure 31. Current Noise vs. Frequency

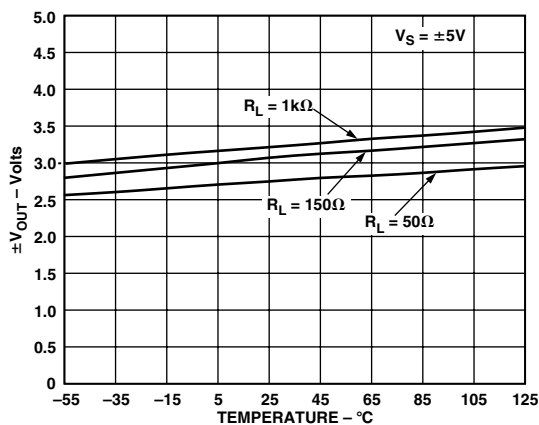

Figure 29. Output Swing vs. Temperature

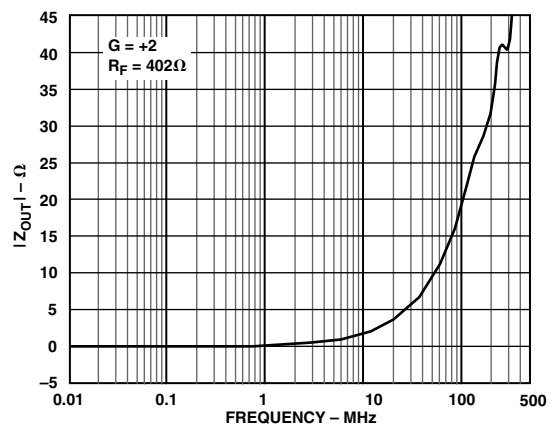

Figure 32. Output Impedance vs. Frequency



## APPLICATIONS

### Four-Line Video Driver

The AD8055 is a useful low cost circuit for driving up to four video lines. For such an application, the amplifier is configured for a noninverting gain of 2 as shown in Figure 33. The input video source is terminated in 75 Ω and applied to the high impedance noninverting input.

Each output cable is connected to the op amp output via a 75 Ω series back termination resistor for proper cable termination. The terminating resistors at the other ends of the lines will divide the output signal by two, which is compensated for by the gain-of-two of the op amp stage.

For a single load, the differential gain error of this circuit was measured to be 0.01%, with a differential phase error of 0.02 degrees. The two load measurements were 0.02% and 0.03 degrees, respectively. For four loads, the differential gain error is 0.02%, while the differential phase increases to 0.1 degrees.

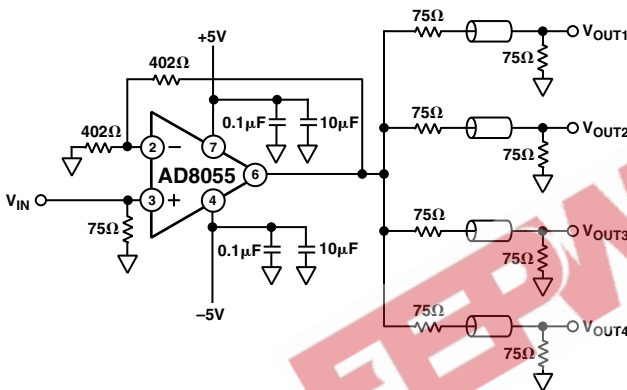

Figure 33. Four-Line Video Driver

### Single-Ended to Differential Line Driver

Creating differential signals from single-ended signals is required for driving balanced, twisted pair cables, differential input A/D converters and other applications that require differential signals. This is sometimes accomplished by using an inverting and a noninverting amplifier stage to create the complementary signals.

The circuit shown in Figure 34 shows how an AD8056 can be used to make a single-ended to differential converter that offers some advantages over the architecture mentioned above. Each op amp is configured for unity gain by the feedback resistors from the outputs to the inverting inputs. In addition, each output drives the opposite op amp with a gain of -1 by means of the crossed resistors. The result of this is that the outputs are complementary and there is high gain in the overall configuration.

Feedback techniques similar to a conventional op amp are used to control the gain of the circuit. From the noninverting input of Amp 1 to the output of Amp 2, is an inverting gain. Between these points a feedback resistor can be used to close the loop. As in the case of a conventional op amp inverting gain stage, an input resistor is added to vary the gain.

The gain of this circuit from the input to Amp 1 output is  $R_F/R_I$ , while the gain to the output of Amp 2 is  $-R_F/R_I$ . The circuit thus creates a balanced differential output signal from a single-ended input. The advantage of this circuit is that the gain can be changed by changing a single resistor and still maintain the balanced differential outputs.

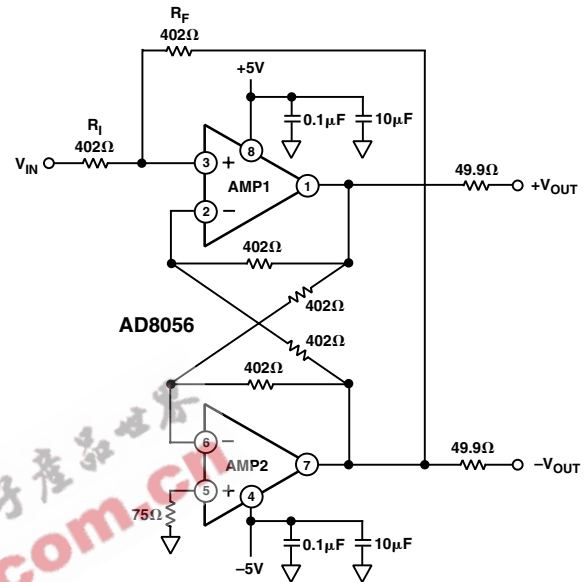

Figure 34. Single-Ended to Differential Line Driver

### Low Noise, Low Power Preamp

The AD8055 makes a good low cost, low noise, low power preamp. A gain of 10 preamp can be made with a feedback resistor of 909 ohms and a gain resistor of 100 ohms as shown in Figure 35. The circuit has a -3 dB bandwidth of 20 MHz.

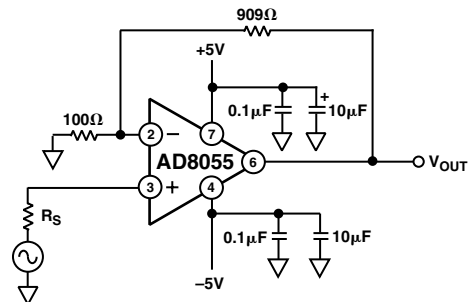

Figure 35. Low Noise, Low Power Preamp with  $G = 10$  and  $BW = 20$  MHz

With a low source resistance (<approximately 100 Ω), the major contributors to the input referred noise of this circuit are the input voltage noise of the amplifier and the noise of the 100 Ω resistor. These are  $6 \text{ nV}/\sqrt{\text{Hz}}$  and  $1.2 \text{ nV}/\sqrt{\text{Hz}}$ , respectively. These values yield a total input referred noise of  $6.1 \text{ nV}/\sqrt{\text{Hz}}$ .

# AD8055/AD8056

## Power Dissipation Limits

With a 10 V supply (total  $V_{CC} - V_{EE}$ ), the quiescent power dissipation of the AD8055 in the SOT-23-5 package is 65 mW, while the quiescent power dissipation of the AD8056 in the microSOIC is 120 mW. This translates into a 15.6°C rise above the ambient for the SOT-23-5 package and a 24°C rise for the microSOIC package.

The power dissipated under heavy load conditions is approximately equal to the supply voltage minus the output voltage, times the load current, plus the quiescent power computed above. This total power dissipation is then multiplied by the thermal resistance of the package to find the temperature rise, above ambient, of the part. The junction temperature should be kept below 150°C.

The AD8055 in the SOT-23-5 package can dissipate 270 mW while the AD8056 in the microSOIC package can dissipate 325 mW (at 85°C ambient) without exceeding the maximum die temperature. In the case of the AD8056, this is greater than 1.5 V rms into 50 Ω, enough to accommodate a 4 V p-p sine-wave signal on both outputs simultaneously. But since each output of the AD8055 or AD8056 is capable of supplying as much as 110 mA into a short circuit, a continuous short circuit condition will exceed the maximum safe junction temperature.

## Resistor Selection

The following table is provided as a guide to resistor selection for maintaining gain flatness vs. frequency for various values of gain.

Gain	$R_F$ (Ω)	$R_I$ (Ω)	-3 dB Bandwidth (MHz)
+1	0	—	300
+2	402	402	160
+5	1k	249	45
+10	909	100	20

## Driving Capacitive Loads

When driving a capacitive load, most op amps will exhibit peaking in the frequency response just before the frequency rolls off. Figure 36 shows the responses for an AD8056 running at a gain of +2, with a 100 Ω load that is shunted by various values of capacitance. It can be seen that under these conditions, the part is still stable with capacitive loads of up to 30 pF.

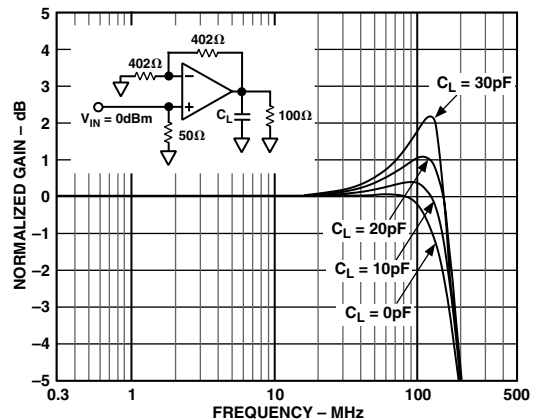

Figure 36. Capacitive Load Drive

In general, to minimize peaking or to ensure the stability for larger values of capacitive loads, a small series resistor,  $R_S$ , can be added between the op amp output and the capacitor,  $C_L$ . For the setup depicted in Figure 37, the relationship between  $R_S$  and  $C_L$  was empirically derived and is shown in Figure 38.  $R_S$  was chosen to produce less than 1 dB of peaking in the frequency response. Note also that after a sharp rise  $R_S$  quickly settles to about 25 Ω.

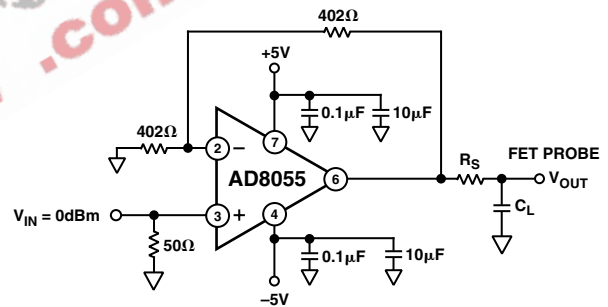

Figure 37. Setup for  $R_S$  vs.  $C_L$

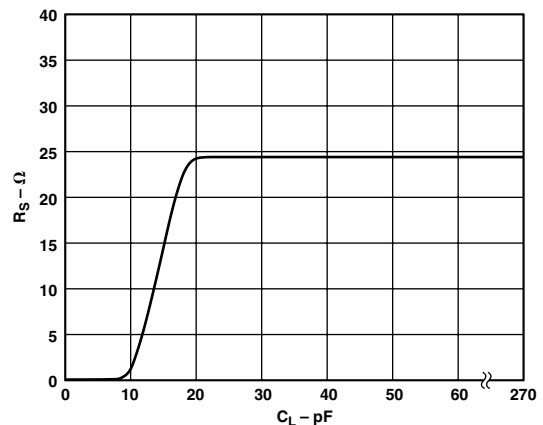
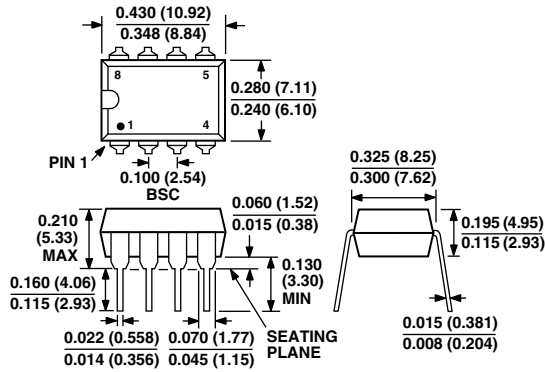

Figure 38.  $R_S$  vs.  $C_L$

## OUTLINE DIMENSIONS

Dimensions shown in inches and (mm).

### 8-Lead Plastic DIP (N-8)



### 8-Lead microSOIC Package (RM-8)

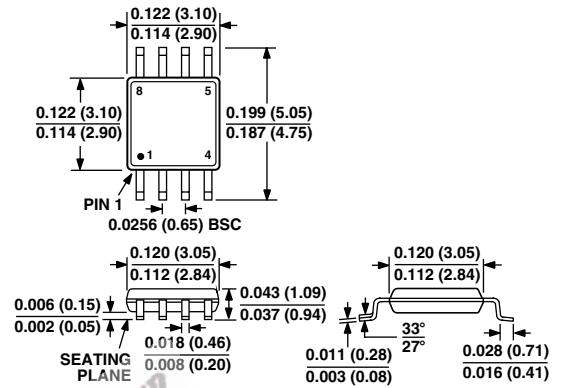

### 8-Lead Small Outline SOIC (SO-8)

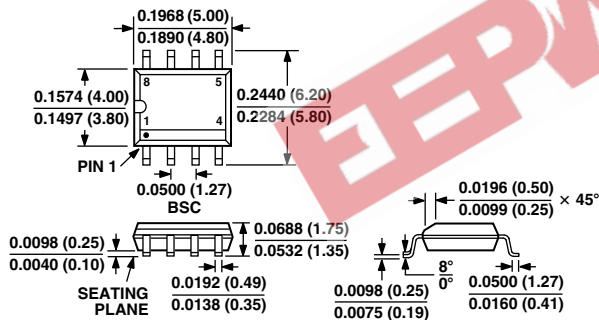

### 5-Lead Plastic Surface Mount (RT-5)

