

FEATURES

Analog Video to Digital YCrCb Video Decoder:
 NTSC-(M/N), PAL-(B/D/G/H/I/M/N)
ADV[®]7185 Integrates Two 12-Bit ADCs
Clocked from a Single 27 MHz Crystal
Dual Video Clamping Schemes:
 Line-Locked Clock Compatible (LLC)
Adaptive Digital Line Length Tracking (ADLLT[™])
3-Line Chroma Comb Filter
Real-Time Clock and Status Information Output
Integrated AGC (Automatic Gain Control) and Clamping
Multiple Programmable Analog Input Formats:
 CVBS (Composite Video)
 SVHS (Y/C)
 YCrCb Component (VESA, MII, SMPTE, and BetaCam)
6 Analog Input Video Channels
Real-Time Horizontal and Vertical Scaling
Automatic NTSC/PAL Identification
Differential Mode Video Input

Digital Output Formats (20-Bit Wide Bus):

YCrCb (4:2:2 or 4:1:1)
 CCIR601/CCIR656 8-Bit or Extended 10-Bit
 0.5 V to 2.0 V p-p Input Range
 Differential Gain, 0.4% Typ
 Differential Phase, 0.6° Typ
Programmable Video Controls:
 Peak White/Hue/Brightness/Saturation/Contrast
 CCIR/Square/4 F_{SC} Pixel Operation

APPLICATIONS

Projectors
 Digital TVs
 DVD-RAM Recorders and Players
 PDP Displays
 Video Decoders
 Hybrid Analog/Digital Set-Top Boxes
 Professional Equipment

(continued on page 9)

FUNCTIONAL BLOCK DIAGRAM

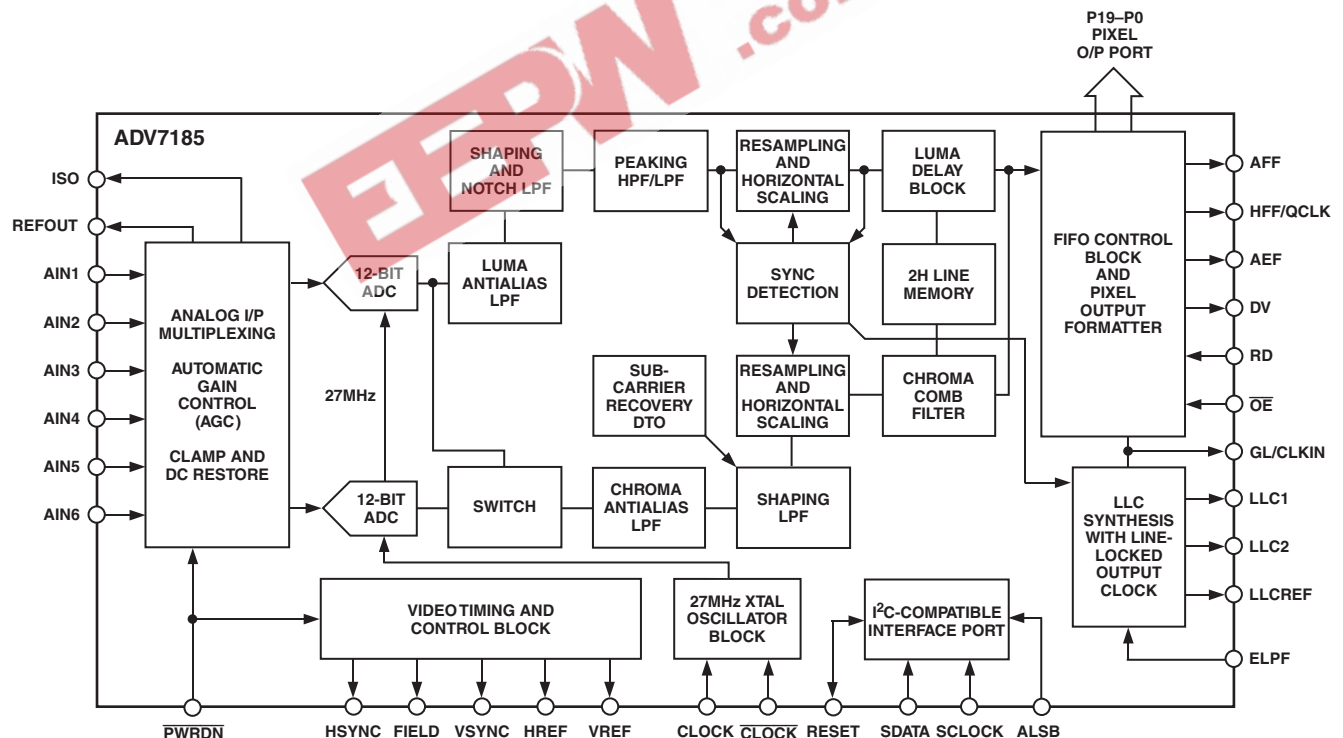

ADLLT is a trademark and ADV is a registered trademark of Analog Devices, Inc.

REV. 0

Information furnished by Analog Devices is believed to be accurate and reliable. However, no responsibility is assumed by Analog Devices for its use, nor for any infringements of patents or other rights of third parties that may result from its use. No license is granted by implication or otherwise under any patent or patent rights of Analog Devices.

ADV7185—SPECIFICATIONS¹ ($V_{AA} = 4.75\text{ V to }5.25\text{ V}$, $V_{DD} = 3.2\text{ V to }3.5\text{ V}$, $V_{DDIO} = 3.15\text{ V to }3.5\text{ V}$, T_{MIN} to T_{MAX} ², unless otherwise noted.)

Parameter	Min	Typ	Max	Unit	Test Conditions
STATIC PERFORMANCE					
Resolution (each ADC)			12	Bits	12-Bit Range
Accuracy (each ADC)		± 0.5	± 1.0	LSB	BSL, 2 V Input Captured in a 10-Bit Range
Integral Nonlinearity ³		± 0.175	± 0.325	LSB	2 V Input Captured in a 10-Bit Range
Differential Nonlinearity ³					
DIGITAL INPUTS³					
Input High Voltage, V_{INH}	2			V	$V_{IN} = 0.4\text{ V or }2.4\text{ V}$
Input Low Voltage, V_{INL}			0.8	V	
Input Current, I_{IN}	-10		+10	μA	
Input Capacitance, C_{IN}			10	pF	
DIGITAL OUTPUTS³					
Output High Voltage, V_{OH}	2.4			V	$I_{SOURCE} = 3.2\text{ mA}$ $I_{SINK} = 0.4\text{ mA}$
Output Low Voltage, V_{OL}			0.4	V	
High Impedance Leakage Current			10	μA	
Output Capacitance			30	pF	
VOLTAGE REFERENCE³					
Reference Range, V_{REFOUT}	2.15	2.2	2.25	V	$I_{VREFOUT} = 0\ \mu\text{A}$
POWER REQUIREMENTS					
Digital Power Supply, V_{DD}	3.2	3.3	3.5	V	Sleep Mode until Powered Up
Digital IO Power Supply, V_{DDIO}	3.15	3.3	3.5	V	
Analog Power Supply, V_{AA}	4.75	5.0	5.25	V	
Digital Supply Current, I_{DD}		125	165	mA	
Digital IO Supply Current, I_{DDIO}		7		mA	
Analog Supply Current, I_{AA} ⁴		150	180	mA	
Power-Up Time		1		Field	

NOTES

¹The max/min specifications are guaranteed over this range. The max/min values are typical over $V_{AA} = 4.75\text{ V to }5.25\text{ V}$, $V_{DD} = 3.2\text{ V to }3.5\text{ V}$, and $V_{DDIO} = 3.15\text{ V to }3.5\text{ V}$ range.

²Temperature Range T_{MIN} to $T_{MAX} = 0^{\circ}\text{C to }70^{\circ}\text{C}$

³Guaranteed by characterization.

⁴ I_{AA} is total analog current taken by AVDD supply pins.

Specifications subject to change without notice.

VIDEO PERFORMANCE SPECIFICATIONS^{1, 2} ($V_{AA} = 4.75\text{ V to } 5.25\text{ V}$, $V_{DD} = 3.2\text{ V to } 3.5\text{ V}$, $V_{DDIO} = 3.15\text{ V to } 3.5\text{ V}$, T_{MIN} to T_{MAX} ³, unless otherwise noted.)

Parameter	Min	Typ	Max	Unit	Test Conditions
NONLINEAR SPECIFICATIONS²					
Differential Phase		0.4		Degree	CVBS, Comb/No Comb
Differential Gain		0.6		%	CVBS, Comb/No Comb
Luma Nonlinearity		0.5		%	
NOISE SPECIFICATIONS²					
SNR (Ramp)	61	63		dB	CVBS
Analog Front End Channel Crosstalk		63		dB	S-Video/YUV, Single-Ended
		63		dB	S-Video/YUV, Differential-Ended
LOCK TIME AND JITTER SPECIFICATIONS²					
Horizontal Lock Time		50		Lines	TV/VCR Mode
Horizontal Recovery Time		50		Lines	
Horizontal Lock Range		±5		%	
Line Length Variation Over Field		±1		%	VCR Mode/Surveillance Mode
		±1		%	TV Mode
HLock Lost Declared	10	20		HSync	TV Mode, Number of Missing HSyncs
				HSync	VCR/Surveillance Mode, Number of Missing HSyncs
Vertical Lock Time		2		VSynC	First Lock into Video Signal
VLock Lost Declared		1		VSynC	All Modes, Number of Missing VSynCs
F _{SC} Subcarrier Lock Range		±400		Hz	NTSC/PAL
Color Lock Time		50		Lines	HLock to Color Lock Time
LLC Clock Jitter (Short Time Jitter)		1		ns	RMS Clock Jitter
LLC Clock Jitter (Frame Jitter)		37		ns	RMS Clock Jitter
CHROMA-SPECIFIC SPECIFICATIONS²					
Hue Accuracy		0.5		Degree	
Color Saturation Accuracy		0.6		%	
Color Gain Control Range	-6		+18	dB	S-Video, YUV, Overall CGC Range (Analog and Digital)
Analog Color Gain Range	-6		+6	dB	S-Video, YUV
Digital Color Gain Range	0		12	dB	CVBS, S-Video, YUV
Chroma Amplitude Error		0.1		%	
Chroma Phase Error		0		Degree	
Chroma Luma Intermodulation		0.1		%	
LUMA-SPECIFIC SPECIFICATIONS²					
Luma Brightness Accuracy		1.0		%	Video Input Range = 1.0 V p-p
Luma Contrast Accuracy		1.0		%	Video Input Range = 1.0 V p-p

NOTES

¹The max/min specifications are guaranteed over this range. The max/min values are typical over $V_{AA} = 4.75\text{ V to } 5.25\text{ V}$, $V_{DD} = 3.2\text{ V to } 3.5\text{ V}$, and $V_{DDIO} = 3.15\text{ V to } 3.5\text{ V}$ range.

²Guaranteed by characterization.

³Temperature range T_{MIN} to $T_{MAX} = 0^{\circ}\text{C to } 70^{\circ}\text{C}$

Specifications subject to change without notice.

ADV7185

TIMING SPECIFICATIONS¹ ($V_{AA} = 4.75\text{ V to }5.25\text{ V}$, $V_{DD} = 3.2\text{ V to }3.5\text{ V}$, $V_{DDIO} = 3.15\text{ V to }3.5\text{ V}$, T_{MIN} to T_{MAX} ², unless otherwise noted.)

Parameter	Min	Typ	Max	Unit	Test Conditions
SYSTEM CLOCK AND CRYSTAL					
Nominal Frequency		27		MHz	
I²C PORT³					
SCL Clock Frequency	0		400	kHz	
SCL Min Pulsewidth High, t_1	0.6			μs	
SCL Min Pulsewidth Low, t_2	1.3			μs	
Hold Time (Start Condition), t_3	0.6			μs	
Setup Time (Start Condition), t_4	0.6			μs	
Data Setup Time, t_5	100			ns	
SCL/SDA Rise Time, t_6			300	ns	
SCL/SDA Fall Time, t_7			300	ns	
Setup Time (Stop Condition), t_8		0.6		μs	
RESET FEATURE					
Reset Pulse Input Width	74			ns	
CLOCK OUTPUTS³					
LLC1 Cycle Time, t_9		37		ns	CCIR601 Mode 27 MHz
LLC1 Cycle Time, t_9		33.9		ns	PAL Square Pixel Mode 29.5 MHz
LLC1 Cycle Time, t_9		40.8		ns	NTSC Square Pixel Mode 24.5 MHz
LLC1 Min Low Period, t_{10}		18		ns	CCIR601 Mode 27 MHz
LLC1 Min High Period, t_{11}		18		ns	CCIR601 Mode 27 MHz
LLC1 Falling to LLCREF Falling, t_{12}		4		ns	
LLC1 Falling to LLCREF Rising, t_{13}		6		ns	
LLC1 Rising to LLC2 Rising, t_{14}		3	5	ns	
LLC1 Rising to LLC2 Falling, t_{15}		1	3	ns	
CLKIN Cycle Time, t_{18}		37		ns	SCAPI and CAPI Modes
DATA AND CONTROL OUTPUT					
Data Output Hold Time, t_{17}	26			ns	LLC Mode
Data Output Access Time, t_{16}		30	33	ns	LLC Mode
Data Output Access Time, t_{19}		20	25	ns	SCAPI and CAPI Modes
Data Output Hold Time, t_{20}	6	11		ns	SCAPI and CAPI Modes
Propagation Delay to High Z, t_{21}		5	8	ns	
Max Output Enable Access Time, t_{22}		8	11	ns	
Min Output Enable Access Time, t_{23}	2	5		ns	

NOTES

¹The max/min specifications are guaranteed over this range. The max/min values are typical over $V_{AA} = 4.75\text{ V to }5.25\text{ V}$, $V_{DD} = 3.2\text{ V to }3.5\text{ V}$, and $V_{DDIO} = 3.15\text{ V to }3.5\text{ V}$ range.

²Temperature range T_{MIN} to $T_{MAX} = 0^\circ\text{C to }70^\circ\text{C}$

³Guaranteed by characterization.

Specifications subject to change without notice.

ANALOG FRONT END SPECIFICATIONS¹ ($V_{AA} = 4.75\text{ V to }5.25\text{ V}$, $V_{DD} = 3.2\text{ V to }3.5\text{ V}$, $V_{DDIO} = 3.15\text{ V to }3.5\text{ V}$, T_{MIN} to T_{MAX} ², unless otherwise noted.)

Parameter	Min	Typ	Max	Unit	Test Conditions
CLAMP CIRCUITRY					
External Clamp Capacitor		0.1		μF	
Input Impedance		10		$\text{M}\Omega$	Clamp Switched Off
Voltage Clamp Level		1.4		V	
Clamp Source Current		+3		μA	Signal Already Clamped (Fine Clamping)
Clamp Sink Current		-3		μA	Signal Already Clamped (Fine Clamping)
Clamp Source Current		+0.9		mA	Acquire Mode (Fast Clamping)
Clamp Sink Current		-0.9		mA	Acquire Mode (Fast Clamping)

NOTES

¹The max/min specifications are guaranteed over this range. The max/min values are typical over $V_{AA} = 4.75\text{ V to }5.25\text{ V}$, $V_{DD} = 3.2\text{ V to }3.5\text{ V}$, and $V_{DDIO} = 3.15\text{ V to }3.5\text{ V}$ range.

²Temperature range T_{MIN} to $T_{MAX} = 0^\circ\text{C to }70^\circ\text{C}$

Specifications subject to change without notice.

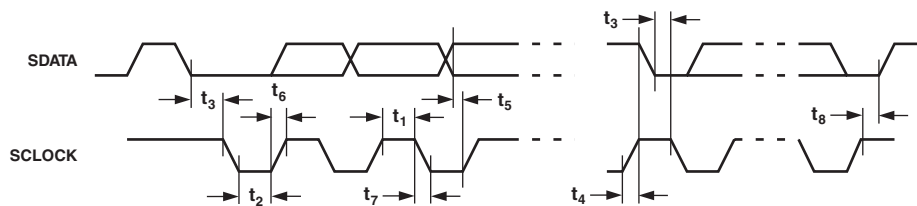

Figure 1. MPU Port Timing Diagram

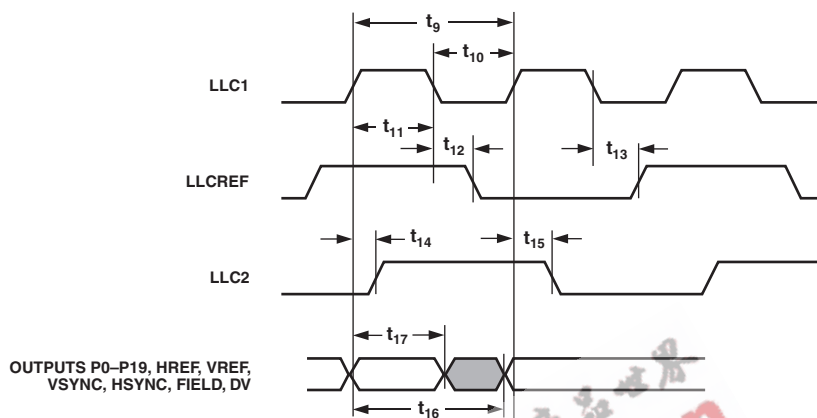

Figure 2. LLC Clock, Pixel Port, and Control Outputs Timing Diagram

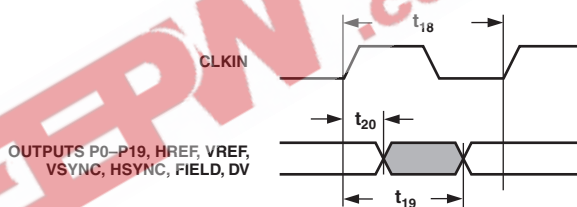

Figure 3. Pixel Port and Control Outputs in CAPI and SCAPI Mode Timing Diagram

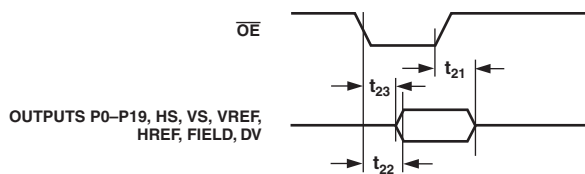

Figure 4. \overline{OE} Timing Diagram

ADV7185

ABSOLUTE MAXIMUM RATINGS¹

V _{AA} to GND	7 V
V _{DD} to GND	4 V
V _{DDIO} to GND	4 V
Voltage on Digital Input Pins	GND – 0.5 V to V _{AA} + 0.5 V
Storage Temperature (T _S)	–65°C to +150°C
Junction Temperature (T _J)	150°C
Lead Temperature (Soldering, 10 sec)	260°C
Analog Outputs to GND ²	GND – 0.5 V to V _{AA}

ORDERING GUIDE

Model	Temperature Range	Package
ADV7185KST	0°C to 70°C	80-LQFP

NOTES

¹Stresses above those listed under Absolute Maximum Ratings may cause permanent damage to the device. This is a stress rating only; functional operation of the device at these or any other conditions above those listed in the operational sections of this specification is not implied. Exposure to absolute maximum rating conditions for extended periods may affect device reliability.

²Analog output short circuit to any power supply or common can be of an indefinite duration.

CAUTION

ESD (electrostatic discharge) sensitive device. Electrostatic charges as high as 4000 V readily accumulate on the human body and test equipment and can discharge without detection. Although the ADV7185 features proprietary ESD protection circuitry, permanent damage may occur on devices subjected to high energy electrostatic discharges. Therefore, proper ESD precautions are recommended to avoid performance degradation or loss of functionality.



PIN CONFIGURATION

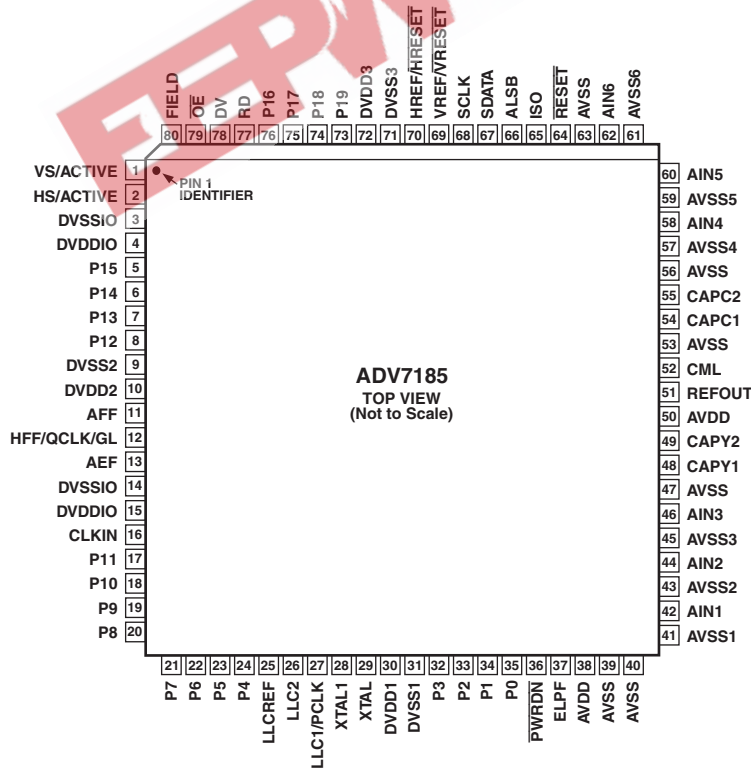

PIN FUNCTION DESCRIPTIONS

Pin	Mnemonic	Input/Output	Function
1	VS/VACTIVE	O	VS or Vertical Sync. A dual-function pin, (OM_SEL[1:0] = 0, 0) is an output signal that indicates a vertical sync with respect to the YUV pixel data. The active period of this signal is six lines of video long. The polarity of the VS signal is controlled by the PVS bit. VACTIVE (OM_SEL[1:0] = 1, 0 or 0, 1) is an output signal that is active during the active/viewable period of a video field. The polarity of VACTIVE is controlled by the PVS bit.
2	HS/HACTIVE	O	HS or Horizontal Sync. A dual-function pin, (OM_SEL[1:0] = 0, 0) is a programmable horizontal sync output signal. The rising and falling edges can be controlled by HSB[9:0] and HSE[9:0] in steps of 2 LLC1. The polarity of the HS signal is controlled by the PHS bit. HACTIVE (OM_SEL[1:0] = 1, 0 or 0, 1) is an output signal that is active during the active/viewable period of a video line. The active portion of a video line is programmable on the ADV7185. The polarity of HACTIVE is controlled by PHS bit.
3, 14	DVSSIO	G	Digital I/O Ground
4, 15	DVDDIO	P	Digital I/O Supply Voltage (3.3 V)
5–8, 17–24, 32–35, 73–76	P19–P0	O	Video Pixel Output Port. 8-bit multiplexed YCrCb pixel port (P19–P12); 16-bit YCrCb pixel port (P19–P12 = Y and P9–P2 = Cb,Cr); 10-bit multiplexed extended YCrCb pixel port (P19–P10); and 20-bit YCrCb pixel port (P19–P0). P0 represents the LSB, P1–P0 can also be configured as gPO [1] and gPO [0], and P11–P10 can be configured as gPO [3] and gPO [2] respectively.
9, 31, 71	DVSS1–DVSS3	G	Ground for Digital Supply
10, 30, 72	DVDD1–DVDD3	P	Digital Supply Voltage (3.3 V)
11	AFF	O	Almost Full Flag. A FIFO control signal indicating when the FIFO has reached the almost full margin set by the user (use FFM[4:0]). The polarity of this signal is controlled by the PFF bit.
12	HFF/QCLK/GL	I/O	Half Full Flag. A multifunction pin (OM_SEL[1:0] = 1, 0), it is a FIFO control signal that indicates when the FIFO is half full. The QCLK (OM_SEL[1:0] = 0, 1) pin function is a qualified pixel output clock when using FIFO SCAPI mode. The GL (OM_SEL[1:0] = 0, 0) function (Genlock output) is a signal that contains a serial stream of data that contains information for locking the subcarrier frequency. The polarity of HFF signal is controlled by the PFF bit.
13	AEF	O	Almost Empty Flag. A FIFO control signal, it indicates when the FIFO has reached the almost empty margin set by the user (use FFM[4:0]). The polarity of this signal is controlled by the PFF bit.
16	CLKIN	I	Asynchronous FIFO Clock. This asynchronous clock is used to output data onto the P19–P0 bus and other control signals.
25	LLCREF	O	Clock Reference Output. This is a clock qualifier distributed by the internal CGC for a data rate of LLC2. The polarity of LLCREF is controlled by the PLLCREF bit.
26	LLC2	O	Line-Locked Clock System Output Clock/2 (13.5 MHz)
27	LLC1/PCLK	O	Line-Locked Clock System Output Clock. A dual-function pin (27 MHz \pm 5%) or a FIFO output clock ranging from 20 MHz to 35 MHz.
28	XTAL1	O	Second terminal for crystal oscillator; not connected if external clock source is used.
29	XTAL	I	Input terminal for 27 MHz crystal oscillator or connection for external oscillator with CMOS-compatible square wave clock signal
36	$\overline{\text{PWRDN}}$	I	Power-Down Enable. A logical low will the place part in a power-down status.
37	ELPF	P	This pin is used for the External Loop Filter that is required for the LLC PLL.
38	AVDD	G	Analog Supply Voltage (+5 V)

PIN FUNCTION DESCRIPTIONS (continued)

Pin	Mnemonic	Input/Output	Function
39, 40, 47, 53, 56, 63	AVSS	G	Ground for Analog Supply
41, 43, 45, 57, 59, 61	AVSS1–AVSS6	G	Analog Input Channels. Ground if single-ended mode is selected. These pins should be connected directly to REFOUT when differential mode is selected.
42, 44, 46, 58, 60, 62	AIN1–AIN6	I	Video Analog Input Channels
48, 49	CAPY1–CAPY2	I	ADC Capacitor Network
50	AVDD	P	Analog Supply Voltage (5 V)
51	REFOUT	O	Internal Voltage Reference Output
52	CML	O	Common-Mode Level for ADC
54, 55	CAPC1–CAPC2	I	ADC Capacitor Network
64	$\overline{\text{RESET}}$	I	System Reset Input. Active Low
65	ISO	I	Input Switch Over. A low to high transition on this input indicates to the decoder core that the input video source has been changed externally and configures the decoder to reacquire the new timing information of the new source. This is useful in applications where external video muxes are used. This input gives the advantage of faster locking to the external muxed video sources. A low to high transition triggers this input.
66	ALSB	I	TTL Address Input. Selects the MPU address: MPU address = 88h ALSB = 0, disables I ² C filter MPU address = 8Ah ALSB = 1, enables I ² C filter
67	SDATA	I/O	MPU Port Serial Data Input/Output
68	SCLOCK	I	MPU Port Serial Interface Clock Input
69	VREF/ $\overline{\text{RESET}}$	O	VREF or Vertical Reference Output Signal. Indicates start of next field. $\overline{\text{RESET}}$ or Vertical Reset Output is a signal that indicates the beginning of a new field. In SCAPI/CAPI mode this signal is one clock wide and active low relative to CLKIN. It immediately follows the $\overline{\text{HRESET}}$ pixel, and indicates that the next active pixel is the first active pixel of the next field.
70	HREF/ $\overline{\text{HRESET}}$	O	HREF or Horizontal Reference Output Signal. A dual-function pin (enabled when Line-Locked Interface is selected, OM_SEL[1:0] = 0,0), this signal is used to indicate data on the YUV output. The positive slope indicates the beginning of a new active line, HREF is always 720 Y samples long. $\overline{\text{HRESET}}$ or Horizontal Reset Output (enabled when SCAPI or CAPI is selected, OM_SEL[1:0] = 0, 1 or 1, 0) is a signal that indicates the beginning of a new line of video. In SCAPI/CAPI this signal is one clock cycle wide and is output relative to CLKIN. It immediately follows the last active pixel of a line. The polarity is controlled via PHVR.
77	RD	I	Asynchronous FIFO Read Enable Signal. A logical high on this pin enables a read from the output of the FIFO.
78	DV	O	DV or Data Valid Output Signal. In SCAPI/CAPI mode, DV performs two functions, depending on whether SCAPI or CAPI is selected. It toggles high when the FIFO has reached the AFF margin set by the user, and remains high until the FIFO is empty. The alternative mode is where it can be used to control FIFO reads for bursting information out of the FIFO. In API mode DV indicates valid data in the FIFO, which includes both pixel information and control codes. The polarity of this pin is controlled via PDV.
79	$\overline{\text{OE}}$	I	Output Enable Controls Pixel Port Outputs. A logic high will three-state P19–P0.
80	FIELD	O	ODD/EVEN Field Output Signal. An active state indicates that an even field is being digitized. The polarity of this signal is controlled by the PF bit.

(FEATURES continued from page 1)

Simplified Digital Interface

On-Board Digital FIFO

Optimized Programmable Video Source Modes:

Broadcast TV

VCR/Camcorder

Security/Surveillance

Integrated On-Chip Video Timing Generator

Synchronous or Asynchronous Output Timing

Line-Locked Clock Output

Closed Captioning Passthrough Operation

Vertical Blanking Interval Support

Power-Down Mode

2-Wire Serial MPU Interface (I²C-Compatible)

5 V Analog 3.3 V Digital Supply Operation

80-Lead LQFP Package

GENERAL DESCRIPTION

The ADV7185 is an integrated video decoder that automatically detects and converts a standard analog baseband television signal compatible with worldwide standards NTSC or PAL into 4:2:2 or 4:1:1 component video data compatible with 16-/8-bit CCIR601/CCIR656 or 10-/20-bit extended standards.

The advanced and highly flexible digital output interface enables performance video decoding and conversion in both frame-buffer-based and line-locked, clock-based systems. This makes the device ideally suited for a broad range of applications with diverse analog video characteristics, including tape-based sources, broadcast sources, security/surveillance cameras, and professional systems.

Fully integrated line stores enable real-time horizontal and vertical scaling of captured video down to icon size. The 12-bit accurate A/D conversion provides professional quality SNR performance. This allows true 8-bit resolution in the 8-bit output mode, and broadcast quality in the 10-bit extended mode.

The six analog input channels accept standard composite or advanced component video including S-video and YCrCb video signals in an extensive number of combinations. AGC and clamp restore circuitry allow an input video signal peak-to-peak range of 0.5 V up to 2 V. Alternatively, these can be bypassed for manual settings.

The fixed 27 MHz clocking of the ADCs and data path for all modes allows very precise and accurate sampling and digital filtering. The line-locked clock output allows the output data rate, timing signals, and output clock signals to be synchronous, asynchronous, or line-locked even with $\pm 5\%$ line length variation. The output control signals allow glueless interface connection in almost any application.

The ADV7185 modes are set up over a 2-wire serial bidirectional port (I²C-compatible).

The ADV7185 is fabricated in a 5 V CMOS process. Its monolithic CMOS construction ensures greater functionality with lower power dissipation.

The ADV7185 is packaged in a small 80-pin LQFP package.

ANALOG INPUT PROCESSING

The ADV7185 has six analog video input channels. These six channels can be arranged in a variety of configurations to support up to six CVBS input signals, three S-video input signals and two YCrCb component analog video input signals. The INSEL[3:0] bits control the input type and channel selected. The analog front end includes three clamp circuits for dc restore. There are three sample-and-hold amplifiers prior to the ADC that are used to enable simultaneous sampling of up to three channels in a YCrCb input mode. Two 12-bit ADCs are used for sampling. The entire analog front end is fully differential which ensures that the video is captured to the highest quality possible. This is very important in highly integrated systems such as video decoders. Figure 5 shows the analog front end section of the ADV7185.

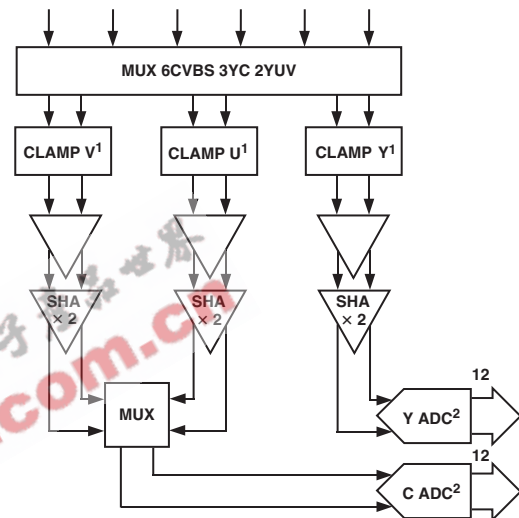

NOTES
 ANALOG SIGNAL PATH KEPT FULLY DIFFERENTIAL ADCs: 12-BIT ACCURATE; 12dB GAIN RANGE
¹CLAMP BLOCKS CONTAIN A SET OF CURRENT SOURCES FOR DC RESTORATION; U AND V HAVE ONLY HALF BANDWIDTH (SAMPLED SIMULTANEOUSLY, CONVERTED SEQUENTIALLY)
²PIPELINED

Figure 5. Analog Front End Block Diagram

CLAMPING

The clamp control on the ADV7185 consists of a digitally controlled analog current and voltage clamp and a digitally controlled digital clamp circuit. The coupling capacitor on each channel is used to store and filter the clamping voltage. A digital controller controls the clamp up and down current sources that charge the capacitor on every line. Four current sources are used in the current clamp control, two large current sources are used for coarse clamping, and two small current sources are used for fine clamping. The voltage clamp, if enabled, is only used on startup or if a channel is switched; this clamp pulls the video into the midrange of the ADC, which results in faster clamping and faster lock-in time for the decoder. The fourth clamp controller is fully digital and clamps the ADC output data, which results in extremely accurate clamping. It also has the added advantage of being fully digital, which results in very fast clamp timing and makes the entire clamping process very robust in terms of handling large amounts of hum that can be present on real-world video signals.

In S-video mode there are two clamp controllers used to separately control the luminance clamping and the chrominance

ADV7185

clamping. Also, in YCrCb component input mode there are two clamp controllers used to control the luminance clamping and the CrCb clamping separately; there are, however, individual current clamps on the Cr and Cb inputs.

User programmability is built into the clamp controllers which enable the current and digital clamp controllers to be set up to user-defined conditions. Refer to analog clamp control register (14h), digital clamp control register (15h), and digital color clamp offset register (15h and 16h) for control settings.

ANALOG-TO-DIGITAL CONVERTERS

Two 12-bit ADCs are used in the ADV7185, and they run from a 27 MHz input clock. An integrated band gap generates the required reference voltages for the converters. If the decoder is configured in CVBS mode, the second ADC can be switched off to reduce power consumption; see PSC[1:0].

AUTOMATIC GAIN CONTROL

The AGC control block on the ADV7185 is a digitally based system. This controller ensures that the input video signal (CVBS, S-video, or YCrCb) is scaled to its correct value such that the YCrCb digital output data matches the correct gain of the video signal. The AGC has an analog input video range of 0.5 V p-p to 2.0 V p-p, which gives a -6 dB to +6 dB gain range. Figure 6 demonstrates this range. This AGC range will compensate for video signals that have been incorrectly terminated or have been attenuated due to cable loss, or other factors.

There are two main control blocks: one for the luminance channel and one for the chrominance channel.

The luminance automatic gain control has eight modes of operation:

1. Manual AGC mode where gain for luminance path is set manually using LGM[11:0].
2. Blank level to sync tip is used to set luminance gain; manual MIRE[2:0] controls the maximum value through luminance channel. There is no override of this mode when white peak mode is detected.
3. Blank level to sync tip is used to set luminance gain; manual MIRE[2:0] controls the maximum value through luminance channel. There is override of this mode when white peak mode is detected. White peak mode is activated when the input video exceeds the maximum luminance range for long periods, this mode is designed to prevent clipping of the input video signal.
4. Blank level to sync tip is used to set luminance gain; MIRE[2:0] is automatically controlled to set the maximum value through the luminance channel. There is no override of this mode when white peak mode is detected.
5. Blank level to sync tip is used to set luminance gain; manual MIRE[2:0] is automatically controlled to set the maximum value through the luminance channel. There is override of

this mode when white peak mode is detected. White peak mode is activated when the input video exceeds the maximum luminance range for long periods; this mode is designed to prevent clipping of the input video signal.

6. Based on the active video peak white. PW_UPD sets the gain update frequency (once per video per field).
7. Based on the average active video. PW_RES sets what lines are used, only relevant if the signal conforms to PAL 625 line standard.
8. The luminance channel gain is frozen at its present value.

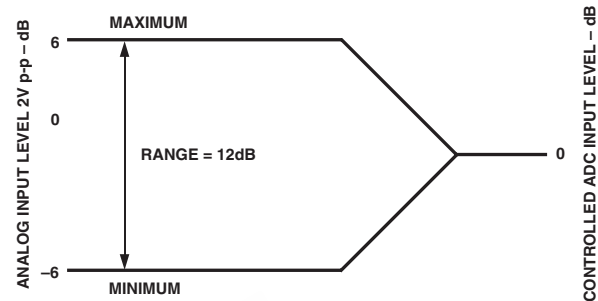

Figure 6. Analog Input Range

The chrominance automatic gain control has four modes of operation:

1. Manual AGC mode where gain for chrominance path is set manually using CGM[11:0].
2. Luminance gain used for chrominance channel.
3. Chrominance automatic gain based on color burst amplitude.
4. Chrominance gain frozen at its present setting.

Both the luminance and chrominance AGC controllers have a programmable time constant that allows the AGC to operate in four modes: slow, medium, fast, and video quality controlled.

The maximum IRE (MIRE[2:0]) control can be used to set the maximum input video range that can be decoded. Table I shows the selectable range.

Table I. MIRE Control

MIRE[2:0]	Function	
	PAL (IRE)	NTSC (IRE)
0 0 0	133	122
0 0 1	125	115
0 1 0	120	110
0 1 1	115	105
1 0 0	110	100
1 0 1	105	100
1 1 0	100	100
1 1 1	100	100

LUMINANCE PROCESSING

Figure 7 shows the luminance data path. The 12-bit data from the Y ADC is applied to an antialiasing low-pass filter that is designed to band-limit the input video signal such that aliasing does not occur. This filter dramatically reduces the design on an external analog antialiasing filter; this filter need only remove components in the input video signal above 22 MHz. The data then passes through a shaping or notch filter.

When in CVBS mode, a notch filter must be used to remove the unwanted chrominance data that lies around the subcarrier frequency. A wide variety of programmable notch filters for both PAL and NTSC are available. The YSFM[4:0] control the selection of these filters; refer to Figures 8 and 9 for plots of these filters. If S-video or component mode is selected a notch filter is not required. The ADV7185 offers 18 possible shaping filters (SVHS1-18) with a range of low-pass filter responses from 0.5 MHz up to 5.75 MHz. The YSFM[4:0] control the selection of these filters. Please refer to Figures 8 through 16 for filter plots.

The next stage in the luminance processing path is a peaking filter. This filter offers a sharpness function on the luminance path. The degree of sharpness can be selected using YPM[2:0]. If no sharpness is required, this filter can be bypassed.

The luminance data is then passed through a resampler to correct for line length variations in the input video. This resampler is designed to always output 720 pixels per line for standard PAL or NTSC. The resampler used on the ADV7185 is of very high quality as it uses 128 phases to resample the video, giving 1/128 pixel resolution. The resampler is controlled by a sync detection block that calculates line length variations on the input video.

The final stage in the luminance path, before it is applied to an output formatter block, is a 2-line delay store that is used to compensate for delays in the chroma datapath when chroma comb filter is selected.

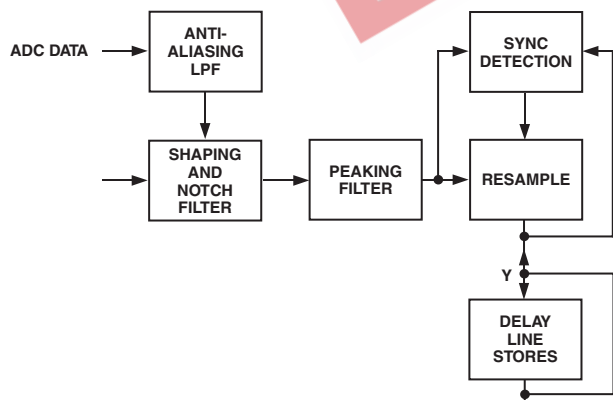

Figure 7. Luminance Processing Path

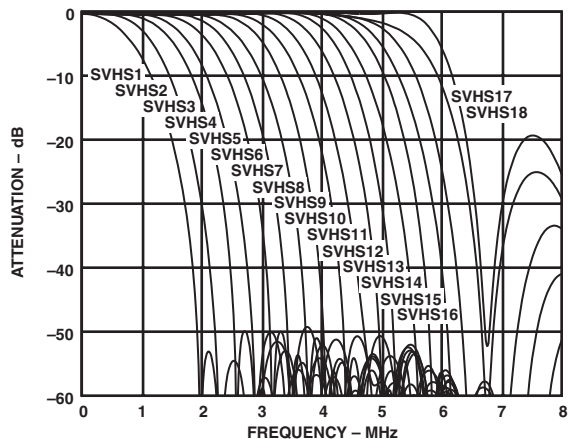

Figure 8. Luminance SVHS1-SVHS18 Shaping Filter Responses

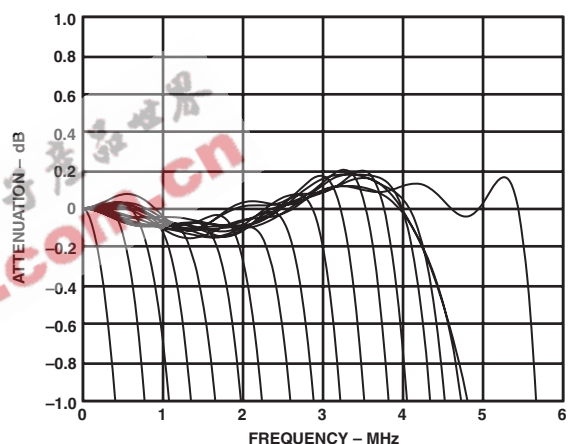

Figure 9. Luminance SVHS1-SVHS18 Shaping Filter Responses (Close-Up)

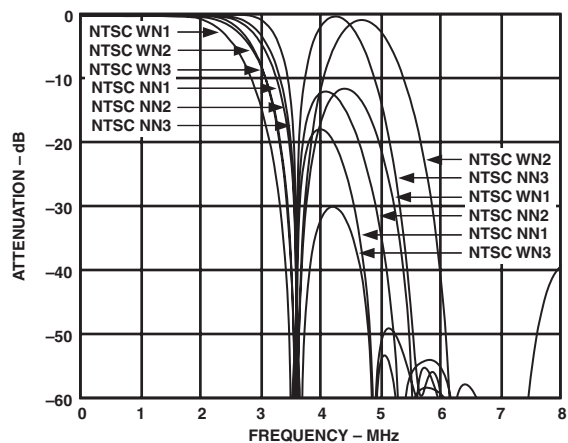

Figure 10. Luminance NTSC Narrow/Wide Notch Shaping Filter

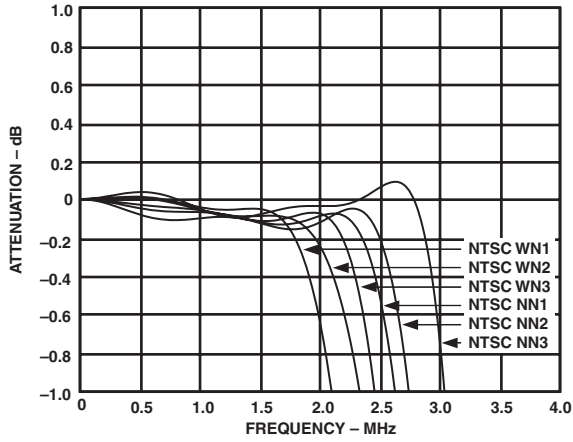

Figure 11. Luminance NTSC Narrow/Wide Notch Shaping Filter (Close-Up)

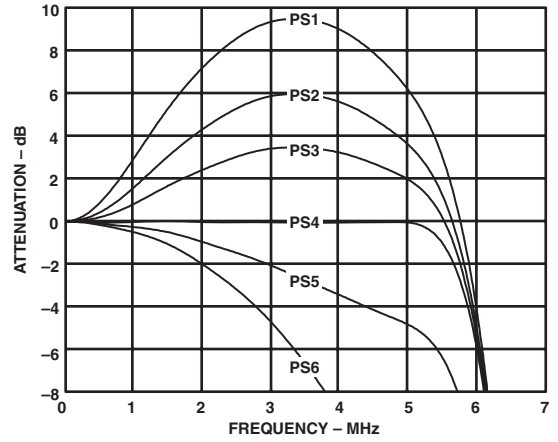

Figure 14. Luminance Peaking Filter Responses in S-Video (SVHS17 Selected)

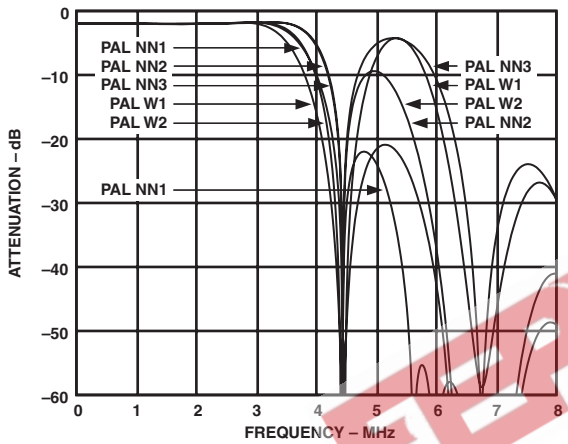

Figure 12. Luminance PAL Narrow/Wide Notch Shaping Filter Responses

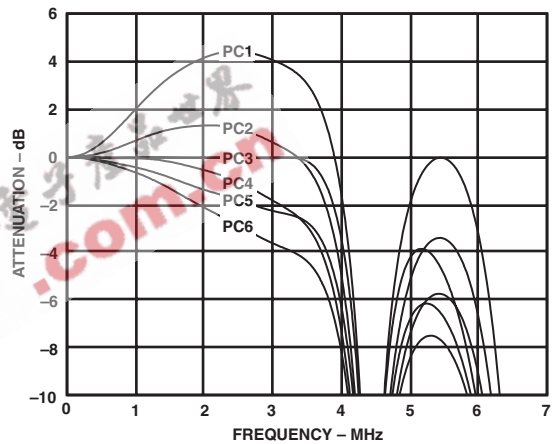

Figure 15. Luminance Peaking Filter Responses in CVBS (PAL NN3 Selected)

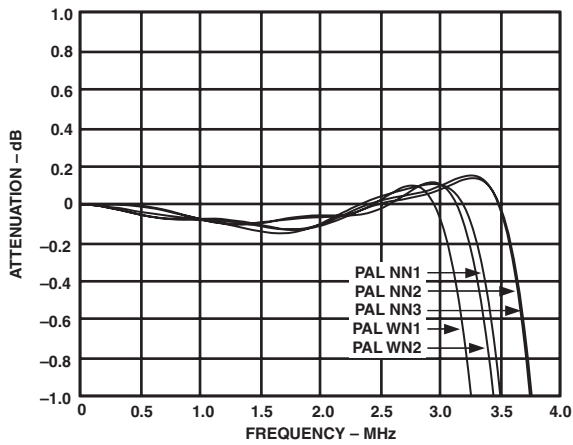

Figure 13. Luminance PAL Narrow/Wide Notch Shaping Filter Responses (Close-Up)

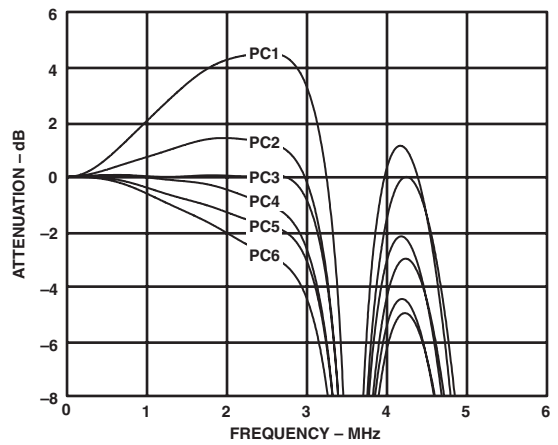

Figure 16. Luminance Peaking Filter Responses in CVBS (NTSC NN3 Selected)

CHROMINANCE PROCESSING

Figure 17 shows the chrominance data path. The 12-bit data from the Y ADC (CVBS mode) or the C ADC (S-video) is first demodulated. The demodulation is achieved by multiplying by the locally generated quadrature subcarrier, where the sign of the cos subcarrier is inverted from line to line according to the PAL switch, and then low-pass filtering is applied to removed components at twice the subcarrier frequency. For NTSC, the phase of the locally generated subcarrier during color burst is the same as the phase of the color burst. For PAL, the phase of the color burst changes from line to line, relative to the phase during active video, and the phase of the locally generated subcarrier is the average of these two values.

The chrominance data is then passed through an antialiasing filter, which is a band-pass filter to remove the unwanted luminance data. This antialiasing filter dramatically reduces the external antialiasing filter requirements as it has only to filter components above 25 MHz. In component mode, the demodulation block is bypassed.

The next stage of processing is a shaping filter that can be used to limit the chrominance bandwidth to between 0.5 MHz and 3 MHz; the CSFM[2:0] can be used to select these responses. It should be noted that in CVBS mode, a filter of no greater than 1.5 MHz should be selected as CVBS video is typically band-limited to below 1.5 MHz. In S-video mode, a filter of up to 2 MHz can be used. In component mode, a filter of up to 3 MHz can be used as component video has higher bandwidth than CVBS or S-video.

The chrominance data is then passed through a resampler to correct for line length variations in the input video. This resampler is designed to always output 720 pixels per line for standard PAL or NTSC. The resampler used on the ADV7185 is of very high quality as it uses 64 phases to resample the video, giving 1/64 pixel resolution. The resampler is controlled by a sync detection block that calculates line length variations on the input video.

The final stage in the chrominance path, before it is applied to an output formatter block, is chroma comb filter.

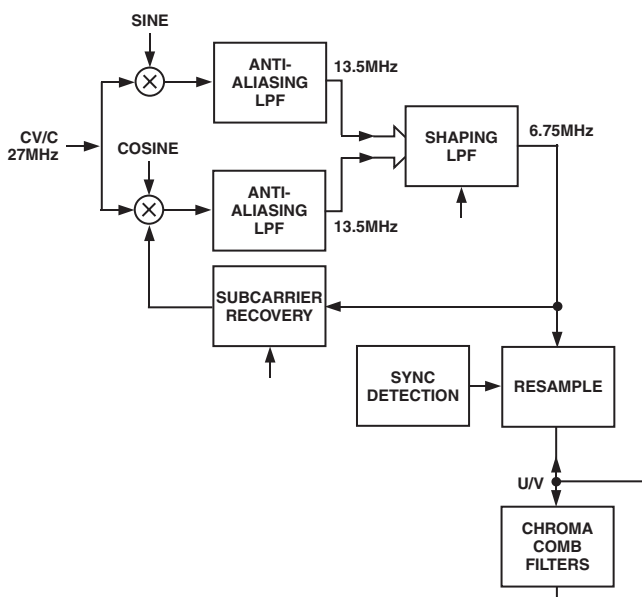

Figure 17. Chrominance Processing Path

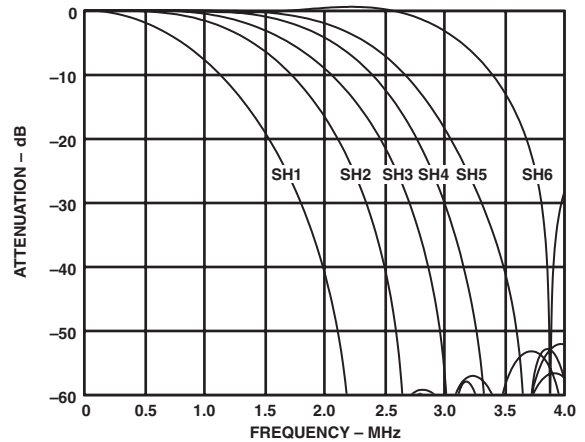

Figure 18. Chrominance Shaping Filter Responses

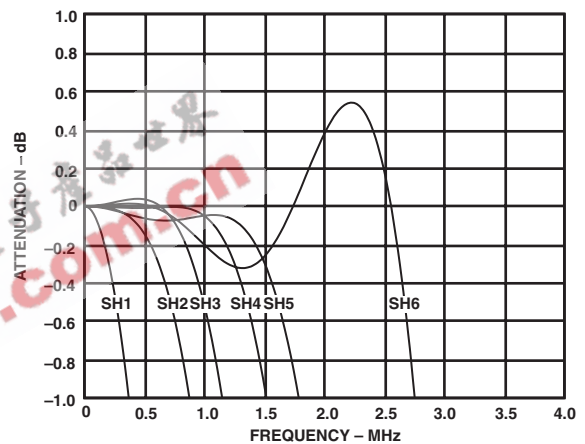

Figure 19. Chrominance Shaping Filter Responses (Close-Up)

ADV7185

OUTPUT INTERFACE

Mode Selection Overview

The ADV7185 supports three output interfaces: LLC-compatible synchronous pixel interface, the CAPI interface, and SCAPI interface. When the part is configured in the synchronous pixel interface mode, pixel and control data are output synchronous with LLC1 (8-bit or 10-bit mode) or LLC2 (16-bit or 20-bit mode). In this mode, control and timing information for field, vertical blanking, and horizontal blanking identification may also be encoded as control codes.

When configured in CAPI or SCAPI mode, only the active pixel data is output synchronous with the CLKIN (asynchronous FIFO clock). The pixels are output via a 512-pixel deep 20-bit wide FIFO. HACTIVE and VACTIVE are output on independent pins. HACTIVE will be active during the active viewable period of a video line and VACTIVE will be active during the active viewable period of a video field. CAPI and SCAPI modes will

always output data in 16-bit or 20-bit mode, so this mode of operation cannot be used when an 8-bit or 10-bit output interface is required. After power-up, the ADV7185 will default to the LLC-compatible 8-bit CCIR656 4:2:2 @ LLC.

Synchronous Pixel Interface

When the output is configured for an 8-bit pixel interface, the data is output on the pixel output port P[12:19]; 10-bit pixel interface uses P[13:19]. In this mode, 10/8 bits of chrominance data will precede 8/10 bits of luminance data. New pixel data is output on the pixel port after each rising edge of LLC1. When the output is configured for a 16-bit pixel interface, the luminance data is output on P[19:12] and the chrominance data on P[2:9]. In this mode the data is output with respect to LLC2. 20-bit pixel operation will use P[19:10] for luminance data and P[9:0] for chrominance data; as with the 16-bit mode data is output with respect to LLC2. Figure 20 shows the basic timing relationship for this mode.

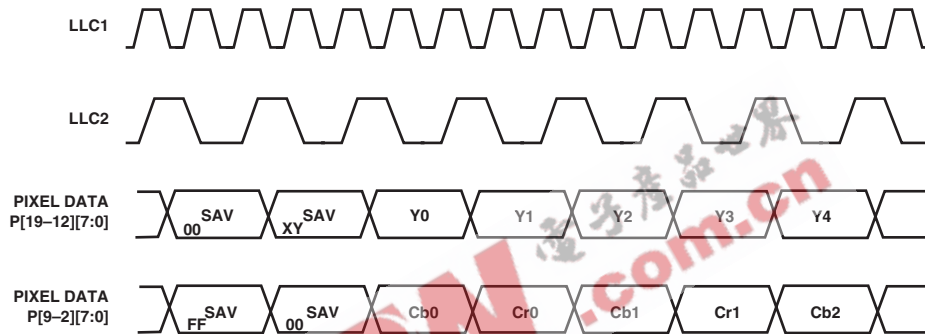

Figure 20. Synchronous Pixel Interface, 16-Bit Example

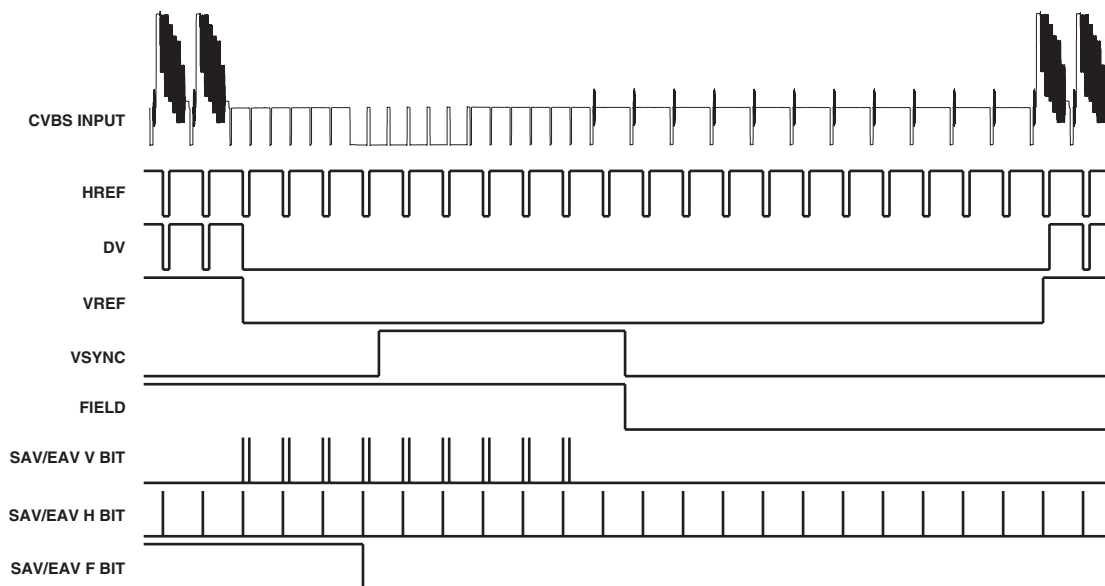

Figure 21. NTSC End Even Field (LLC Mode)

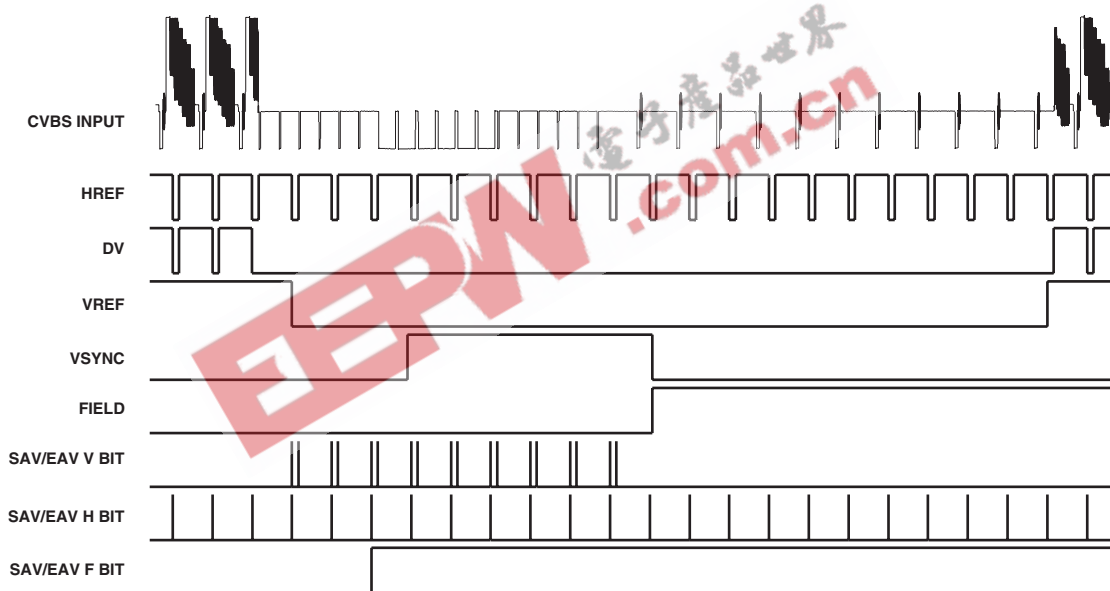

Figure 22. NTSC End Odd Field (LLC Mode)

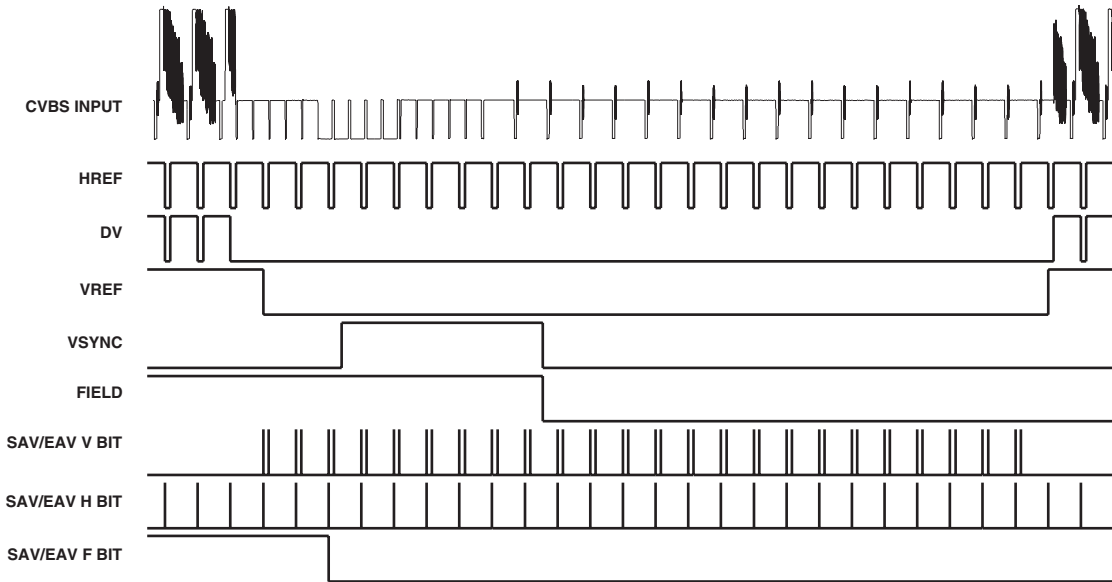

Figure 23. PAL End Even Field (LLC Mode)

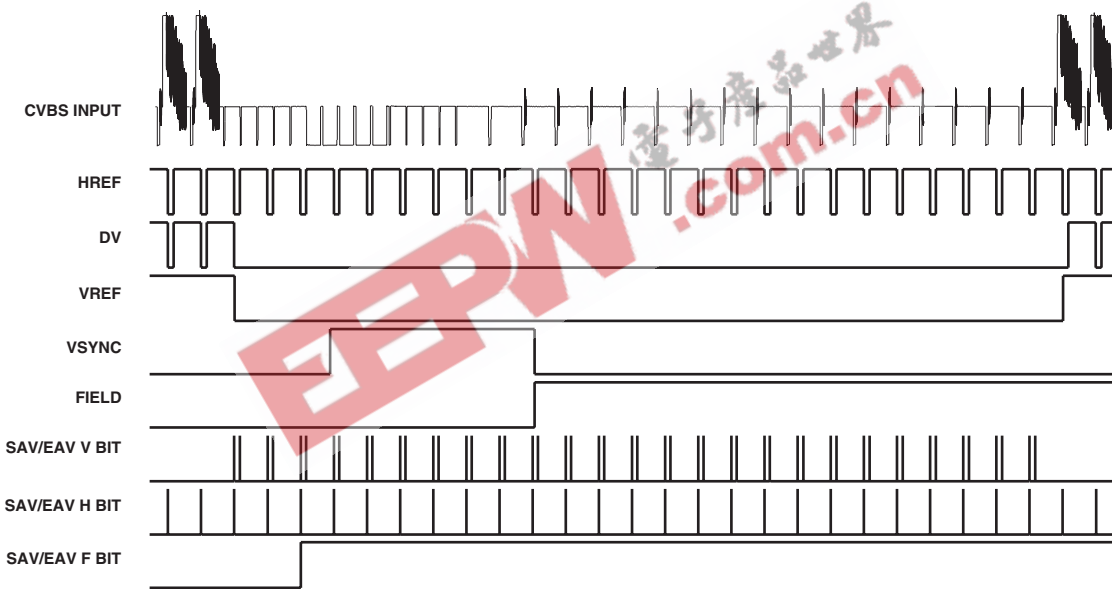

Figure 24. PAL End Odd Field (LLC Mode)

Control and Pixel Interface FIFO Modes

When the ADV7185 is configured to operate in this mode, pixel data generated within the part is buffered by a 512-pixel deep FIFO. Only active video pixels and control codes are written into the FIFO; the others have been dropped. In this mode, the output is operating asynchronously and a CLKIN must be provided to clock pixels out of the FIFO. The CLKIN must operate faster than the effective data transfer rate into the FIFO. This rate will be determined by the number of active pixels per line. If the CLKIN is not above this, the FIFO may overflow. The ADV7185 controls the FIFO when set to operate in SCAPI mode. DV (data valid) is internally fed back to the RD (read enable), unlike the synchronous pixel mode where DV will not indicate the validity of the current pixel and only acts as an indication of how much data is stored in the FIFO. DV will go high at the same time as AFF and remain high until the FIFO is empty.

By internally setting DV to RD, the system ensures that the FIFO never overflows. When using this mode, the status of data on the pixel outputs can be determined by two indicators, DV and QCLK. DV will go active two clock cycles (LLC1) before valid data appears on the bus. QCLK is a qualified clock derived from CLKIN, but will only be present when valid pixel data is output from the FIFO. DV indicates valid pixel or control code data. Using these two control signals, the user can differentiate between pixel information and invalid data. Figure 25 shows the basic timing relationship for this mode.

The operation of the ADV7185 in CAPI mode is similar to that of SCAPI mode with the exception that now the FIFO is controlled by the system; the system must monitor the almost full flag (AFF), the almost empty flag (AEF), and control the FIFO read enable (RD). Unlike SCAPI mode, the QCLK is not gated and is therefore continuous. Figure 26 shows the basic timing relationship of this mode.

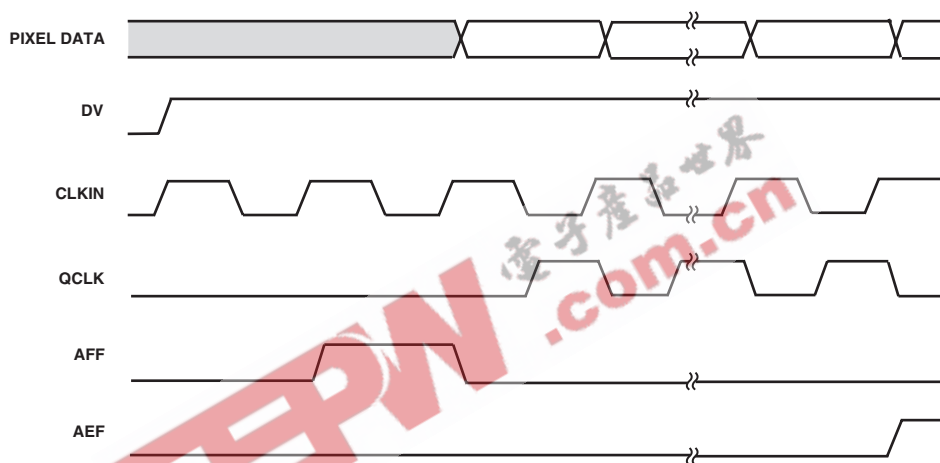

NOTES
 1. THE POLARITY OF AFF AND AEF ARE CONTROLLED BY THE PFF BIT.
 2. DV POLARITY IS SET BY THE PDV BIT.

Figure 25. SCAPI Output Mode FIFO Operation

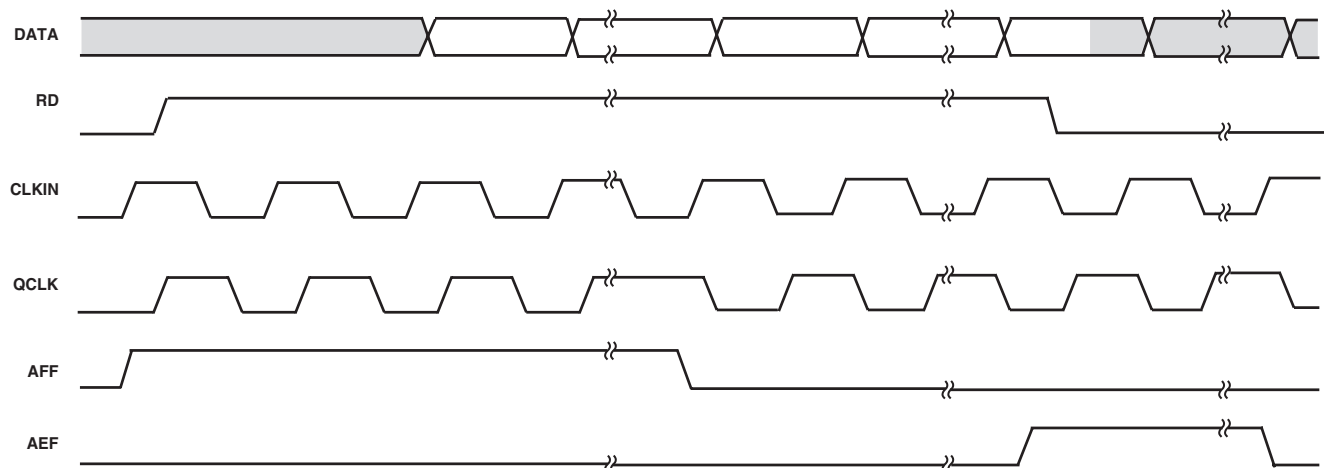

THE POLARITY OF AFF AND AEF ARE CONTROLLED BY THE PFF BIT.

Figure 26. CAPI Output Mode FIFO Operation

ADV7185

Manual Clock Control

The ADV7185 offers several output clock mode options: the output clock frequency can be set by the input video line length, a fixed 27 MHz output, or by a user-programmable value. Information on the clock control register at 28h can be found in the register access map. When Bit 6 of this register (CLKMANE) is set to Logic “1,” the output clock frequency will be determined by the user-programmable value (CLKVAL[15:0]). Using this mode, the output clock frequency is calculated as:

$$LLC = \frac{CLKVAL[17:0]}{2^{20}} \times 28 \times \frac{3}{16} \times 27 \text{ MHz}$$

For example, a required clock frequency of 25 MHz would yield a CLKVAL of 2D266h (184934).

Color Subcarrier Control

The color subcarrier manual frequency control register (CSMF[27:0]) can be used to set the DDFS block to a user-defined frequency. This function can be useful if the color subcarrier frequency of the incoming video signal is outside the standard F_{SC} lock range. Setting Bit 4 reg 23h (CSM) to a Logic “1” enables the manual frequency control, the frequency of which will be determined by CSMF[27:0]. The value of CSMF[27:0] can be calculated as:

$$CSMF[27:0] = F_{SC} * \times \frac{2^{28}}{27 \text{ MHz}}$$

*Required

MPU PORT DESCRIPTION

The ADV7185 supports a 2-wire serial (I²C-compatible) micro-processor bus driving multiple peripherals. Two inputs, serial data (SDATA) and serial clock (SCLOCK), carry information between any device connected to the bus. Each slave device is recognized by a unique address. The ADV7185 has two possible slave addresses for both read and write operations. These are unique addresses for the device and are illustrated in Figure 27. The LSB sets either a read or write operation. Logic Level “1” corresponds to a read operation while Logic Level “0” corresponds to a write operation. A1 is set by setting the ALSB pin of the ADV7185 to Logic Level “0” or Logic Level “1.”

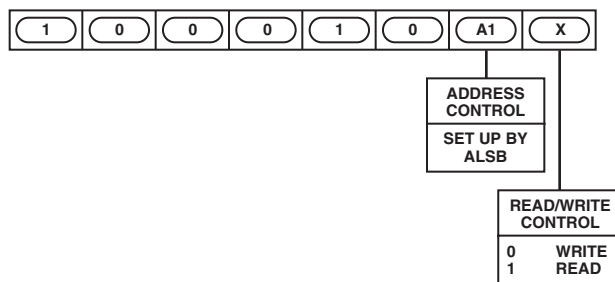

Figure 27. Slave Address

To control the device on the bus the following protocol must be followed. First the master initiates a data transfer by establishing a start condition, defined by a high to low transition on SDATA while SCLOCK remains high. This indicates that an address/data stream will follow. All peripherals respond to the start condition and shift the next 8 bits (7-Bit Address + R/\overline{W} Bit). The bits are transferred from MSB down to LSB. The peripheral that recognizes the transmitted address responds by pulling the data line low during the ninth clock pulse. This is known as an acknowledge bit. All other devices withdraw from the bus at this point and maintain an idle condition. The idle condition is where the device monitors the SDATA and SCLOCK lines waiting for the start condition and the correct transmitted address. The R/\overline{W} bit determines the direction of the data. A Logic “0” on the LSB of the first byte means that the master will write information to the peripheral. A Logic “1” on the LSB of the first byte means that the master will read information from the peripheral.

The ADV7185 acts as a standard slave device on the bus. The data on the SDATA pin is 8 bits long, supporting the 7-bit addresses plus the R/\overline{W} bit. The ADV7185 has 71 subaddresses to enable access to the internal registers. It therefore interprets the first byte as the device address and the second byte as the starting subaddress. The subaddresses autoincrement, allowing data to be written to or read from the starting subaddress. A data transfer is always terminated by a stop condition. The user can also access any unique subaddress register on a one-by-one basis, without having to update all the registers.

Stop and start conditions can be detected at any stage during the data transfer. If these conditions are asserted out of sequence with normal read and write operations, they cause an immediate jump to the idle condition. During a given SCLOCK high period, the user should only issue one start condition, one stop condition, or a single stop condition followed by a single start condition. If an invalid subaddress is issued by the user, the ADV7185 will not issue an acknowledge and will return to the idle condition. If the user exceeds the highest subaddress in autoincrement mode, the following action will be taken:

1. In read mode, the highest subaddress register contents will continue to be output until the master device issues a no-acknowledge. This indicates the end of a read. A no-acknowledge condition is where the SDATA line is not pulled low on the ninth pulse.
2. In write mode, the data for the invalid byte will not be loaded into any subaddress register, a no-acknowledge will be issued by the ADV7185, and the part will return to the idle condition.

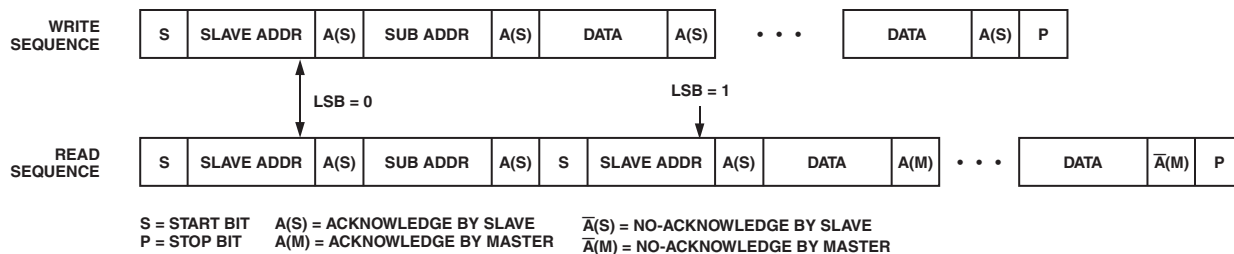

Figure 28. Write and Read Sequences

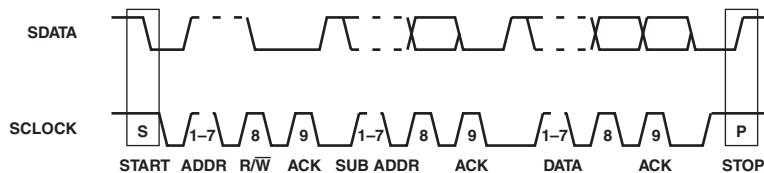

Figure 29. Bus Data Transfer

EEPW.com.cn 电子产品世界

ADV7185

REGISTER ACCESSES

The MPU can write to or read from all of the registers of the ADV7185 except the subaddress register, which is a write only register. The subaddress register determines which register the next read or write operation accesses. All communications with the part through the bus start with an access to the subaddress register. Then a read/write operation is performed from/to the target address, which then increments to the next address until a stop command on the bus is performed.

REGISTER PROGRAMMING

The following section describes each register in terms of its configuration.

Subaddress Register (SR7–SR0)

The communications register is an 8-bit write only register. After the part has been accessed over the bus and a read/write operation is selected, the subaddress is set up. The subaddress register determines to/from which register the operation takes place.

Table II shows the various operations under the control of the subaddress register. Zero should always be written to SR7–SR6.

Register Select (SR5–SR0)

These bits are set up to point to the required starting address.

Table II. Subaddress Register

Register Name	Addr (Hex)	Register Name	Addr (Hex)
BASIC BLOCK		ADVANCED BLOCK	
Input Control	00	Reserved	12
Video Selection	01	Analog Control (Internal)	13
Video Enhancement Control	02	Analog Clamp Control	14
Output Control	03	Digital Clamp Control 1	15
Extended Output Control	04	Digital Clamp Control 2	16
General-Purpose Output	05	Shaping Filter Control	17
Reserved	06	Reserved	18
FIFO Control	07	Comb Filter Control	19
Contrast Control	08	Reserved	1A
Saturation Control	09	Reserved	1B
Brightness Control	0A	Reserved	1C
Hue Control	0B	Reserved	1D
Default Value Y	0C	Reserved	1E
Default Value C	0D	Reserved	1F
Temporal Decimation	0E	Reserved	20
Power Management	0F	Reserved	21
Status Register	10	Reserved	22
Info Register	11	Color Subcarrier Control 1	23
		Color Subcarrier Control 2	24
		Color Subcarrier Control 3	25
		Color Subcarrier Control 4	26
		Pixel Delay Control	27
		Manual Clock Control 1	28
		Manual Clock Control 2	29
		Manual Clock Control 3	2A
		Auto Clock Control	2B
		AGC Mode Control	2C
		Chroma Gain Control 1	2D
		Chroma Gain Control 2	2E
		Luma Gain Control 1	2F
		Luma Gain Control 2	30
		Manual Gain Shadow Control 1	31
		Manual Gain Shadow Control 2	32
		Misc Gain Control	33
		HSync Position Control 1	34
		HSync Position Control 2	35
		HSync Position Control 3	36
		Polarity Control	37
		Reserved	44
		Reserved	45
		Reserved	F1
		Reserved	F2

Table III. Basic Registers

Register	Addr (Hex)	D7	D6	D5	D4	D3	D2	D1	D0
Input Control	00	VID SEL.3	VID SEL.2	VID SEL.1	VID SEL.0	INSEL.3	INSEL.2	INSEL.1	INSEL.0
Video Selection	01	ASE		BETACAM	4FSC	DIFFIN	SQPE	VID QUAL.1	VID QUAL.0
Video Enhancement Control	02				COR.1	COR.0	YPM.2	YPM.1	YPM.0
Output Control	03	VBI EN	TOD	OF SEL.3	OF SEL.2	OF SEL.1	OF SEL.0	OM SEL.1	OMEL.0
Extended Output Control	04	BT656-4							RANGE
General-Purpose Output	05	HL_EN	BL_C_VBI	GPEH	GPEL	GP0.3	GP0.2	GP0.1	GP0.0
Reserved	06								
FIFO Control	07	FFST	AFR	FR	FFM.4	FFM.3	FFM.2	FFM.1	FFM.0
Contrast Control	08	CON.7	CON.6	CON.5	CON.4	CON.3	CON.2	CON.1	CON.0
Saturation Control	09	SAT.7	SAT.6	SAT.5	SAT.4	SAT.3	SAT.2	SAT.1	SAT.0
Brightness Control	0A	BRI.7	BRI.6	BRI.5	BRI.4	BRI.3	BRI.2	BRI.1	BRI.0
Hue Control	0B	HUE.7	HUE.6	HUE.5	HUE.4	HUE.3	HUE.2	HUE.1	HUE.0
Default Value Y	0C	DEF Y.5	DEF Y.4	DEF Y.3	DEF Y.2	DEF Y.1	DEF Y.0	DEF_AUTO_EN	DEF_VAL_EN
Default Value C	0D	DEF C.7	DEF C.6	DEF C.5	DEF C.4	DEF C.3	DEF C.2	DEF C.1	DEF C.0
Temporal Decimation	0E		TDR.3	TDR.2	TDR.1	TDR.0	TDC.1	TDC.0	TDE
Power Management	0F	RES	TRAQ	PWRDN	PS CG	PS REF	PDBP	PSC.1	PSC.0
Status Register	10	STATUS.7	STATUS.6	STATUS.5	STATUS.4	STATUS.3	STATUS.2	STATUS.1	STATUS.0
Info Register	11	IDENT.7	IDENT.6	IDENT.5	IDENT.4	IDENT.3	IDENT.2	IDENT.1	IDENT.0

Table IV. Advanced Registers

Register	Addr (Hex)	D7	D6	D5	D4	D3	D2	D1	D0
Reserved	12								
Reserved	13							TIM_OE	
Analog Clamp Control	14			VCLEN	CCLEN	FACL.1	FACL.0	FICL.1	FICL.0
Digital Clamp Control 1	15	DCCM	DCT.1	DCT.0	DCFE	DCC0.11	DCC0.10	DCC0.9	DCC0.8
Digital Clamp Control 2	16	DCC0.7	DCC0.6	DCC0.5	DCC0.4	DCC0.3	DCC0.2	DCC0.1	DCC0.0
Shaping Filter Control	17	CSFM.2	CSFM.1	CSFM.0	YSFM.4	YSFM.3	YSFM.2	YSFM.1	YSFM.0
Reserved	18								
Comb Filter Control	19				CCMB_AD	CCM.1	CCM.0		
Color Subcarrier Control 1	23				CSM	CSMF.27	CSMF.26	CSMF.25	CSMF.24

ADV7185

Table IV. Advanced Registers (continued)

Register	Addr (Hex)	D7	D6	D5	D4	D3	D2	D1	D0
Color Subcarrier Control 2	24	CSMF.23	CSMF.22	CSMF.21	CSMF.20	CSMF.19	CSMF.18	CSMF.17	CSMF.16
Color Subcarrier Control 3	25	CSMF.15	CSMF.14	CSMF.13	CSMF.12	CSMF.11	CSMF.10	CSMF.9	CSMF.8
Color Subcarrier Control 4	26	CSMF.7	CSMF.6	CSMF.5	CSMF.4	CSMF.3	CSMF.2	CSMF.1	CSMF.0
Pixel Delay Control	27	SWPC		CTA.2	CTA.1	CTA.0			
Manual Clock Control 1	28	FIX27E	CLKMANE				CLKVAL.17	CLKVAL.16	
Manual Clock Control 2	29	CLKVAL.15	CLKVAL.14	CLKVAL.13	CLKVAL.12	CLKVAL.11	CLKVAL.10	CLKVAL.9	CLKVAL.8
Manual Clock Control 3	2A	CLKVAL.7	CLKVAL.6	CLKVAL.5	CLKVAL.4	CLKVAL.3	CLKVAL.2	CLKVAL.1	CLKVAL.0
Auto Clock Control	2B	ACKLM.2	ACKLM.1	ACKLM.0					
AGC Mode Control	2C		LAGC.2	LAGC.1	LAGC.0			CAGC.1	CAGC.0
Chroma Gain Control 1	2D	CAGT.1	CAGT.0			CMG.11	CMG.10	CMG.9	CMG.8
Chroma Gain Control 2	2E	CMG.7	CMG.6	CMG.5	CMG.4	CMG.3	CMG.2	CMG.1	CMG.0
Luma Gain Control 1	2F	LAGT.1	LAGT.0			LMG.11	LMG.10	LMG.9	LMG.8
Luma Gain Control 2	30	LMG.7	LMG.6	LMG.5	LMG.4	LMG.3	LMG.2	LMG.1	LMG.0
Manual Gain Shadow Control 1	31	SGUE				LMGS.11	LMGS.10	LMGS.9	LMGS.8
Manual Gain Shadow Control 2	32	LMGS.7	LMGS.6	LMGS.5	LMGS.4	LMGS.3	LMGS.2	LMGS.1	LMGS.0
Misc Gain Control	33		CKE		MIRE.2	MIRE.1	MIRE.0	AV_AL	PW_UPD
Hsync Position Control 1	34	HSB.9	HSB.8	HSE.9	HSE.8				
Hsync Position Control 2	35	HSB.7	HSB.6	HSB.5	HSB.4	HSB.3	HSB.2	HSB.1	HSB.0
Hsync Position Control 3	36	HSE.7	HSE.6	HSE.5	HSE.4	HSE.3	HSE.2	HSE.1	HSE.0
Polarity Control	37	PHS	PHVR	PVS	PLLCR	PF	PDV	PFF	PCLK
Resample Control	44		FSC_INV						
Reserved	45								
Reserved	F1								
Reserved	F2								

Table V. Input Control Register (Subaddress 00)

Bit Description	Bit 7	Bit 6	Bit 5	Bit 4	Bit 3	Bit 2	Bit 1	Bit 0	Register Setting
INSEL[3:0] ¹					0	0	0	0	CVBS In on AIN1 ²
					0	0	0	1	CVBS In on AIN2
					0	0	1	0	CVBS In on AIN3
					0	0	1	1	CVBS In on AIN4
					0	1	0	0	CVBS In on AIN5
					0	1	0	1	CVBS In on AIN6
					0	1	1	0	Y on AIN1, C on AIN4 ³
					0	1	1	1	Y on AIN2, C on AIN5
					1	0	0	0	Y on AIN3, C on AIN6
				1	0	0	1	Y on AIN1, U on AIN4, V on AIN5 ⁴	
				1	0	1	0	Y on AIN2, U on AIN3, V on AIN6	
VID_SEL[3:0] ⁵	0	0	0	0					Auto Detect PAL (BGHID), NTSC without Pedestal
	0	0	0	1					Auto Detect PAL (BGHID), NTSC (M) with Pedestal
	0	0	1	0					Auto Detect PAL (N), NTSC (M) without Pedestal
	0	0	1	1					Auto detect PAL (N), NTSC (M) with Pedestal
	0	1	0	0					NTSC (M) without Pedestal
	0	1	0	1					NTSC (M) with Pedestal
	0	1	1	0					NTSC 4.43 without Pedestal
	0	1	1	1					NTSC 4.43 with Pedestal
	1	0	0	0					PAL BGHID without Pedestal
	1	0	0	1					PAL N with Pedestal
	1	0	1	0					PAL M without Pedestal
	1	0	1	1					PAL M with Pedestal
1	1	0	0					PAL Combination N	
1	1	0	1					PAL Combination N with Pedestal	

NOTES

¹Allows the user to select an input channel as well as the input format.²Composite³S-Video⁴YUV⁵Allows the user to select the input video standard.

Table VI. Video Selection Register (Subaddress 01)

Bit Description	Bit 7	Bit 6	Bit 5	Bit 4	Bit 3	Bit 2	Bit 1	Bit 0	Register Setting
VID_QUAL[1:0] ¹							0	0	Broadcast Quality
							0	1	TV Quality
							1	0	VCR Quality
							1	1	Surveillance Quality
SQPE ²						0			Standard Mode
						1			Enable Square Pixel Mode
DIFFIN ³					0				Single-Ended Inputs
					1				Differential Inputs
FFSC ⁴				0					Standard Video Operation
				1					Select 4 F _{SC} Mode ⁵
BETACAM			0						Standard Video Input
			1						Betacam Input Enable
RESERVED		0							Set to Zero
ASE ⁶	1								INSEL change will not cause reacquire.
	0								INSEL change will trigger reacquire.

NOTES

¹Allows the user to influence the time constant of the system depending on the input video quality.²Allows the user to enable/disable the square pixel operation.³Allows the user to select a differential input mode for every entry in the INSEL[3:0] table.⁴4 F_{SC} Mode. Allows the selection of a special NTSC mode where the data is resampled to 4 F_{SC} sampling rate. As a result the LLC will operate at a 4 F_{SC} rate as well. Only valid for NTSC input.⁵NTSC only⁶Automatic Startup Enable. When set a change in the INSEL register will automatically be detected and lead the device to enter a video reacquire mode. May be disabled for genlocked video sources.

Table VII. Video Enhancement Control Register (Subaddress 02)

Bit Description	Bit 7	Bit 6	Bit 5	Bit 4	Bit 3	Bit 2	Bit 1	Bit 0	Register Setting
YPM[2:0] ¹						0	0	0	C = 4.5 dB, S = 9.25 dB ²
						0	0	1	C = 4.5 dB, S = 9.25 dB ³
						0	1	0	C = 4.5 dB, S = 5.75 dB
						0	1	1	C = 1.25 dB, S = 3.3 dB
						1	0	0	No Coring; C = 0, S = 0
						1	0	1	C = -1.25 dB, S = -3 dB
						1	1	0	C = -1.75 dB, S = -8 dB
COR[1:0] ⁴				0	0				No Coring
				0	1				Truncate if Y < black + 8
				1	0				Truncate if Y < black + 16
				1	1				Truncate if Y < black + 32
RESERVED	0	0	0						Set to Zero

NOTES

¹Y Peaking Filter Mode. Allows the user to boost/attenuate luma signals around the color subcarrier frequency. Used to enhance the picture and improve the contrast.

²C = Composite (2.6 MHz)

³S = S-Video (3.75 MHz)

⁴Coring Selection. Controls optional coring of the Y output signal depending on its level.

Table VIII. Output Control Register (Subaddress 03)

Bit Description	Bit 7	Bit 6	Bit 5	Bit 4	Bit 3	Bit 2	Bit 1	Bit 0	Register Setting
OM_SEL[1:0] ¹							0	0	Philips-Compatible
							0	1	Broktree API A-Compatible
							1	0	Broktree API B-Compatible
							1	1	Not Valid Setting
OF_SEL[3:0] ²			0	0	0	0			10-bit @ LLC 4:2:2 CCIR656
			0	0	0	1			20-bit @ LLC2 4:2:2 CCIR656
			0	0	1	0			16-bit @ LLC2 4:2:2 CCIR656
			0	0	1	1			8-bit @ LLC 4:2:2 CCIR656
			0	1	0	0			12-bit @ LLC2 4:1:1
			0	1	0	1			Not Used
			0	1	1	0			Not Used
			0	1	1	1			Not Used
			1	0	0	0			Not Used
			1	0	0	1			Not Used
			1	0	1	0			Not Used
			1	0	1	1			Not Used
			1	1	0	0			Not Used
			1	1	1	0			Not Used
TOD ³		0							Drivers Dependent on \overline{OE} Pin
		1							Drivers Three-States Regardless of \overline{OE} Pin
VBI_EN ⁴	0								All Lines Filtered and Scaled
	1								Active Video Region Only

NOTES

¹Output Mode Selection. Selects the output mode as in the timing and interface type.

²Allows the user to choose from a set of output formats.

³Three-State Output Drivers. Allows the user to three-state the output drivers regardless of the state of the \overline{OE} pin.

⁴Allows VBI data (lines 1 to 21) to be passed through with only a minimum amount of filtering performed.

Table IX. Extended Output Control Register (Subaddress 04)

Bit Description	Bit 7	Bit 6	Bit 5	Bit 4	Bit 3	Bit 2	Bit 1	Bit 0	Register Setting
RANGE ¹								0	CCIR-Compliant
								1	Fill Whole Accessible Range
RESERVED					1	1	0		
DDOS[2:0] ²		0	0	0					No Additional Data ³
BT656-4 ⁴	0								BT656-3-Compatible
	1								BT656-4-Compatible

NOTES

¹Allows the user to select the range of output values. Can be CCIR601-compliant or fill the whole accessible number range.

²D Data Output Selection. If the 100-pin package is used, the 12 additional pins can output additional data.

³12 Pins Three-State

⁴Allows the user to select an output mode that is compatible with BT656-4 or BT656-3.

Table X. General-Purpose Output Register (Subaddress 05)

Bit Description	Bit 7	Bit 6	Bit 5	Bit 4	Bit 3	Bit 2	Bit 1	Bit 0	Register Setting
GPO[3:0] ¹					0	0	0	0	User Programmable
									Pixel Data Valid Off
GPEL ²				0					GPO[1:0] Three-States
			1						GPO[1:0] Enabled
GPEH ³				0					GPO[3:2] Three-States
			1						GPO[3:2] Enabled
BL_C_VBI ⁴		0							Decode and Output Color During VBI
		1							Blank Cr and Cb Data During VBI
HL_EN ^{5,6}	0								GPO[0] Pin Function
	1								GPO[0] Shows HLOCK Status

NOTES

¹Pixel Data Valid Off. These general-purpose output pins may be programmed by the user but are only available in selected output modes OF_SEL[3:0] and when the output drivers are enabled using GPEL, GPEH, and HL_Enable bits.

²General-Purpose Enable Low. Enables the output drivers for the general-purpose outputs Bits 0 and 1.

³General-Purpose Enable High. Enables the output drivers for the general-purpose outputs Bits 2 and 3.

⁴Blank Chroma during VBI.

⁵Hlock Enable. This bit causes the GPO[0] pin to output Hlock instead of GPO[0]. Only available in certain output modes.

⁶GPO lower bits must be enabled GPEL. Disabled.

Table XI. FIFO Control Register (Subaddress 07)

Bit Description	Bit 7	Bit 6	Bit 5	Bit 4	Bit 3	Bit 2	Bit 1	Bit 0	Register Setting
FFM[4:0] ¹				0	0	1	0	0	User-Programmable
FR ²			0						Normal Operation
			1						FIFO Reset ³
AFR ⁴		0							No Auto Reset
		1							Auto Reset
FFST ⁵	0								Synchronous to CLKIN
	1								Synchronous to 27 MHz

NOTES

¹FIFO Flag Margin. Allows the user to program the location at which the FIFO flags AEF and AFF.

²FIFO Reset. Setting this bit will cause the FIFO to reset.

³Bit is auto-cleared.

⁴Automatic FIFO Reset. Setting this bit will cause the FIFO to automatically reset at the end of each field of video.

⁵FIFO Flag Self Time. Sets whether the FIFO flags AEF, AFF, and HFF are output synchronous to the external CLKIN of the 27 MHz internal clock.

Table XII. Contrast Register (Subaddress 08)

Bit Description	Bit 7	Bit 6	Bit 5	Bit 4	Bit 3	Bit 2	Bit 1	Bit 0	Register Setting
CON[7:0]*	1	0	0	0	0	0	0	0	

*Contrast Adjust. This is the user control for contrast adjustment.

Table XIII. Saturation Register (Subaddress 09)

Bit Description	Bit 7	Bit 6	Bit 5	Bit 4	Bit 3	Bit 2	Bit 1	Bit 0	Register Setting
SAT[7:0]*	0	0	0	0	0	0	0	0	-42 dB
	1	0	0	0	0	0	0	0	0 dB
	1	1	1	1	1	1	1	1	6 dB

*Saturation Adjust. Allows the user to adjust the saturation of color output.

Table XIV. Brightness Register (Subaddress 0A)

Bit Description	Bit 7	Bit 6	Bit 5	Bit 4	Bit 3	Bit 2	Bit 1	Bit 0	Register Setting
BRI[7:0]*	0	0	0	0	0	0	0	0	0 dB
	0	1	1	1	1	1	1	1	3 dB
	1	0	0	0	0	0	0	0	-3 dB

*Controls the brightness of the video signal. Range = ± 3 dB.

Table XV. Hue Register (Subaddress 0B)

Bit Description	Bit 7	Bit 6	Bit 5	Bit 4	Bit 3	Bit 2	Bit 1	Bit 0	Register Setting
HUE[7:0]*	0	0	0	0	0	0	0	0	0°
	0	1	1	1	1	1	1	1	90°
	1	0	0	0	0	0	0	0	-90°

*Contains the value for the color hue adjustment. Range = $\pm 90^\circ$.

Table XVI. Default Value Y Register (Subaddress 0C)

Bit Description	Bit 7	Bit 6	Bit 5	Bit 4	Bit 3	Bit 2	Bit 1	Bit 0	Register Setting
DEF_VAL_EN ¹								0	Use Programmed Value ²
								1	Use Default Value
DEF_VAL_AUTO_EN ³							0		Use Programmed Value ⁴
							1		Use Default Value
DEF_Y[5:0] ⁵	0	0	0	1	0	0			

NOTES

¹Default Value Enable

²Y, Cr, and Cb Values

³Default Value Auto Enable. In the case of lost lock enables/disables default values.

⁴When lock is lost.

⁵Default Value Y. Holds the Y default value.

Table XVII. Default Value C Register (Subaddress 0D)

Bit Description	Bit 7	Bit 6	Bit 5	Bit 4	Bit 3	Bit 2	Bit 1	Bit 0	Register Setting
DEF_C[7:0]*					1	0	0	0	Cr[7:0] = {DEF_C[7:4], 0, 0, 0, 0}
	1	0	0	0					Cb[7:0] = {DEF_C[3:0], 0, 0, 0, 0}

*Default Value C. Cr and Cb default values are defined in this register.

Table XVIII. Temporal Decimation Register (Subaddress 0E)

Bit Description	Bit 7	Bit 6	Bit 5	Bit 4	Bit 3	Bit 2	Bit 1	Bit 0	Register Setting
TDE ¹								0	Disabled
								1	Enabled
TDC[1:0] ²						0	0		Suppress Frames; Start with Even Field
						0	1		Suppress Frames; Start with Odd Field
						1	0		Suppress Even Fields Only
						1	1		Suppress Odd Fields Only
TDR[3:0] ³		0	0	0	0				Skip None
		0	0	0	1				Skip 1 Field/Frame
		0	0	1	0				Skip 2 Fields/Frames
		0	0	1	1				Skip 3 Fields/Frames
		0	1	0	0				Skip 4 Fields/Frames
		0	1	0	1				Skip 5 Fields/Frames
		0	1	1	0				Skip 6 Fields/Frames
		0	1	1	1				Skip 7 Fields/Frames
		1	0	0	0				Skip 8 Fields/Frames
		1	0	0	1				Skip 9 Fields/Frames
		1	0	1	0				Skip 10 Fields/Frames
		1	0	1	1				Skip 11 Fields/Frames
		1	1	0	0				Skip 12 Fields/Frames
		1	1	0	1				Skip 13 Fields/Frames
		1	1	1	0				Skip 14 Fields/Frames
	1	1	1	1				Skip 15 Fields/Frames	
RESERVED	0								Set to Zero

NOTES

¹Temporal Decimation Enable. Allows the user to enable/disable the temporal function. Configured using TDC[1:0] and TDR[3:0].

²Temporal Decimation Control. Allows the user to select the suppression of selected fields of video.

³Temporal Decimation Rate. Specifies how many fields/frames to be skipped before a valid one is output. As specified in the TDC[1:0] register.

Table XIX. Power Management Register (Subaddress 0F)

Bit Description	Bit 7	Bit 6	Bit 5	Bit 4	Bit 3	Bit 2	Bit 1	Bit 0	Register Setting
PSC[1:0] ¹							0	0	Full Operation
							0	1	CVBS Input Only
							1	0	Digital Only
							1	1	Power Save Mode
PDBP ²						0			Power-Down Controller by Pin
						1			Power-Down Controller by Bit
PS_REF ³					0				Reference Functional
					1				Reference in Power Save Mode
PS_CG ⁴				0					Clock Generator Functional
				1					CG in Power Save Mode
PWRDN ⁵			0						System Functional
			1						Power-Down
TRAQ ⁶		0							Normal Operation
		1							Require Video Signal
RESET ⁷	0								
	1								Resets Digital Core and I ² C

NOTES

¹Power Save Control. Allows a set of different power save modes to be selected.

²Power-Down Bit Priority. There are two ways to shut down the digital core; the Power-Down Bit sets which has higher priority.

³Power Save Reference. Allows the user to enable/disable the internal analog reference.

⁴Power Save for the LLC Clock Generator

⁵Power-Down. Disables the input pads and powers down the 27 MHz clock.

⁶Timing Reacquire. Will cause the part to reacquire the video signal and is the software version of the ISO pin. If bit is set will clear itself on the next 27 MHz clock cycle.

⁷Resets Digital Core and I²C; self-clearing bit.

Table XXIV. Digital Clamp Control 1 Register (Subaddress 15)

Bit Description	Bit 7	Bit 6	Bit 5	Bit 4	Bit 3	Bit 2	Bit 1	Bit 0	Register Setting
DCCO[11:8] ¹					X	X	X	X	Only applicable if DCCM is set to manual offset mode.
DCFE ²				0					Digital Clamp Operational
				1					Digital Clamp Frozen
DCT[1:0] ³		0	0						Slow (TC = 1 second)
		0	1						Medium (TC = 0.5 second)
		1	0						Fast (TC = 0.1 second)
		1	1						Dependent on VID_QUAL
DCCM[7:0] ⁴	0								Automatic Digital Clamp
	1								Manual Offset Correction

NOTES

¹(Digital Color Clamp Offset) Holds upper 4 bits of the digital offset value which is added to the raw data from the ADC before entering the core.

²(Digital Clamp Freeze Enable) Allows the user to freeze the digital clamp loop at any point in time.

³(Digital Clamp Timing) Determines the time constant of the digital clamping circuitry.

⁴(Digital Color Clamp Mode) Sets the mode of operation for the digital clamp circuitry. Offset correction via DCCO for C only.

Table XXV. Digital Clamp Control 2 Register (Subaddress 16)

Bit Description	Bit 7	Bit 6	Bit 5	Bit 4	Bit 3	Bit 2	Bit 1	Bit 0	Register Setting
DCCO[7:0]*	X	X	X	X	X	X	X	X	

*Digital Color Clamp Offset. Holds the lower 8 bits of the digital offset value which is added to the raw data from the ADC before entering the core. Only applicable if DCCM is set to manual offset mode.

Table XXVI. Shaping Filter Control Register (Subaddress 17)

Bit Description	Bit 7	Bit 6	Bit 5	Bit 4	Bit 3	Bit 2	Bit 1	Bit 0	Register Setting
YSFM[4:0] ¹				0	0	0	0	0	Auto Wide Notch
				0	0	0	0	1	Auto Narrow Notch
				0	0	0	1	0	SVHS 1
				-	-	-	-	-	-
				1	0	0	1	0	SVHS 17
				1	0	0	1	1	PAL NN1
				1	0	1	0	0	PAL NN2
				1	0	1	0	1	PAL NN3
				1	0	1	1	0	PAL WN 1
				1	0	1	1	1	PAL WN 2
				1	1	0	0	0	NTSC NN1
				1	1	0	0	1	NTSC NN2
				1	1	0	1	0	NTSC NN3
				1	1	0	1	1	NTSC WN1
				1	1	1	0	0	NTSC WN2
			1	1	1	0	1	NTSC WN3	
			1	1	1	1	0	Not Used	
			1	1	1	1	1	SVHS 18	
CSFM[2:0] ²	0	0	0						Auto Selection 1.5 MHz
	0	0	1						Auto Selection 2.17 MHz
	0	1	0						SH1
	-	-	-						-
	1	1	0						SH5
	1	1	1						SH6

NOTES

¹Y Shaping Filter Mode. Allows the user to select a wide range of low-pass and notch filters.

²C Shaping Filter Mode. Allows the selection from a range of low-pass chrominance filters. Auto = filter selected based on scaling factor.

Table XXVII. Comb Filter Control Register (Subaddress 19)

Bit Description	Bit 7	Bit 6	Bit 5	Bit 4	Bit 3	Bit 2	Bit 1	Bit 0	Register Setting
RESERVED	0	0	0				0	0	Set to Zero
CCM[1:0] ¹					0	0			No Comb
					0	1			1H
					1	0			2H
					1	1			Not Valid, Do Not Use
CCMB_AD ²				0					Chroma Comb Nonadaptive
				1					Chroma Comb Adaptive

NOTES

¹Chroma Comb Mode. Selects a primary mode for the filter.

²Chroma Comb Adaptive

Table XXVIII. Color Subcarrier Control 1 Register (Subaddress 23)

Bit Description	Bit 7	Bit 6	Bit 5	Bit 4	Bit 3	Bit 2	Bit 1	Bit 0	Register Setting
CSMF[27:24] ¹					X	X	X	X	
CSM ²				0					Manual FSC Disabled
				1					User-Defined FSC ³
RESERVED	1	1	1						Set to One

NOTES

¹Color Subcarrier Manual Frequency. Holds the value used to enable the user to support odd subcarrier frequencies.

²Color Subcarrier Manual

³Defined in CSFM[27:0]

Table XXIX. Color Subcarrier Control 2 Register (Subaddress 24)

Bit Description	Bit 7	Bit 6	Bit 5	Bit 4	Bit 3	Bit 2	Bit 1	Bit 0	Register Setting
CSMF[23:16]*	X	X	X	X	X	X	X	X	

*Color Subcarrier Manual Frequency. Holds the value used to enable the user to support odd subcarrier frequencies.

Table XXX. Color Subcarrier Control 3 Register (Subaddress 25)

Bit Description	Bit 7	Bit 6	Bit 5	Bit 4	Bit 3	Bit 2	Bit 1	Bit 0	Register Setting
CSMF[15:8]*	X	X	X	X	X	X	X	X	

*Color Subcarrier Manual Frequency. Holds the value used to enable the user to support odd subcarrier frequencies.

Table XXXI. Color Subcarrier Control 4 Register (Subaddress 26)

Bit Description	Bit 7	Bit 6	Bit 5	Bit 4	Bit 3	Bit 2	Bit 1	Bit 0	Register Setting
CSMF[7:0]*	X	X	X	X	X	X	X	X	

*Color Subcarrier Manual Frequency. Holds the value used to enable the user to support odd subcarrier frequencies.

Table XXXII. Pixel Delay Control Register (Subaddress 27)

Bit Description	Bit 7	Bit 6	Bit 5	Bit 4	Bit 3	Bit 2	Bit 1	Bit 0	Register Setting
RESERVED						0	0	0	Set to Zero
CTA[2:0] ¹			0	0	0				Not Valid
			0	0	1				Chroma + 2 Pixel (Early)
			0	1	0				Chroma + 1 Pixel (Early)
			0	1	1				No Delay
			1	0	0				Chroma - 1 Pixel (Late)
			1	0	1				Chroma - 2 Pixel (Late)
			1	1	0				Chroma - 3 Pixel (Late)
RESERVED		1							Set to One
SWPC ²	0								No Swapping
	1								Swap the Cr and Cb Values

NOTES

¹Chroma Timing Adjust. Allows a specified timing difference between the luma and chroma samples.

²Allows the Cr and Cb samples to be swapped.

Table XXXIII. Manual Clock Control 1 Register (Subaddress 28)

Bit Description	Bit 7	Bit 6	Bit 5	Bit 4	Bit 3	Bit 2	Bit 1	Bit 0	Register Setting
CLKVAL[17:16] ¹							X	X	
RESERVED			1	1	1	1			Set to Default
CLKMANE ²		0							Output Frequency Set by Video
		1							Frequency Set by CLKVAL[17:0]
FIX27E ³		0							Output Frequency Set by Clock Generator
		1							Output 27 MHz Fixed

NOTES

¹If enabled via CLKMANE, CLKVAL[17:0] determines the fixed output frequency. On the LLC, LLC2, and LLCREF pins.

²Clock Generator Manual Enable. Allows the analog clock generator to produce a fixed clock frequency that is not dependent on the video signal.

³Allows the o/p of fixed 27 MHz crystal clock via LLC, LLC2, and LLCREF o/p pins.

Table XXXIV. Manual Clock Control 2 Register (Subaddress 29)

Bit Description	Bit 7	Bit 6	Bit 5	Bit 4	Bit 3	Bit 2	Bit 1	Bit 0	Register Setting
CLKVAL[15:8]*	X	X	X	X	X	X	X	X	

*If enabled via CLKMANE, CLKVAL[17:0] determines the fixed output frequency. On the LLC, LLC2, and LLCREF pins.

Table XXXV. Manual Clock Control 3 Register (Subaddress 2A)

Bit Description	Bit 7	Bit 6	Bit 5	Bit 4	Bit 3	Bit 2	Bit 1	Bit 0	Register Setting
CLKVAL[7:0]*	X	X	X	X	X	X	X	X	

*If enabled via CLKMANE, CLKVAL[17:0] determines the fixed output frequency. On the LLC, LLC2, and LLCREF pins.

Table XXXVI. Auto Clock Control Register (Subaddress 2B)

Bit Description	Bit 7	Bit 6	Bit 5	Bit 4	Bit 3	Bit 2	Bit 1	Bit 0	Register Setting
RESERVED				0	0	0	0	0	Set to Zero
ACLKN[2:0]*	0	0	0						Color Burst Line
	0	0	1						Start Line 24 Color Burst Line
	0	1	0						Active Video
	0	1	1						Active Video (<304) PAL, (<264) NTSC
	1	0	0						Active Video (<304) PAL, (<256) NTSC
	1	0	1						Active Video (<319/320) PAL, (<273/274) NTSC
	1	1	0						Invalid
	1	1	1						Invalid

*Automatic Clock Generator Mode. Influences the mode of operation for the LLC. Only when not in Manual Mode.

Table XXXVII. AGC Mode Control Register (Subaddress 2C)

Bit Description	Bit 7	Bit 6	Bit 5	Bit 4	Bit 3	Bit 2	Bit 1	Bit 0	Register Setting
CAGC[1:0] ¹							0	0	Manual Fixed Gain. Use CMG [11:0]
							0	1	Use Luma Gain for Chroma
							1	0	Automatic Gain. Based on color burst
							1	1	Freeze Chroma Gain
RESERVED				1	1				Set to One
LAGC[2:0] ²		0	0	0					Manual Fixed Gain ³
		0	0	1					AGC No Override through White Peak; Man IRE Control ⁴
		0	1	0					AGC Auto Override through White Peak; Man IRE Control ⁴
		0	1	1					AGC No Override through White Peak; Man IRE Control ⁴
		1	0	0					AGC Auto Override through White Peak; Man IRE Control ⁴
		1	0	1					AGC Active Video with White Peak
		1	1	0					AGC Active Video with Average Video
		1	1	1					Freeze Gain
RESERVED	1								Set to One

NOTES

¹Chroma Automatic Gain Control. Selects the basic mode of operation for the AGC in the chroma path.

²Luma Automatic Gain Control. Selects the mode of operation for the gain control in the luma path.

³Use LMG[11:0].

⁴Blank level to sync tip.

Table XXXVIII. Chroma Gain Control 1 Register (Subaddress 2D)

Bit Description	Bit 7	Bit 6	Bit 5	Bit 4	Bit 3	Bit 2	Bit 1	Bit 0	Register Setting
CMG[11:8] ¹					X	X	X	X	
RESERVED			1	1					Set to One
CAGT[1:0] ²	0	0							Slow (TC = 2 sec)
	0	1							Medium (TC = 1 sec)
	1	0							Fast (TC = 0.2 sec)
	1	1							Dependent on VID_QUAL

NOTES

¹Chroma Manual Gain. Can be used to program a desired manual chroma gain or read back the actual used gain value. CAGC[1:0] settings will decide in which mode CMG[11:0] will operate.

²Chroma Automatic Gain Timing. Allows adjustment of the Chroma AGC tracking speed. Will only have effect if CAGC[1:0] is set to auto gain (10b).

Table XXXIX. Chroma Gain Control 2 Register (Subaddress 2E)

Bit Description	Bit 7	Bit 6	Bit 5	Bit 4	Bit 3	Bit 2	Bit 1	Bit 0	Register Setting
CMG[7:0]*	X	X	X	X	X	X	X	X	

*Chroma Manual Gain. Lower 8 bits, see CMG [11:8] for description.

Table XL. Luma Gain Control 1 Register (Subaddress 2F)

Bit Description	Bit 7	Bit 6	Bit 5	Bit 4	Bit 3	Bit 2	Bit 1	Bit 0	Register Setting
LMG[11:8] ¹					X	X	X	X	
RESERVED			1	1					Set to One
LAGT[1:0] ²	0	0							Slow (TC = 2 sec)
	0	1							Medium (TC = 1 sec)
	1	0							Fast (TC = 0.2 sec)
	1	1							Dependent on VID_QUAL

NOTES

¹Luma Manual Gain. Can be used to program a desired manual chroma gain or read back the actual used gain value. LAGC[1:0] settings will decide in which mode LMG[11:0] will operate.

²Luma Automatic Gain Timing. Allows adjustment of the Luma AGC tracking speed. Will only have effect if LAGC[1:0] is set to auto gain (10b).

Table XLI. Luma Gain Control 2 Register (Subaddress 30)

Bit Description	Bit 7	Bit 6	Bit 5	Bit 4	Bit 3	Bit 2	Bit 1	Bit 0	Register Setting
LMG[7:0]*	X	X	X	X	X	X	X	X	

*Luma Manual Gain. Can be used to program a desired manual chroma gain or read back the actual used gain value.

Table XLII. Manual Gain Shadow Control 1 Register (Subaddress 31)

Bit Description	Bit 7	Bit 6	Bit 5	Bit 4	Bit 3	Bit 2	Bit 1	Bit 0	Register Setting
LMGS[11:8] ¹					X	X	X	X	
RESERVED		1	1	1					Set to One
SGUE ²	0								Disable LMGS Update
	1								Use LMGS Update Facility

NOTES

¹Luma Manual Gain Store. Has dual functions; a desired manual luma gain can be programmed or a readback from the register will return the actual gain used. Gain value will only become active when LAGC[2:0] set to manual fixed gain. The function and readback value are dependent on LAGC[2:0] setting.

²Surveillance Gain Update Enable. Enables surveillance mode operation (see LMGS[11:0] for details).

Table XLIII. Manual Gain Shadow Control 2 Register (Subaddress 32)

Bit Description	Bit 7	Bit 6	Bit 5	Bit 4	Bit 3	Bit 2	Bit 1	Bit 0	Register Setting
LMG[7:0]*	X	X	X	X	X	X	X	X	

*Chroma Manual Gain. Lower 8 bits, see LMG[11:8] for description.

Table XLIV. Miscellaneous Gain Control Register (Subaddress 33)

Bit Description	Bit 7	Bit 6	Bit 5	Bit 4	Bit 3	Bit 2	Bit 1	Bit 0	Register Setting
PW_UPD ¹								0	Update Gain Once per Line
								1	Update Gain Once per Field
AV_AL ²							0		Lines 33 to 310
							1		Lines 33 to 270
MIRE[2:0] ³				0	0	0			PAL-133 NTSC-122
				0	0	1			PAL-125 NTSC-115
				0	1	0			PAL-120 NTSC-110
				0	1	1			PAL-115 NTSC-105
				1	0	0			PAL-110 NTSC-100
				1	0	1			PAL-105 NTSC-100
				1	1	0			PAL-100 NTSC-100
				1	1	1			PAL-100 NTSC-100
RESERVED			1						Set to One
CKE ⁴		0							Color Kill Disabled
		1							Color Kill Enabled
RESERVED	1								Set to One

NOTES

¹Peak White Update. Determines the gain based on measurements taken from the active video; this bit determines the rate of gain change. LAGC[1:0] must be set to the appropriate mode to enable peak white or average video in the first case.

²Average Brightness Active Lines. Allows the selection between two ranges of active video to determine the average brightness.

³Max IRE. Sets the max I/p IRE level depending on the video standard.

⁴Color Kill Enable. Allows the optional color kill function to be switched on or off.

Table XLV. HSync Position Control 1 Register (Subaddress 34)

Bit Description	Bit 7	Bit 6	Bit 5	Bit 4	Bit 3	Bit 2	Bit 1	Bit 0	Register Setting
RESERVED					1	1	1	1	Set to One
HSE[9:8] ¹			0	0					HSync ends after HSE[9:0] pixel after falling edge of HSync.
HSB[9:8] ²	0	0							HSync starts after HSB[9:0] pixel after the falling edge of HSync.

NOTES

¹HSync End. Allows the positioning of the HSync output within the video line.

²HSync Begin. Allows the positioning of HSync output within the video line.

Table XLVI. HSync Position Control 2 Register (Subaddress 35)

Bit Description	Bit 7	Bit 6	Bit 5	Bit 4	Bit 3	Bit 2	Bit 1	Bit 0	Register Setting
HSB[7:0] ¹	0	0	0	0	0	0	0	1	

¹Using HSB[9:0] and HSE[9:0] the user can program the position and length of HSync output signal.

Table XLVII. HSync Position Control 3 Register (Subaddress 36)

Bit Description	Bit 7	Bit 6	Bit 5	Bit 4	Bit 3	Bit 2	Bit 1	Bit 0	Register Setting
HSE[7:0] ¹	0	0	0	0	0	0	0	0	

¹Using HSB[9:0] and HSE[9:0] the user can program the position and length of HSync output signal.



Table XLVIII. Polarity Register (Subaddress 37)

Bit Description	Bit 7	Bit 6	Bit 5	Bit 4	Bit 3	Bit 2	Bit 1	Bit 0	Register Setting
PCLK ¹								0	Active High
								1	Active Low
PFF ²							0		Active High
							1		Active Low
PDV ³						0			Active High
						1			Active Low
PF ⁴					0				Active High
					1				Active Low
PLLCR ⁵				0					Active High
				1					Active Low
PVS ⁶			0						Active High
			1						Active Low
PHVR ⁷		0							Active High
		1							Active Low
PHS ⁸	0								Active High
	1								Active Low

NOTES

¹Sets the polarity of LLC, LLC2, and QClk.

²Sets the polarity of HFF, AEF, and AFF.

³Sets the polarity for Data Field.

⁴Sets the field sync polarity.

⁵Sets the LLCREF polarity.

⁶Sets the VSync polarity.

⁷Sets the HREF and VREF sync polarities.

⁸Sets HSync polarity.

EEPW 電子產品世界
.com.cn

ADV7185

Table XLIX. Resample Control Register (Subaddress 44)

Bit Description	Bit 7	Bit 6	Bit 5	Bit 4	Bit 3	Bit 2	Bit 1	Bit 0	Register Setting
RESERVED			0	0	0	0	0	1	Set to Default
FSC_INV*		X							NB No Default Value
		0							Compatible with ADV7190, ADV7191, and ADV7194
		1							Compatible with ADV717x
RESERVED	0								Set to Zero

*Color Subcarrier RTCO Inversion. Allows the inversion of the GL bit.

Table L. Reserved (Subaddress 45)

Bit Description	Bit 7	Bit 6	Bit 5	Bit 4	Bit 3	Bit 2	Bit 1	Bit 0	Register Setting
Reserved	0	0	1	X	X	0	1	1	Default Values
Functions	1	0	1	1	1	0	1	1	Set to These Values

Table LI. Reserved (Subaddress F1)

Bit Description	Bit 7	Bit 6	Bit 5	Bit 4	Bit 3	Bit 2	Bit 1	Bit 0	Register Setting
Reserved	1	1	1	1	0	1	1	X	Default Values
Functions	1	1	1	0	1	1	1	1	Set to These Values

Table LII. Reserved (Subaddress H2)

Bit Description	Bit 7	Bit 6	Bit 5	Bit 4	Bit 3	Bit 2	Bit 1	Bit 0	Register Setting
Reserved	1	0	0	1	1	1	0	X	Default Values
Functions	1	0	0	0	0	0	0	0	Set to These Values

Table LIII. Power-On Reset Values for MPU Registers

Register	Addr (Hex)	Default (Hex)	Register	Addr (Hex)	Default (Hex)
BASIC BLOCK			ADVANCED BLOCK		
Input Control	00	00	Reserved	12	XX
Video Selection	01	80	Analog Control (Internal)	13	45
Video Enhancement Control	02	04	Analog Clamp Control	14	18
Output Control	03	0C	Digital Clamp Control 1	15	6X
Extended Output Control	04	0C	Digital Clamp Control 2	16	XX
General-Purpose Output	05	40	Shaping Filter Control	17	01
Reserved	06	XX	Reserved	18	XX
FIFO Control	07	04	Comb Filter Control	19	10
Contrast Control	08	80	Reserved	1A	XX
Saturation Control	09	80	Reserved	1B	XX
Brightness Control	0A	0	Reserved	1C	XX
Hue Control	0B	0	Reserved	1D	XX
Default Value Y	0C	10	Reserved	1E	XX
Default Value C	0D	88	Reserved	1F	XX
Temporal Decimation	0E	00	Reserved	20	XX
Power Management	0F	00	Reserved	21	XX
Status Register	10		Reserved	22	XX
Info Register	11		Color Subcarrier Control 1	23	EX
			Color Subcarrier Control 2	24	XX
			Color Subcarrier Control 3	25	XX
			Color Subcarrier Control 4	26	XX
			Pixel Delay Control	27	58
			Manual Clock Control 1	28	XX
			Manual Clock Control 2	29	XX
			Manual Clock Control 3	2A	XX
			Auto Clock Control .	2B	A0
			AGC Mode Control	2C	CE
			Chroma Gain Control 1	2D	FX
			Chroma Gain Control 2	2E	XX
			Luma Gain Control 1	2F	FX
			Luma Gain Control 2	30	XX
			Manual Gain Shadow Control 1	31	7X
			Manual Gain Shadow Control 2	32	XX
			Miscellaneous Gain Control	33	E3
			Hsync Position Control 1	34	0F
			Hsync Position Control 2	35	01
			Hsync Position Control 3	36	00
			Polarity Control	37	00
			Reserved	44	X1
			Reserved	45	XX
			Reserved	F1	FX
			Reserved	F2	9X

ADV7185

Appendix

BOARD DESIGN AND LAYOUT CONSIDERATIONS

The ADV7185 is a highly integrated circuit containing both precision analog and high speed digital circuitry. It has been designed to minimize interference effects on the integrity of the analog circuitry by the high speed digital circuitry. It is imperative that these same design and layout techniques be applied to the system level design such that high speed and accurate performance are achieved. Figure 30 shows the recommended analog circuit layout.

The layout should be optimized for lowest noise on the ADV7185 power and ground lines by shielding the digital inputs and providing good decoupling. The lead length between groups of VDD and GND pins should be minimized to reduce inductive ringing.

Ground Planes

The ground plane should be split into two, one analog and one digital. They should be joined directly under the ADV7185. The analog ground return path should be through the digital (the digital ground is connected to the analog ground and also the system ground, whereas the analog ground is only connected to the digital ground; this will ensure only analog current will flow in the analog ground).

Power Planes

The ADV7185 and any associated analog circuitry should have its own power planes, referred to as the analog and digital power planes. These power planes should be connected to the regular PCB power plane (V_{CC}) at a single point through a ferrite bead. This bead should be located within three inches of the ADV7185.

The PCB power plane should provide power to all digital logic on the PC board and the digital power pins on the ADV7185, and the analog power plane should provide power to all analog power pins on the ADV7185.

Plane-to-plane noise coupling can be reduced by ensuring that portions of the regular PCB power and ground planes do not overlay portions of the analog power plane, unless they can be arranged so the plane-to-plane noise is common-mode.

Supply Decoupling

For optimum performance, bypass capacitors should be installed using the shortest leads possible, consistent with reliable operation, to reduce the lead inductance. Best performance is obtained with 0.1 μF ceramic capacitor decoupling. Each group of power pins on the ADV7185 must have at least one 0.1 μF decoupling capacitor to its corresponding ground. These capacitors should be placed as close as possible to the device.

It is important to note that while the ADV7185 contains circuitry to reject power supply noise, this rejection decreases with frequency. If a high-frequency switching power supply is used, the designer should pay close attention to reducing power supply noise and consider using a three-terminal voltage regulator for supplying power to the analog power plane.

Digital Signal Interconnect

The digital inputs and outputs to and from the ADV7185 should be isolated as much as possible from the analog inputs and other analog circuitry. Also, these input signals should not overlay the analog power plane.

Due to the high clock rates involved, long clock lines to and from the ADV7185 should be avoided to reduce noise pickup. Any series termination resistors (typically 33R) for the digital inputs should be connected to the high speed digital outputs.

Analog Signal Interconnect

The ADV7185 should be located as close as possible to the input connectors to minimize noise pickup and reflections due to impedance mismatch.

The video input signals should overlay the ground plane, and not the analog power plane, to maximize the high-frequency power supply rejection.

Digital outputs, especially pixel data Inputs and clocking signals, should never overlay any of the analog signal circuitry and should be kept as far away as possible.

The ADV7185 should have no inputs left floating. Any inputs that are not required should be tied to ground.

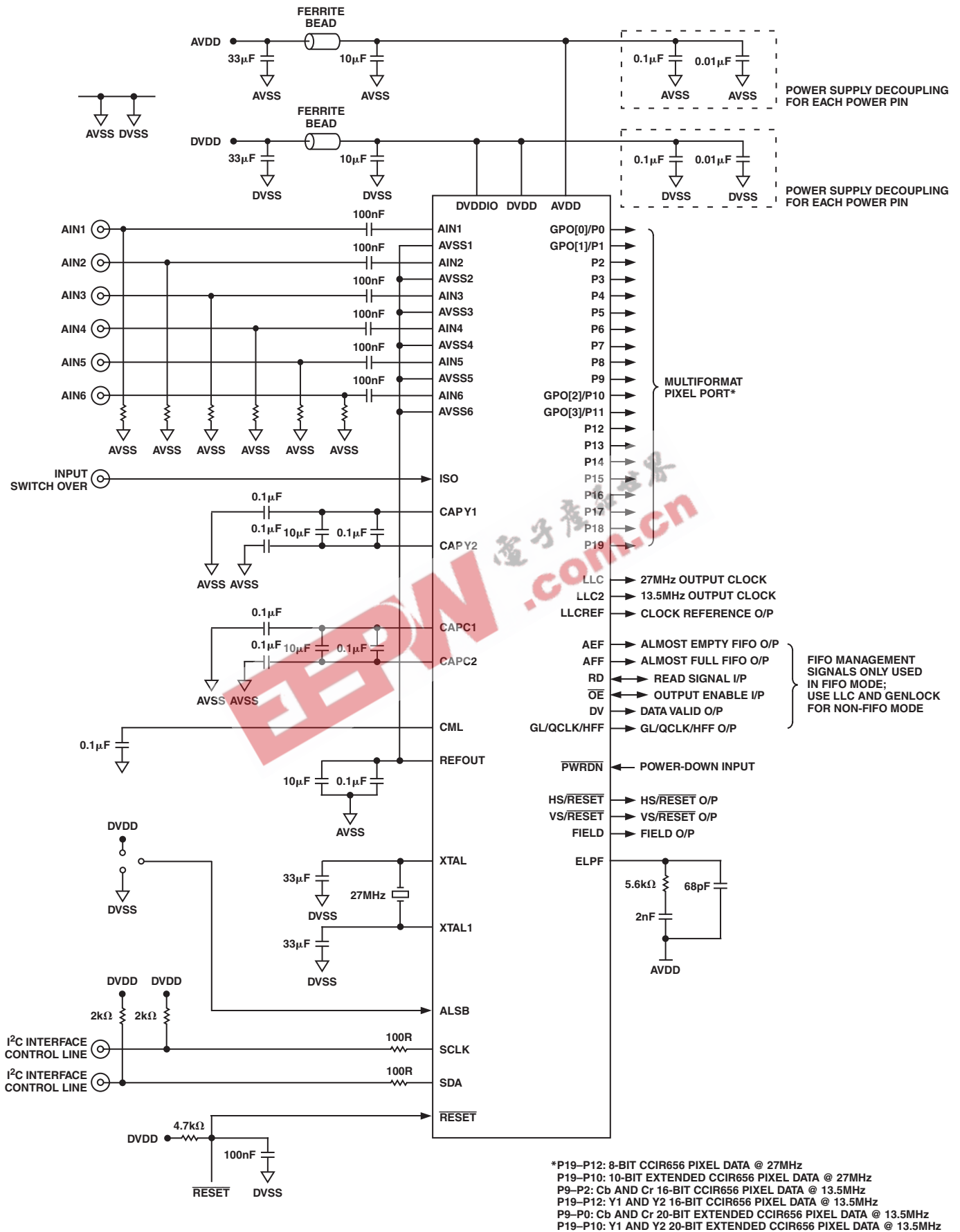
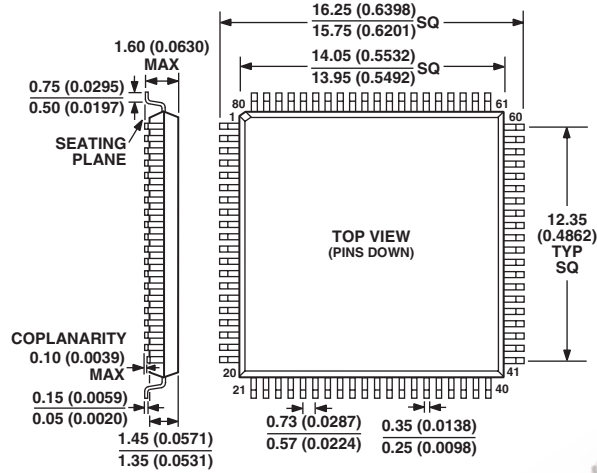

Figure 30. Recommended Analog Circuit Layout

OUTLINE DIMENSIONS

Dimensions shown in millimeters and (inches)

**80-Lead Thin Plastic Quad Flatpack [LQFP]
(ST-80)**



CONTROLLING DIMENSIONS ARE IN MILLIMETERS; INCH DIMENSIONS (IN PARENTHESES) ARE ROUNDED-OFF MILLIMETER EQUIVALENTS FOR REFERENCE ONLY AND ARE NOT APPROPRIATE FOR USE IN DESIGN

