

ADR520/ADR525/ADR530/ADR540/ADR550

FEATURES

- Ultracompact SC70 and SOT-23 packages
- Temperature coefficient: 40 ppm/°C (max)
- 2× the tempco improvement over the LM4040
- Pin compatible with LM4040/LM4050
- Initial accuracy: ±0.2%
- Low output voltage noise: 14 μV p-p @ 2.5 V output
- No external capacitor required
- Operating current range: 50 μA to 10 mA
- Industrial temperature range: -40°C to +85°C

APPLICATIONS

- Portable, battery-powered equipment
- Automotive
- Power supplies
- Data acquisition systems
- Instrumentation and process control
- Energy measurement

Table 1. Selection Guide

Part	Voltage (V)	Initial Accuracy (%)	Temperature Coefficient (ppm/°C)
ADR520A	2.048	±0.4	70
ADR520B	2.048	±0.2	40
ADR525A	2.5	±0.4	70
ADR525B	2.5	±0.2	40
ADR530A	3.0	±0.4	70
ADR530B	3.0	±0.2	40
ADR540A	4.096	±0.4	70
ADR540B	4.096	±0.2	40
ADR550A	5.0	±0.4	70
ADR550B	5.0	±0.2	40

PIN CONFIGURATION

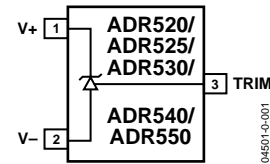

Figure 1. 3-Lead SC70 (KS)
and 3-Lead SOT-23 (RT)

GENERAL DESCRIPTION

Designed for space-critical applications, the ADR520/ADR525/ADR530/ADR540/ADR550 are high precision shunt voltage references, housed in ultrasmall SC70 and SOT-23 packages. These references feature low temperature drift of 40 ppm/°C, an initial accuracy of better than 0.2%, and ultralow output noise of 14 μV p-p.

Available in output voltages of 2.048 V, 2.5 V, 3.0 V, 4.096 V, and 5.0 V, the ADR5xx's advanced design eliminates the need for compensation by an external capacitor, yet the references are stable with any capacitive load. The minimum operating current increases from a mere 50 μA to a maximum of 10 mA. This low operating current and ease of use make these references ideally suited for handheld, battery-powered applications.

A TRIM terminal is available on the ADR5xx to allow adjustment of the output voltage over a ±0.5% range, without affecting the temperature coefficient of the device. This feature provides users with the flexibility to trim out any system errors.

Rev. A

Information furnished by Analog Devices is believed to be accurate and reliable. However, no responsibility is assumed by Analog Devices for its use, nor for any infringements of patents or other rights of third parties that may result from its use. Specifications subject to change without notice. No license is granted by implication or otherwise under any patent or patent rights of Analog Devices. Trademarks and registered trademarks are the property of their respective owners.

TABLE OF CONTENTS

Specifications.....	3	Theory of Operation	11
Absolute Maximum Ratings.....	6	Applications	11
Parameter Definitions	7	Outline Dimensions	13
Typical Performance Characteristics	8	Ordering Guide.....	14

REVISION HISTORY

11/03—Revision 0: Initial Version	
12/03—Data Sheet Changed from REV. 0 to REV. A	
Updated Outline Dimensions	13
Change to Ordering Guide.....	14



SPECIFICATIONS

Table 2. ADR520 Electrical Characteristics @ $I_{IN} = 50 \mu\text{A}$ to 10 mA, $T_A = 25^\circ\text{C}$, unless otherwise noted

Parameter	Symbol	Conditions	Min	Typ	Max	Unit
Output Voltage	V_O					
Grade A			2.040	2.048	2.056	V
Grade B			2.044	2.048	2.052	V
Initial Accuracy	V_{OERR}					
Grade A		$\pm 0.4\%$	-8		+8	mV
Grade B		$\pm 0.2\%$	-4		+4	mV
Temperature Coefficient ¹	TCV_O	$-40^\circ\text{C} < T_A < +85^\circ\text{C}$				
Grade A				25	70	ppm/ $^\circ\text{C}$
Grade B				15	40	ppm/ $^\circ\text{C}$
Output Voltage Change vs. I_{IN}	ΔV_R	$I_{IN} = 0.1 \text{ mA to } 10 \text{ mA}$ $-40^\circ\text{C} < T_A < +85^\circ\text{C}$			1	mV
		$I_{IN} = 1 \text{ mA to } 10 \text{ mA}$ $-40^\circ\text{C} < T_A < +85^\circ\text{C}$			4	mV
Dynamic Output Impedance	$(\Delta V_R / \Delta I_R)$	$I_{IN} = 0.1 \text{ mA to } 10 \text{ mA}$ $-40^\circ\text{C} < T_A < +85^\circ\text{C}$			2	mV
Minimum Operating Current	I_{IN}	$-40^\circ\text{C} < T_A < +85^\circ\text{C}$	50			μA
Voltage Noise	$e_{N \text{ p-p}}$	0.1 Hz to 10 Hz		14		$\mu\text{V p-p}$
Turn-On Settling Time	t_R			2		μs
Output Voltage Hysteresis	ΔV_{O_HYS}	$I_{IN} = 1 \text{ mA}$		40		ppm

¹Guaranteed by design

Table 3. ADR525 Electrical Characteristics @ $I_{IN} = 50 \mu\text{A}$ to 10 mA, $T_A = 25^\circ\text{C}$, unless otherwise noted

Parameter	Symbol	Conditions	Min	Typ	Max	Unit
Output Voltage	V_O					
Grade A			2.490	2.500	2.510	V
Grade B			2.495	2.500	2.505	V
Initial Accuracy	V_{OERR}					
Grade A		$\pm 0.4\%$	-10		+10	mV
Grade B		$\pm 0.2\%$	-5		+5	mV
Temperature Coefficient ¹	TCV_O	$-40^\circ\text{C} < T_A < +85^\circ\text{C}$				
Grade A				25	70	ppm/ $^\circ\text{C}$
Grade B				15	40	ppm/ $^\circ\text{C}$
Output Voltage Change vs. I_{IN}	ΔV_R	$I_{IN} = 0.1 \text{ mA to } 10 \text{ mA}$ $-40^\circ\text{C} < T_A < +85^\circ\text{C}$			1	mV
		$I_{IN} = 1 \text{ mA to } 10 \text{ mA}$ $-40^\circ\text{C} < T_A < +85^\circ\text{C}$			4	mV
Dynamic Output Impedance	$(\Delta V_R / \Delta I_R)$	$I_{IN} = 0.1 \text{ mA to } 10 \text{ mA}$ $-40^\circ\text{C} < T_A < +85^\circ\text{C}$			2	mV
Minimum Operating Current	I_{IN}	$-40^\circ\text{C} < T_A < +85^\circ\text{C}$	50		0.2	Ω
Voltage Noise	$e_{N \text{ p-p}}$	0.1 Hz to 10 Hz		14		$\mu\text{V p-p}$
Turn-On Settling Time	t_R			2		μs
Output Voltage Hysteresis	ΔV_{O_HYS}	$I_{IN} = 1 \text{ mA}$		40		ppm

¹Guaranteed by design

ADR520/ADR525/ADR530/ADR540/ADR550

Table 4. ADR530 Electrical Characteristics @ $I_{IN} = 50 \mu\text{A}$ to 10 mA, $T_A = 25^\circ\text{C}$, unless otherwise noted

Parameter	Symbol	Conditions	Min	Typ	Max	Unit
Output Voltage	V_O					
Grade A			2.988	3.000	3.012	V
Grade B			2.994	3.000	3.006	V
Initial Accuracy	V_{OERR}					
Grade A		$\pm 0.4\%$	-12		+12	mV
Grade B		$\pm 0.2\%$	-6		+6	mV
Temperature Coefficient ¹	TCV_O	$-40^\circ\text{C} < T_A < +85^\circ\text{C}$				
Grade A				25	70	ppm/ $^\circ\text{C}$
Grade B				15	40	ppm/ $^\circ\text{C}$
Output Voltage Change vs. I_{IN}	ΔV_R	$I_{IN} = 0.1 \text{ mA to } 10 \text{ mA}$ $-40^\circ\text{C} < T_A < +85^\circ\text{C}$			1	mV
		$I_{IN} = 1 \text{ mA to } 10 \text{ mA}$ $-40^\circ\text{C} < T_A < +85^\circ\text{C}$			4	mV
		$I_{IN} = 0.1 \text{ mA to } 10 \text{ mA}$ $-40^\circ\text{C} < T_A < +85^\circ\text{C}$			2	mV
Dynamic Output Impedance	$(\Delta V_R / \Delta I_R)$	$I_{IN} = 0.1 \text{ mA to } 10 \text{ mA}$ $-40^\circ\text{C} < T_A < +85^\circ\text{C}$			0.2	Ω
Minimum Operating Current	I_{IN}	$-40^\circ\text{C} < T_A < +85^\circ\text{C}$	50			μA
Voltage Noise	$e_{N \text{ p-p}}$	0.1 Hz to 10 Hz		16		$\mu\text{V p-p}$
Turn-On Settling Time	t_R			2		μs
Output Voltage Hysteresis	ΔV_{O_HYS}	$I_{IN} = 1 \text{ mA}$		40		ppm

¹Guaranteed by design

Table 5. ADR540 Electrical Characteristics @ $I_{IN} = 50 \mu\text{A}$ to 10 mA, $T_A = 25^\circ\text{C}$, unless otherwise noted

Parameter	Symbol	Conditions	Min	Typ	Max	Unit
Output Voltage	V_O					
Grade A			4.08	4.096	4.112	V
Grade B			4.088	4.096	4.104	V
Initial Accuracy	V_{OERR}					
Grade A		$\pm 0.4\%$	-16		+16	mV
Grade B		$\pm 0.2\%$	-8		+8	mV
Temperature Coefficient ¹	TCV_O	$-40^\circ\text{C} < T_A < +85^\circ\text{C}$				
Grade A				25	70	ppm/ $^\circ\text{C}$
Grade B				15	40	ppm/ $^\circ\text{C}$
Output Voltage Change vs. I_{IN}	ΔV_R	$I_{IN} = 0.1 \text{ mA to } 10 \text{ mA}$ $-40^\circ\text{C} < T_A < +85^\circ\text{C}$			1	mV
		$I_{IN} = 1 \text{ mA to } 10 \text{ mA}$ $-40^\circ\text{C} < T_A < +85^\circ\text{C}$			5	mV
		$I_{IN} = 0.1 \text{ mA to } 10 \text{ mA}$ $-40^\circ\text{C} < T_A < +85^\circ\text{C}$			2	mV
Dynamic Output Impedance	$(\Delta V_R / \Delta I_R)$	$I_{IN} = 0.1 \text{ mA to } 10 \text{ mA}$ $-40^\circ\text{C} < T_A < +85^\circ\text{C}$			0.2	Ω
Minimum Operating Current	I_{IN}	$-40^\circ\text{C} < T_A < +85^\circ\text{C}$	50			μA
Voltage Noise	$e_{N \text{ p-p}}$	0.1 Hz to 10 Hz		18		$\mu\text{V p-p}$
Turn-On Settling Time	t_R			2		μs
Output Voltage Hysteresis	ΔV_{O_HYS}	$I_{IN} = 1 \text{ mA}$		40		ppm

¹Guaranteed by design

ADR520/ADR525/ADR530/ADR540/ADR550

Table 6. ADR550 Electrical Characteristics @ $I_{IN} = 50 \mu\text{A}$ to 10 mA, $T_A = 25^\circ\text{C}$, unless otherwise noted

Parameter	Symbol	Conditions	Min	Typ	Max	Unit
Output Voltage	V_O					
Grade A			4.980	5.000	5.020	V
Grade B			4.090	5.000	5.010	V
Initial Accuracy	V_{OERR}					
Grade A		$\pm 0.4\%$	-20		+20	mV
Grade B		$\pm 0.2\%$	-10		+10	mV
Temperature Coefficient ¹	TCV_O	$-40^\circ\text{C} < T_A < +85^\circ\text{C}$				
Grade A				25	70	ppm/ $^\circ\text{C}$
Grade B				15	40	ppm/ $^\circ\text{C}$
Output Voltage Change vs. I_{IN}	ΔV_R	$I_{IN} = 0.1 \text{ mA to } 10 \text{ mA}$ $-40^\circ\text{C} < T_A < +85^\circ\text{C}$			1	mV
		$I_{IN} = 1 \text{ mA to } 10 \text{ mA}$ $-40^\circ\text{C} < T_A < +85^\circ\text{C}$			5	mV
		$I_{IN} = 0.1 \text{ mA to } 10 \text{ mA}$ $-40^\circ\text{C} < T_A < +85^\circ\text{C}$			2	mV
Dynamic Output Impedance	$(\Delta V_R / \Delta I_R)$	$I_{IN} = 0.1 \text{ mA to } 10 \text{ mA}$ $-40^\circ\text{C} < T_A < +85^\circ\text{C}$			0.2	Ω
Minimum Operating Current	I_{IN}	$-40^\circ\text{C} < T_A < +85^\circ\text{C}$	50			μA
Voltage Noise	$e_{N \text{ p-p}}$	0.1 Hz to 10 Hz		18		$\mu\text{V p-p}$
Turn-On Settling Time	t_R			2		μs
Output Voltage Hysteresis	ΔV_{O_HYS}	$I_{IN} = 1 \text{ mA}$		40		ppm

¹Guaranteed by design

ADR520/ADR525/ADR530/ADR540/ADR550

ABSOLUTE MAXIMUM RATINGS

Ratings apply at 25°C, unless otherwise noted.

Table 7.

Parameter	Rating
Reverse Current	25 mA
Forward Current	20 mA
Storage Temperature Range	-65°C to +150°C
Industrial Temperature Range	-40°C to +85°C
Junction Temperature Range	-65°C to +150°C
Lead Temperature Range (Soldering, 60 sec)	300°C

Stresses above those listed under Absolute Maximum Ratings may cause permanent damage to the device. This is a stress rating only; functional operation of the device at these or any other conditions above those listed in the operational sections of this specification is not implied. Exposure to absolute maximum rating conditions for extended periods may affect device reliability.

Package Type	θ_{JA}^1	θ_{JC}	Unit
3-Lead SC70 (KS)	376		°C/W
3-Lead SOT-23 (RT)	230	146	°C/W

¹ θ_{JA} is specified for worst-case conditions, i.e., θ_{JA} is specified for devices soldered on circuit boards for surface-mount packages. Contact factory for latest information on release dates.

ESD CAUTION

ESD (electrostatic discharge) sensitive device. Electrostatic charges as high as 4000 V readily accumulate on the human body and test equipment and can discharge without detection. Although this product features proprietary ESD protection circuitry, permanent damage may occur on devices subjected to high energy electrostatic discharges. Therefore, proper ESD precautions are recommended to avoid performance degradation or loss of functionality.



PARAMETER DEFINITIONS

TEMPERATURE COEFFICIENT

Temperature coefficient is defined as the change in output voltage with respect to operating temperature changes, and is normalized by an output voltage of 25°C. This parameter is expressed in ppm/°C, and is determined by the following equation:

$$TCV_o \left[\frac{ppm}{^\circ C} \right] = \frac{V_o(T_2) - V_o(T_1)}{V_o(25^\circ C) \times (T_2 - T_1)} \times 10^6 \quad (1)$$

where:

$V_o(25^\circ C) = V_o$ at 25°C.

$V_o(T_1) = V_o$ at Temperature 1.

$V_o(T_2) = V_o$ at Temperature 2.

THERMAL HYSTERESIS

Thermal hysteresis is defined as the change in output voltage after the device is cycled through temperatures ranging from +25°C to -40°C, then to +85°C, and back to +25°C. The following equation expresses a typical value from a sample of parts put through such a cycle:

$$V_{O_HYS} = V_o(25^\circ C) - V_{O_TC}$$

$$V_{O_HYS} [ppm] = \frac{V_o(25^\circ C) - V_{O_TC}}{V_o(25^\circ C)} \times 10^6 \quad (2)$$

where:

$V_o(25^\circ C) = V_o$ at 25°C.

$V_{O_TC} = V_o$ at 25°C after a temperature cycle from +25°C to -40°C, then to +85°C, and back to +25°C.

EEPW 电子产品世界
.com.cn

TYPICAL PERFORMANCE CHARACTERISTICS

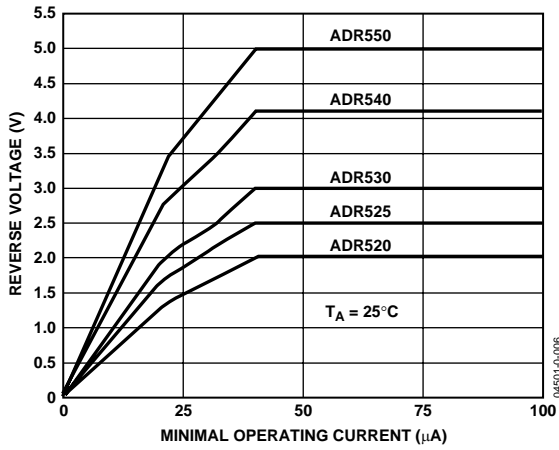

Figure 2. Reverse Characteristics and Minimum Operating Current

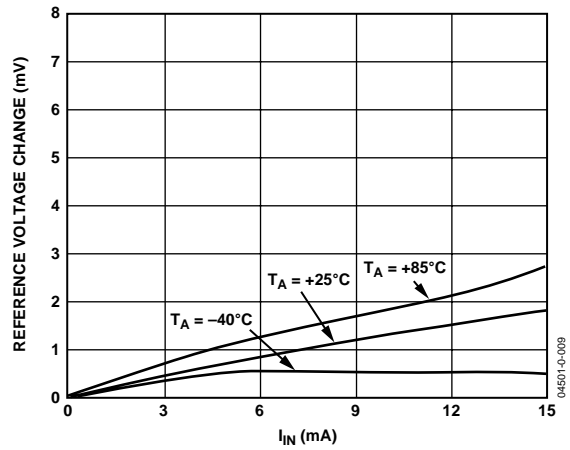

Figure 5. ADR550 Reverse Voltage vs. Operating Current

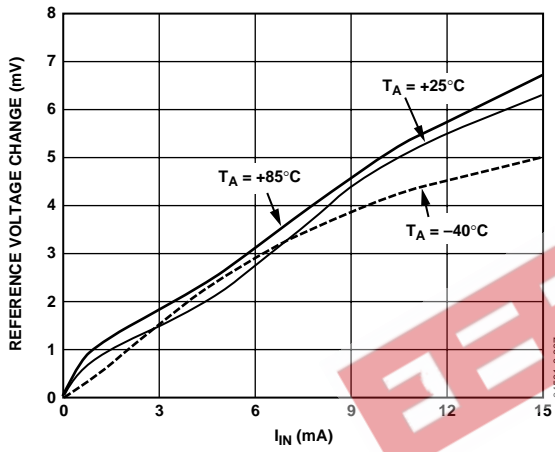

Figure 3. ADR520 Reverse Voltage vs. Operating Current

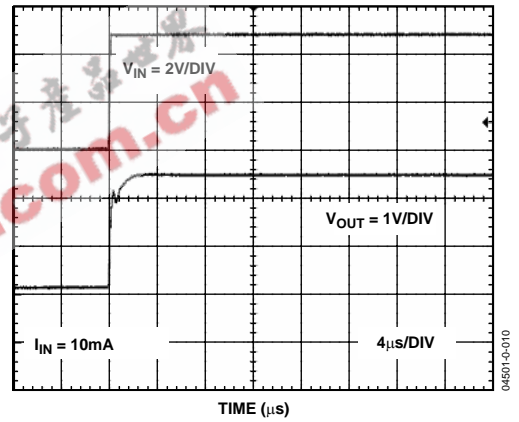

Figure 6. ADR525 Turn-On Response

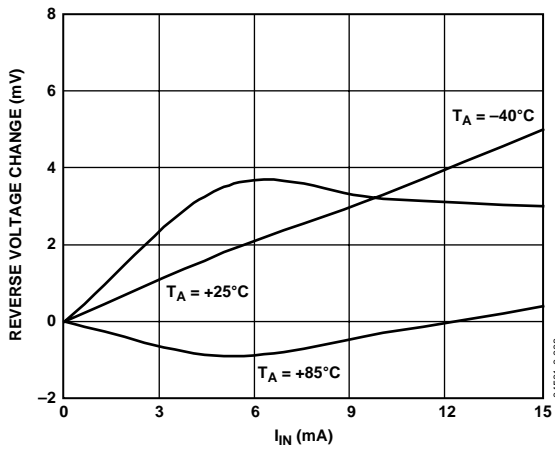

Figure 4. ADR525 Reverse Voltage vs. Operating Current

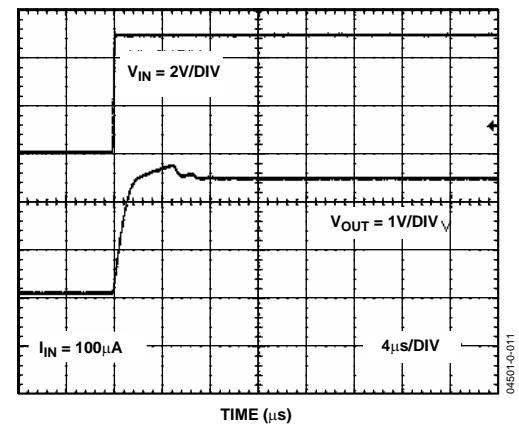

Figure 7. ADR525 Turn-On Response

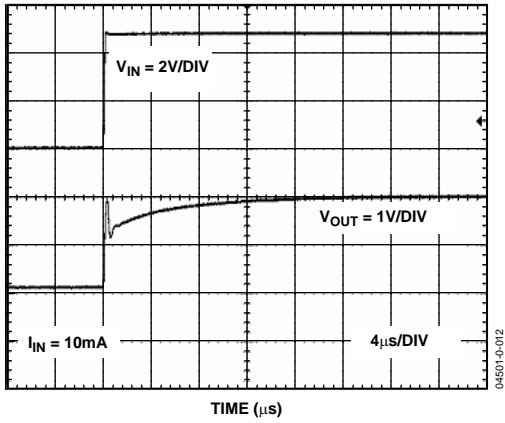

Figure 8. ADR520 Turn-On Response

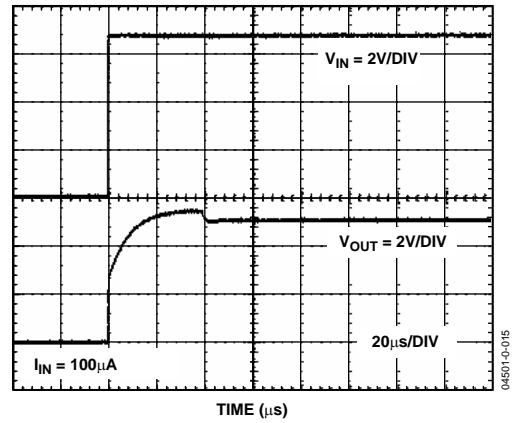

Figure 11. ADR550 Turn-On Response

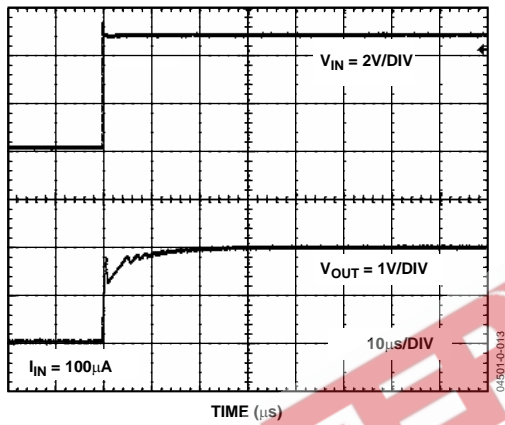

Figure 9. ADR520 Turn-On Response

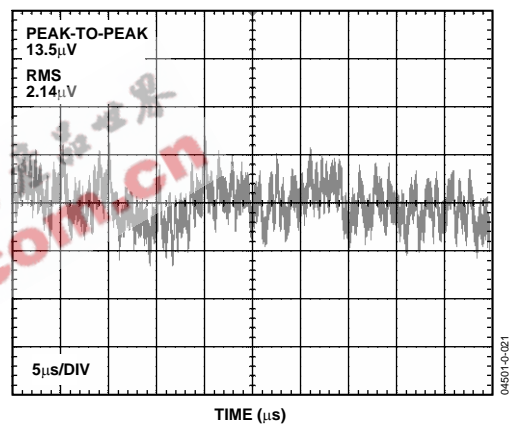

Figure 12. ADR520 Noise Voltage 0.1 Hz to 10 Hz

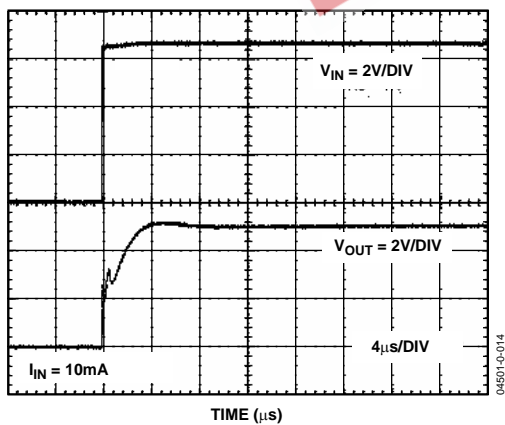

Figure 10. ADR550 Turn-On Response

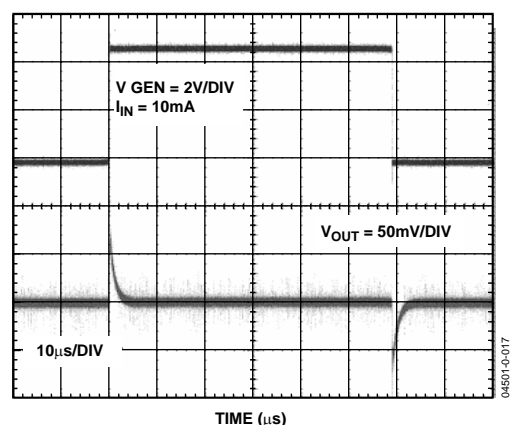

Figure 13. ADR525 Load Transient Response

ADR520/ADR525/ADR530/ADR540/ADR550

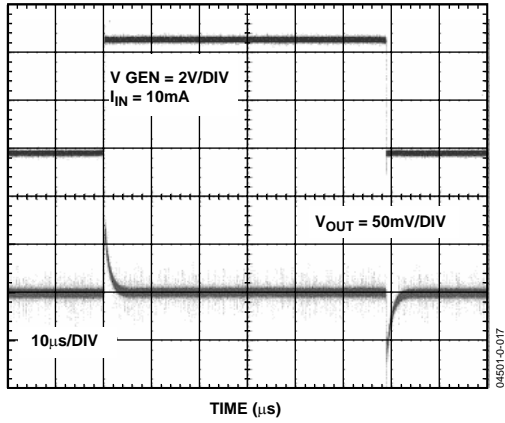

Figure 14. ADR550 Load Transient Response

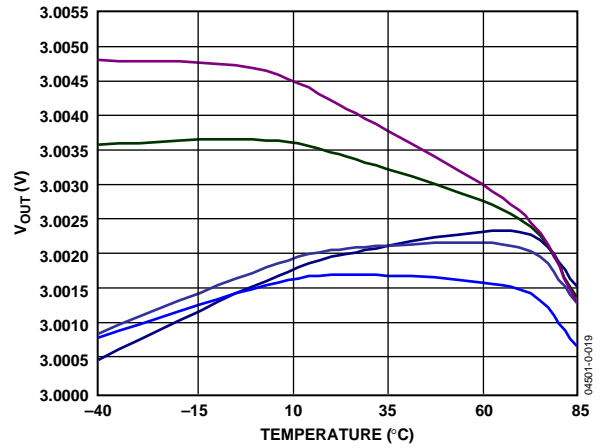

Figure 16. ADR530 V_{OUT} over Temperature

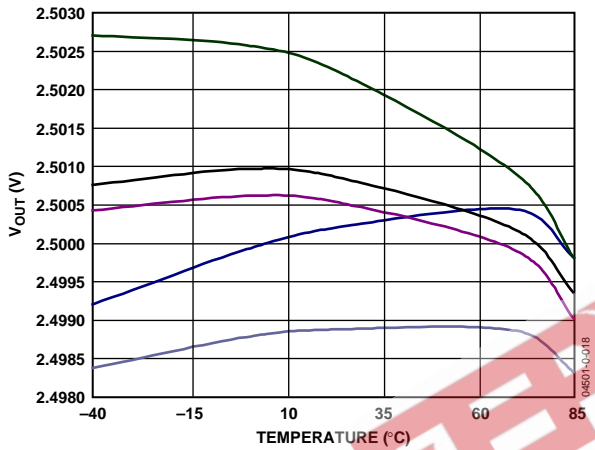

Figure 15. ADR525 V_{OUT} over Temperature

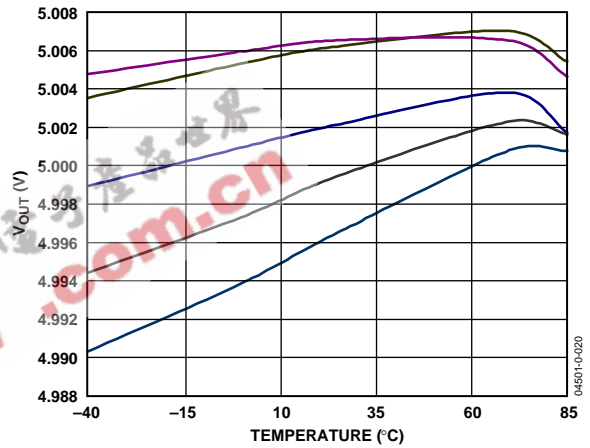

Figure 17. ADR550 V_{OUT} over Temperature

THEORY OF OPERATION

The ADR520/ADR525/ADR530/ADR540/ADR550 use the band gap concept to produce a stable, low temperature coefficient voltage reference suitable for high accuracy data acquisition components and systems. The devices use the physical nature of a silicon transistor base-emitter voltage in the forward-biased operating region. All such transistors have approximately a $-2 \text{ mV}/^\circ\text{C}$ temperature coefficient (TC), making them unsuitable for direct use as a low temperature coefficient reference. Extrapolation of the temperature characteristic of any one of these devices to absolute zero (with the collector current proportional to the absolute temperature), however, reveals that its V_{BE} approaches approximately the silicon band gap voltage. Thus, if a voltage develops with an opposing temperature coefficient to sum the V_{BE} , a zero temperature coefficient reference results. The ADR5xx circuit shown in Figure 18 provides such a compensating voltage (V_1) by driving two transistors at different current densities and amplifying the resultant V_{BE} difference (ΔV_{BE} , which has a positive temperature coefficient). The sum of V_{BE} and V_1 provides a stable voltage reference over temperature.

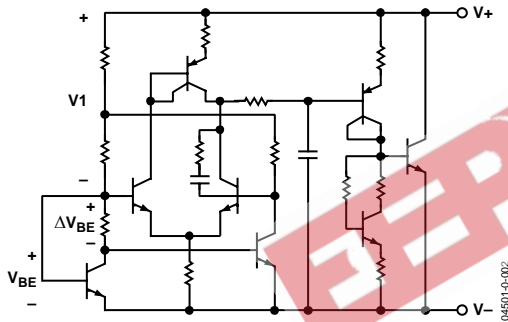

Figure 18. Circuit Schematic

APPLICATIONS

The ADR520/ADR525/ADR530/ADR540/ADR550 are a series of precision shunt voltage references. They are designed to operate without an external capacitor between the positive and negative terminals. If a bypass capacitor is used to filter the supply, the reference remains stable.

All shunt voltage references require an external bias resistor (R_{BIAS}) between the supply voltage and the reference (see Figure 19). The R_{BIAS} sets the current that flows through the load (I_L) and the reference (I_{IN}). Because the load and the supply voltage can vary, the R_{BIAS} needs to be chosen based on the following considerations:

- The R_{BIAS} must be small enough to supply the minimum I_{IN} current to the ADR5xx, even when the supply voltage is at its minimum value and the load current is at its maximum value.

- The R_{BIAS} must be large enough so that I_{IN} does not exceed 10 mA when the supply voltage is at its maximum value and the load current is at its minimum value.

Given these conditions, the R_{BIAS} is determined by the supply voltage (V_{CC}), the ADR5xx load and operating current (I_L and I_Q), and the ADR5xx output voltage (V_{OUT}).

$$R_{BIAS} = \frac{V_{CC} - V_{OUT}}{I_L - I_{IN}} \quad (3)$$

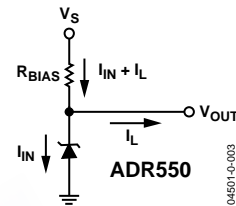

Figure 19. Shunt Reference

Precision Negative Voltage Reference

The ADR5xx is suitable for applications where a precise negative voltage is desired. Figure 20 shows the ADR5xx configured to provide a negative output.

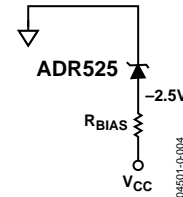

Figure 20. Negative Precision Reference Configuration

Output Voltage Trim

The ADR5xx TRIM terminal can be used to adjust the output voltage over a range of $\pm 0.5\%$. This allows systems designers to trim system errors by setting the reference to a voltage other than the preset output voltage. An external mechanical or electrical potentiometer can be used for this adjustment. Figure 21 illustrates how the output voltage can be trimmed by using the AD5273, an Analog Devices 10 k Ω potentiometer.

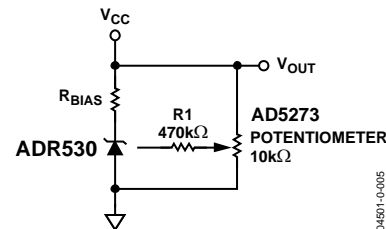

Figure 21. Output Voltage Trim

ADR520/ADR525/ADR530/ADR540/ADR550

Stacking ADR5xx for User-Definable Outputs

Multiple ADR5xx parts can be stacked together to allow the user to obtain a desired higher voltage. Figure 22a shows three ADR550s configured to give 15 V. The bias resistor, R_{BIAS} , is chosen using Equation 3, noting that the same bias current will flow through all the shunt references in series. Figure 22b shows three ADR550s stacked together to give -15 V. R_{BIAS} is calculated in the same manner as before. Parts of different voltages can also be added together, i.e., an ADR525 and an ADR550 can be added together to give an output of $+7.5$ V or -7.5 V, as desired. Note, however, that the initial accuracy error is now the sum of the errors of all the stacked parts, as are the tempco and output voltage change versus input current.

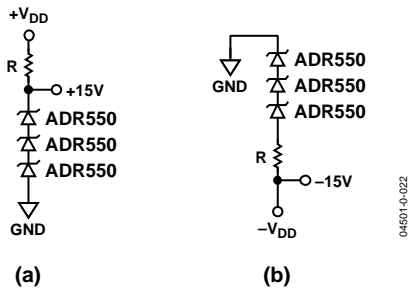

Figure 22. 15 V Output with Stacked ADR550s

Adjustable Precision Voltage Source

The ADR5xx, combined with a precision low input bias op amp, such as the AD8610, can be used to output a precise adjustable voltage. Figure 23 illustrates the implementation of this application using the ADR5xx. The output of the op amp, V_{OUT} , is determined by the gain of the circuit, which is completely dependant on the resistors, $R1$ and $R2$.

$$V_{OUT} = (1 + R2/R1)V_{REF}$$

An additional capacitor, $C1$, in parallel with $R2$, can be added to filter out high frequency noise. The value of $C1$ is dependent on the value of $R2$.

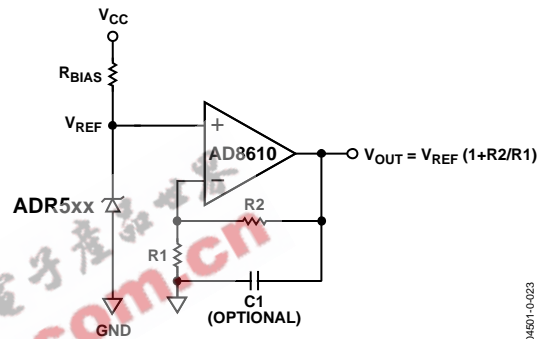

Figure 23. Adjustable Voltage Source

OUTLINE DIMENSIONS

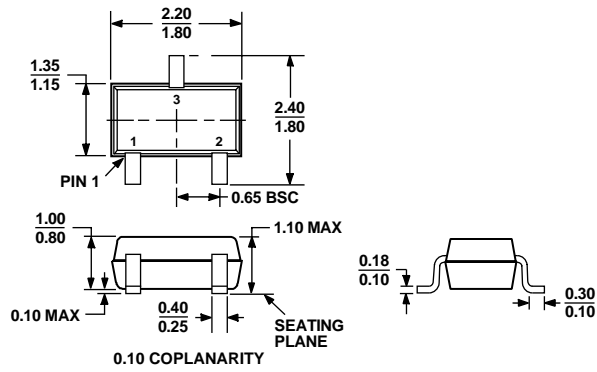

Figure 24. Surface-Mount Package [SC70]

(KS-3)

Dimensions shown in millimeters

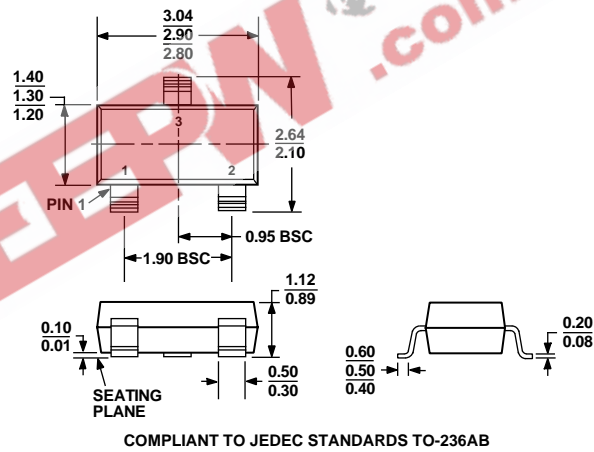

Figure 25. Surface-Mount Package [SOT-23]

(RT-3)

Dimensions shown in millimeters

ADR520/ADR525/ADR530/ADR540/ADR550

ORDERING GUIDE

Model	Output Voltage (V)	Initial Accuracy (mV)	Tempco Industrial (ppm/°C)	Package Description	Package Option	Branding	Number of Parts per Reel	Temperature Range (°C)
ADR520ART-REEL7	2.048	8	70	SOT-23	RT	RQA	3,000	-40 to +85
ADR520ART-R2	2.048	8	70	SOT-23	RT	RQA	250	-40 to +85
ADR520BRT-REEL7	2.048	4	40	SOT-23	RT	RQB	3,000	-40 to +85
ADR520BRT-R2	2.048	4	40	SOT-23	RT	RQB	250	-40 to +85
ADR520BKS-REEL7	2.048	4	40	SC70	KS	RQB	3,000	-40 to +85
ADR520BKS-R2	2.048	4	40	SC70	KS	RQB	250	-40 to +85
ADR525ART-REEL7	2.500	10	70	SOT-23	RT	RRA	3,000	-40 to +85
ADR525ART-R2	2.500	10	70	SOT-23	RT	RRA	250	-40 to +85
ADR525BRT-REEL7	2.500	5	40	SOT-23	RT	RRB	3,000	-40 to +85
ADR525BRT-R2	2.500	5	40	SOT-23	RT	RRB	250	-40 to +85
ADR525BKS-REEL7	2.500	5	40	SC70	KS	RRB	3,000	-40 to +85
ADR525BKS-R2	2.500	5	40	SC70	KS	RRB	250	-40 to +85
ADR530ART-REEL7	3.0	12	70	SOT-23	RT	RSA	3,000	-40 to +85
ADR530ART-R2	3.0	12	70	SOT-23	RT	RSA	250	-40 to +85
ADR530BRT-REEL7	3.0	6	40	SOT-23	RT	RSB	3,000	-40 to +85
ADR530BRT-R2	3.0	6	40	SOT-23	RT	RSB	250	-40 to +85
ADR530BKS-REEL7	3.0	6	40	SC70	KS	RSB	3,000	-40 to +85
ADR530BKS-R2	3.0	6	40	SC70	KS	RSB	250	-40 to +85
ADR540ART-REEL7	4.096	16	70	SOT-23	RT	RTA	3,000	-40 to +85
ADR540ART-R2	4.096	16	70	SOT-23	RT	RTA	250	-40 to +85
ADR540BRT-REEL7	4.096	8	40	SOT-23	RT	RTB	3,000	-40 to +85
ADR540BRT-R2	4.096	8	40	SOT-23	RT	RTB	250	-40 to +85
ADR540BKS-REEL7	4.096	8	40	SC70	KS	RTB	3,000	-40 to +85
ADR540BKS-R2	4.096	8	40	SC70	KS	RTB	250	-40 to +85
ADR550ART-REEL7	5.0	20	70	SOT-23	RT	RVA	3,000	-40 to +85
ADR550ART-R2	5.0	20	70	SOT-23	RT	RVA	250	-40 to +85
ADR550BRT-REEL7	5.0	10	40	SOT-23	RT	RVB	3,000	-40 to +85
ADR550BRT-R2	5.0	10	40	SOT-23	RT	RVB	250	-40 to +85
ADR550BKS-REEL7	5.0	10	40	SC70	KS	RVB	3,000	-40 to +85
ADR550BKS-R2	5.0	10	40	SC70	KS	RVB	250	-40 to +85

NOTES

EEPW 电子产品世界
.com.cn

NOTES

EEPW 电子产品世界
.com.cn