

FEATURES

- All-in-one synchronous buck driver
- Bootstrapped high-side drive
- One PWM signal generates both drives
- Anticross-conduction protection circuitry
- Output disable control turns off both MOSFETs to float output per Intel® VRM 10 specification

APPLICATIONS

- Multiphase desktop CPU supplies
- Single-supply synchronous buck converters

GENERAL DESCRIPTION

The ADP3120 is a dual, high voltage MOSFET driver optimized for driving two N-channel MOSFETs, the two switches in a non-isolated synchronous buck power converter. Each of the drivers is capable of driving a 3000 pF load with a 45 ns propagation delay and a 25 ns transition time. One of the drivers can be bootstrapped and is designed to handle the high voltage slew rate associated with floating high-side gate drivers. The ADP3120 includes overlapping drive protection to prevent shoot-through current in the external MOSFETs.

The \overline{OD} pin shuts off both the high-side and the low-side MOSFETs to prevent rapid output capacitor discharge during system shutdown.

The ADP3120 is specified over the commercial temperature range of 0°C to 85°C and is available in 8-lead SOIC and 8-lead LFCSP packages.

SIMPLIFIED FUNCTIONAL BLOCK DIAGRAM

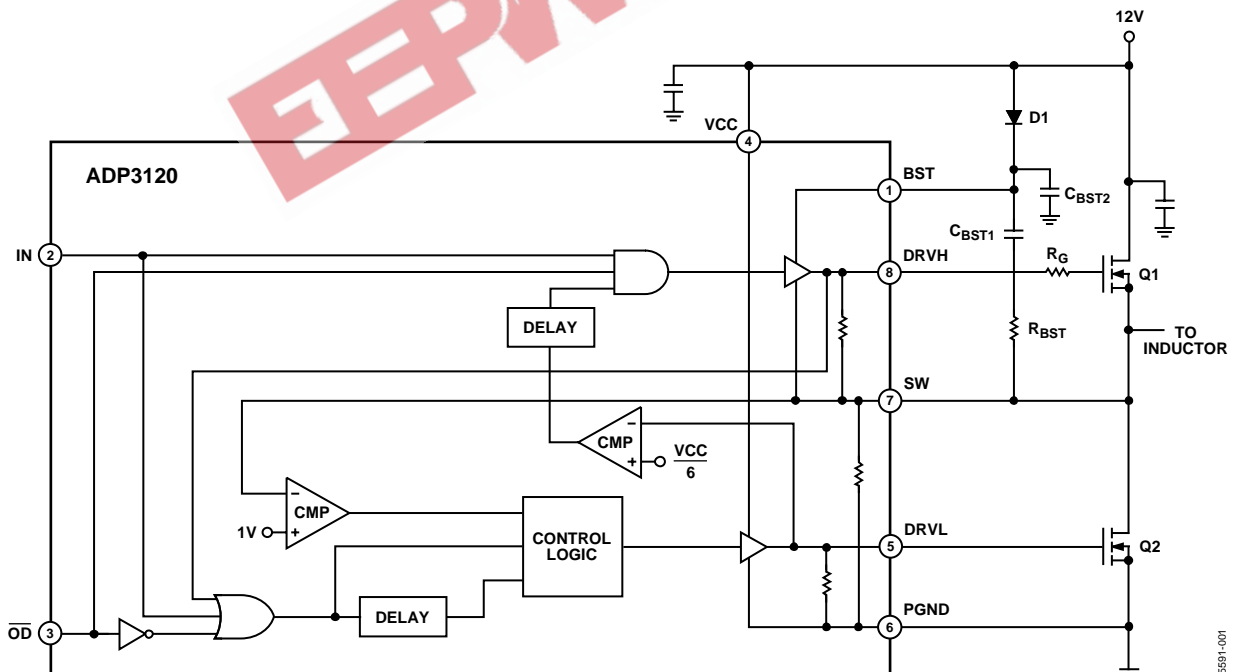

Figure 1.

Rev. 0

Information furnished by Analog Devices is believed to be accurate and reliable. However, no responsibility is assumed by Analog Devices for its use, nor for any infringements of patents or other rights of third parties that may result from its use. Specifications subject to change without notice. No license is granted by implication or otherwise under any patent or patent rights of Analog Devices. Trademarks and registered trademarks are the property of their respective owners.

ADP3120

TABLE OF CONTENTS

Specifications.....	3	Application Information.....	10
Absolute Maximum Ratings.....	4	Supply Capacitor Selection	10
ESD Caution.....	4	Bootstrap Circuit.....	10
Pin Configurations and Function Descriptions	5	MOSFET Selection.....	10
Timing Characteristics.....	6	High-Side (Control) MOSFETs.....	10
Typical Performance Characteristics	7	Low-Side (Synchronous) MOSFETs.....	11
Theory of Operation	9	PC Board Layout Considerations.....	11
Low-Side Driver.....	9	Outline Dimensions.....	13
High-Side Driver	9	Ordering Guide	13
Overlap Protection Circuit.....	9		

REVISION HISTORY

7/05—Revision 0: Initial Version



SPECIFICATIONS¹

VCC = 12 V, BST = 4 V to 26 V, T_A = 0°C to 85°C, unless otherwise noted.

Table 1.

Parameter	Symbol	Conditions	Min	Typ	Max	Unit
PWM INPUT						
Input Voltage High			2.0			V
Input Voltage Low					0.8	V
Input Current			-1		+1	μA
Hysteresis			90	250		mV
OD INPUT						
Input Voltage High			2.0			V
Input Voltage Low					0.8	V
Input Current			-1		+1	μA
Hysteresis			90	250		mV
Propagation Delay Times ²	t _{pdhi} $\overline{\text{OD}}$	See Figure 4		20	35	ns
	t _{pdhl} $\overline{\text{OD}}$	See Figure 4		40	55	ns
HIGH-SIDE DRIVER						
Output Resistance, Sourcing Current		BST – SW = 12 V		2.2	3.5	Ω
Output Resistance, Sinking Current		BST – SW = 12 V		1.0	2.5	Ω
Output Resistance, Unbiased		BST – SW = 0 V		10		kΩ
Transition Times	t _{rDRVH}	BST – SW = 12 V, C _{LOAD} = 3 nF, see Figure 5		25	40	ns
	t _{fDRVH}	BST – SW = 12 V, C _{LOAD} = 3 nF, see Figure 5		20	30	ns
Propagation Delay Times ²	t _{pdhDRVH}	BST – SW = 12 V, C _{LOAD} = 3 nF, 25°C ≤ T _A ≤ 85°C, see Figure 5	32	45	70	ns
	t _{pdlDRVH}	BST – SW = 12 V, C _{LOAD} = 3 nF, see Figure 5		25	35	ns
SW Pull-Down Resistance		SW to PGND		10		kΩ
LOW-SIDE DRIVER						
Output Resistance, Sourcing Current				2.0	3.2	Ω
Output Resistance, Sinking Current				1.0	2.5	Ω
Output Resistance, Unbiased		VCC = PGND		10		kΩ
Transition Times	t _{rDRVL}	C _{LOAD} = 3 nF, Figure 5		20	35	ns
	t _{fDRVL}	C _{LOAD} = 3 nF, Figure 5		16	30	ns
Propagation Delay Times ²	t _{pdhDRVL}	C _{LOAD} = 3 nF, Figure 5		12	35	ns
	t _{pdlDRVL}	C _{LOAD} = 3 nF, Figure 5		30	45	ns
Timeout Delay		SW = 5 V	110	190		ns
		SW = PGND	95	150		ns
SUPPLY						
Supply Voltage Range	VCC		4.15		13.2	V
Supply Current	I _{SYS}	BST = 12 V, IN = 0 V		2	5	mA
UVLO Voltage		VCC rising	1.5		3.0	V
Hysteresis				350		mV

¹ All limits at temperature extremes are guaranteed via correlation using standard statistical quality control (SQC) methods.

² For propagation delays, t_{pdh} refers to the specified signal going high, and t_{pdl} refers to it going low.

ADP3120

ABSOLUTE MAXIMUM RATINGS

Table 2.

Parameter	Rating
VCC	-0.3 V to +15 V
BST	-0.3 V to VCC +15 V
BST to SW	-0.3 V to +15 V
SW	
DC	-5 V to +15 V
<200 ns	-10 V to +25 V
DRVH	
DC	SW - 0.3 V to BST + 0.3 V
<200 ns	SW - 2 V to BST + 0.3 V
DRVL	
DC	-0.3 V to VCC + 0.3 V
<200 ns	-2 V to VCC + 0.3 V
IN, $\overline{\text{OD}}$	-0.3 V to 6.5 V
θ_{JA} , SOIC	
2-Layer Board	123°C/W
4-Layer Board	90°C/W
θ_{JA} , LFCSP ¹	
4-Layer Board	50°C/W
Operating Ambient Temperature Range	0°C to 85°C
Junction Temperature Range	0°C to 150°C
Storage Temperature Range	-65°C to +150°C
Lead Temperature Range	
Soldering (10 sec)	300°C
Vapor Phase (60 sec)	215°C
Infrared (15 sec)	260°C

¹ For LFCSP, θ_{JA} is measured per JEDEC STD with exposed pad soldered to PCB.

Stresses above those listed under Absolute Maximum Ratings may cause permanent damage to the device. This is a stress rating only; functional operation of the device at these or any other conditions above those listed in the operational sections of this specification is not implied. Exposure to absolute maximum rating conditions for extended periods may affect device reliability.

Unless otherwise specified, all voltages are referenced to PGND.

ESD CAUTION

ESD (electrostatic discharge) sensitive device. Electrostatic charges as high as 4000 V readily accumulate on the human body and test equipment and can discharge without detection. Although this product features proprietary ESD protection circuitry, permanent damage may occur on devices subjected to high energy electrostatic discharges. Therefore, proper ESD precautions are recommended to avoid performance degradation or loss of functionality.



PIN CONFIGURATIONS AND FUNCTION DESCRIPTIONS

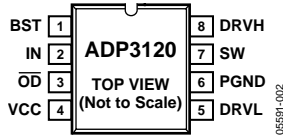

Figure 2. 8-Lead SOIC Pin Configuration

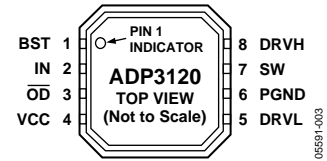

Figure 3. 8-Lead LFCSP Pin Configuration

Table 3. Pin Function Descriptions

Pin No.	Mnemonic	Description
1	BST	Upper MOSFET Floating Bootstrap Supply. A capacitor connected between the BST and SW pins holds this bootstrapped voltage for the high-side MOSFET as it is switched.
2	IN	Logic Level PWM Input. This pin has primary control of the drive outputs. In normal operation, pulling this pin low turns on the low-side driver; pulling it high turns on the high-side driver.
3	$\overline{\text{OD}}$	Output Disable. When low, this pin disables normal operation, forcing DRVH and DRVL low.
4	VCC	Input Supply. This pin should be bypassed to PGND with an $\sim 1 \mu\text{F}$ ceramic capacitor.
5	DRVL	Synchronous Rectifier Drive. Output drive for the lower (synchronous rectifier) MOSFET.
6	PGND	Power Ground. Should be closely connected to the source of the lower MOSFET.
7	SW	This pin is connected to the buck-switching node, close to the upper MOSFET source. It is the floating return for the upper MOSFET drive signal. It is also used to monitor the switched voltage to prevent the lower MOSFET from turning on until the voltage is below $\sim 1 \text{ V}$.
8	DRVH	Buck Drive. Output drive for the upper (buck) MOSFET.

TIMING CHARACTERISTICS

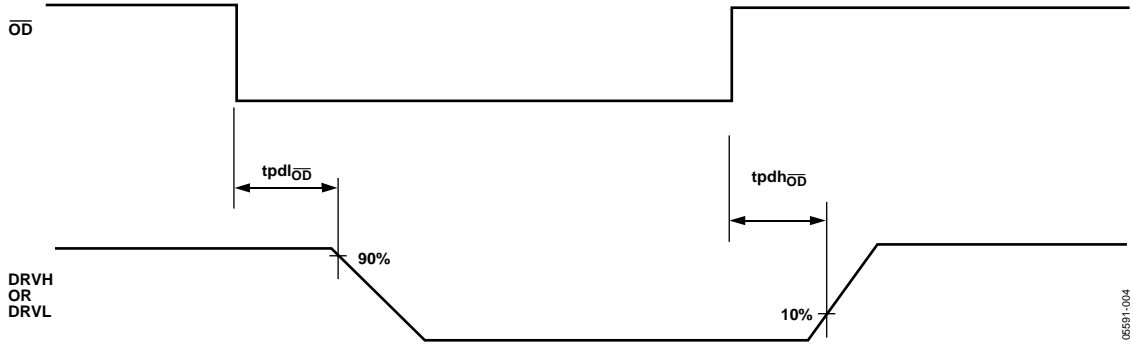

Figure 4. Output Disable Timing Diagram

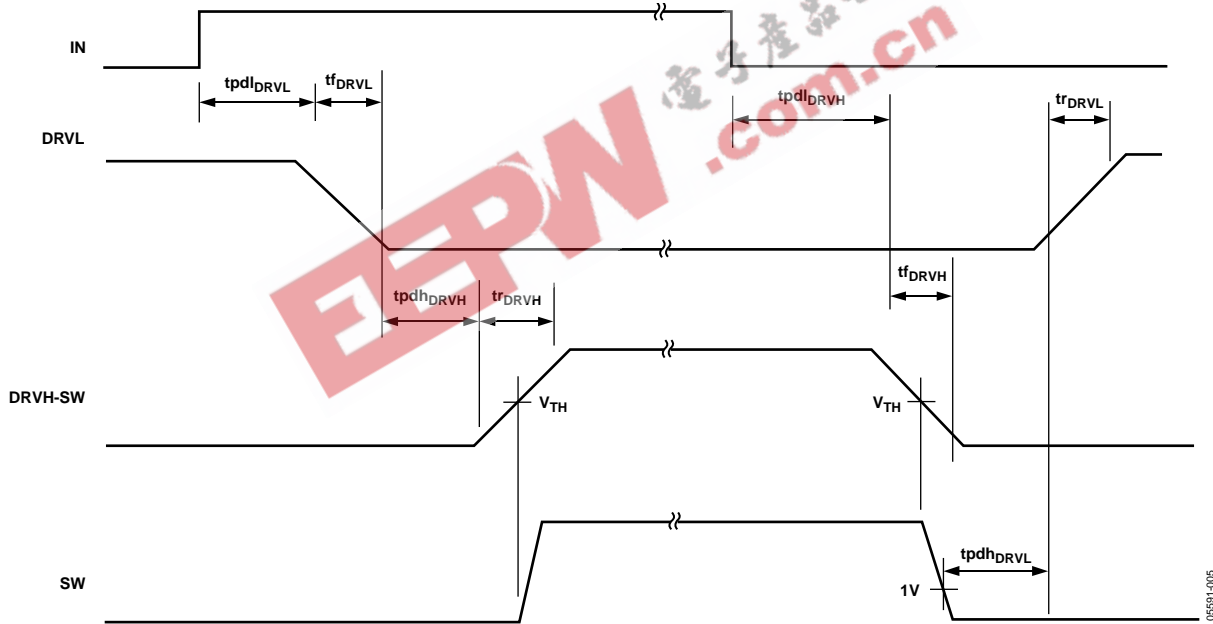

Figure 5. Timing Diagram
 (Timing is referenced to the 90% and 10% points, unless otherwise noted.)

TYPICAL PERFORMANCE CHARACTERISTICS

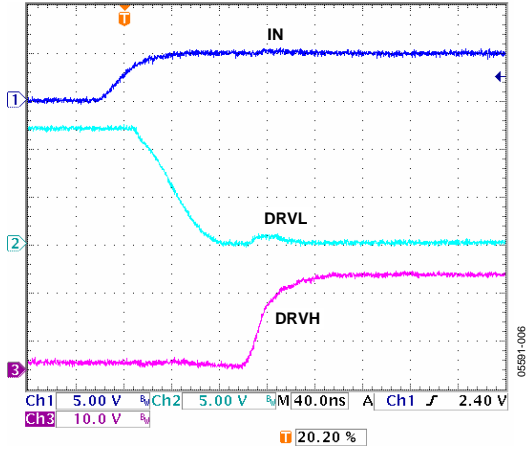

Figure 6. DRVH Rise and DRVL Fall Times
 $C_{LOAD} = 6\text{ nF}$ for DRVL, $C_{LOAD} = 2\text{ nF}$ for DRVH

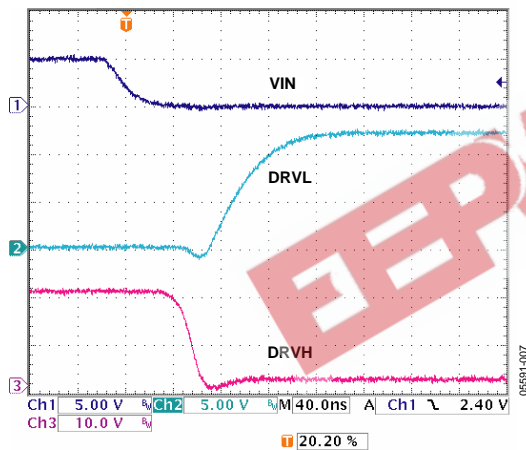

Figure 7. DRVH Fall and DRVL Rise Times
 $C_{LOAD} = 6\text{ nF}$ for DRVL, $C_{LOAD} = 2\text{ nF}$ for DRVH

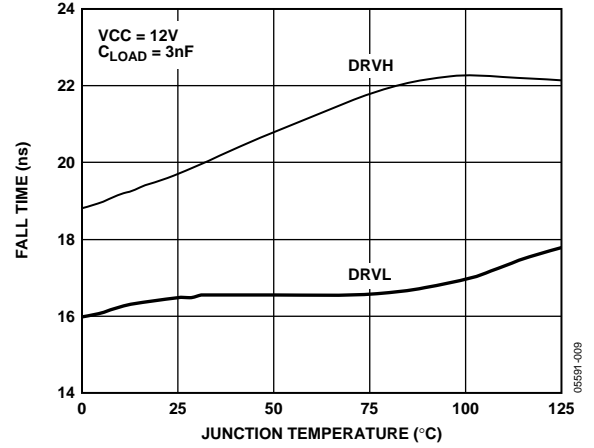

Figure 9. DRVH and DRVL Fall Times vs. Temperature

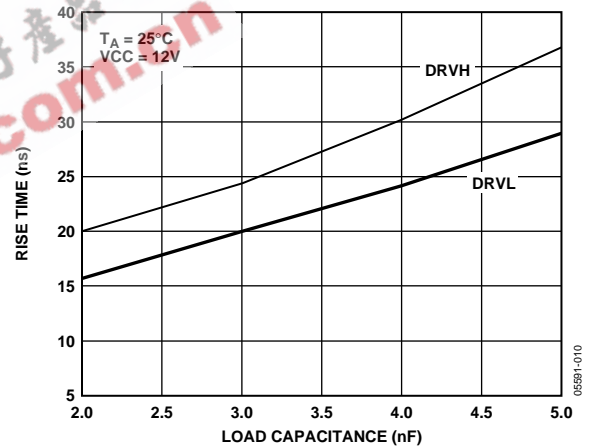

Figure 10. DRVH and DRVL Rise Times vs. Load Capacitance

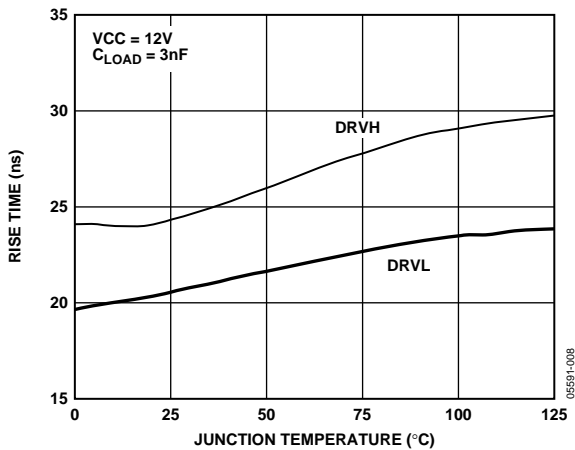

Figure 8. DRVH and DRVL Rise Times vs. Temperature

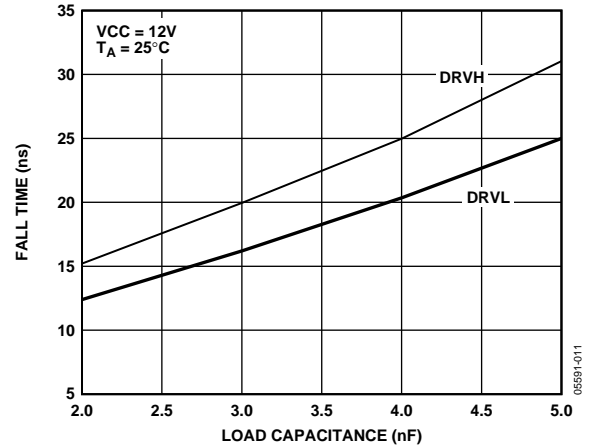

Figure 11. DRVH and DRVL Fall Times vs. Load Capacitance

ADP3120

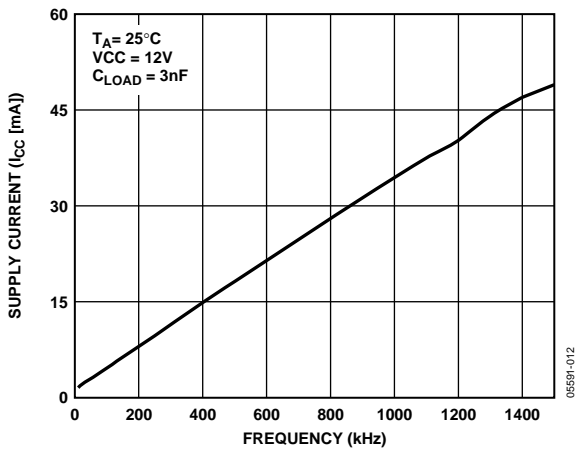

Figure 12. Supply Current vs. Frequency

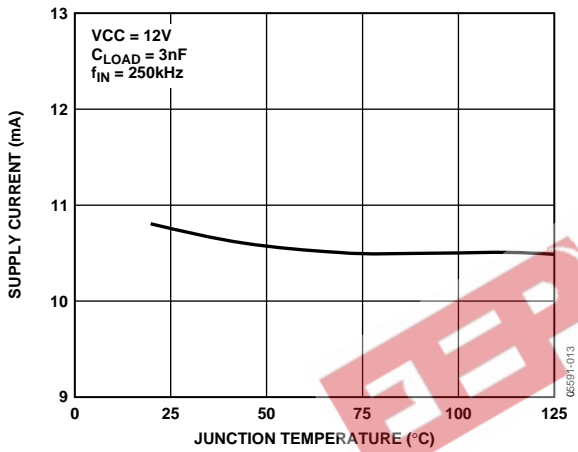

Figure 13. Supply Current vs. Temperature

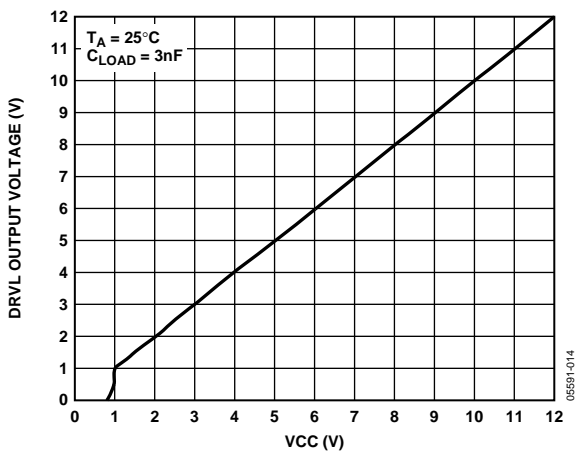

Figure 14. DRVL Output Voltage vs. Supply Voltage

THEORY OF OPERATION

The ADP3120 is optimized for driving two N-channel MOSFETs in a synchronous buck converter topology. A single PWM input signal is all that is required to properly drive the high-side and the low-side MOSFETs. Each driver is capable of driving a 3 nF load at speeds up to 500 kHz.

A more detailed description of the ADP3120 and its features follows. See Figure 1.

LOW-SIDE DRIVER

The low-side driver is designed to drive a ground-referenced N-channel MOSFET. The bias to the low-side driver is internally connected to the VCC supply and PGND.

When the driver is enabled, the driver's output is 180° out of phase with the PWM input. When the ADP3120 is disabled, the low-side gate is held low.

HIGH-SIDE DRIVER

The high-side driver is designed to drive a floating N-channel MOSFET. The bias voltage for the high-side driver is developed by an external bootstrap supply circuit, which is connected between the BST and SW pins.

The bootstrap circuit comprises a diode, D1, and bootstrap capacitor, C_{BST1}. C_{BST2} and R_{BST} are included to reduce the high-side gate drive voltage and to limit the switch node slew rate (called a Boot-Snap circuit—see the Application Information section for more details). When the ADP3120 starts up, the SW pin is at ground, so the bootstrap capacitor charges up to VCC through D1. When the PWM input goes high, the high-side driver begins to turn on the high-side MOSFET, Q1, by pulling charge out of C_{BST1} and C_{BST2}. As Q1 turns on, the SW pin rises up to V_{IN}, forcing the BST pin to V_{IN} + V_{C(BST)}, which is enough gate-to-source voltage to hold Q1 on. To complete the cycle, Q1 is switched off by pulling the gate down to the voltage at the SW pin. When the low-side MOSFET, Q2, turns on, the SW pin is pulled to ground. This allows the bootstrap capacitor to charge up to VCC again.

The output of the high-side driver is in phase with the PWM input. When the driver is disabled, the high-side gate is held low.

OVERLAP PROTECTION CIRCUIT

The overlap protection circuit prevents both of the main power switches, Q1 and Q2, from being on at the same time. This is done to prevent shoot-through currents from flowing through both power switches and the associated losses that can occur during their on/off transitions. The overlap protection circuit accomplishes this by adaptively controlling the delay from the Q1 turn off to the Q2 turn on, and by internally setting the delay from the Q2 turn off to the Q1 turn on.

To prevent the overlap of the gate drives during the Q1 turn off and the Q2 turn on, the overlap circuit monitors the voltage at the SW pin. When the PWM input signal goes low, Q1 begins to turn off (after propagation delay). Before Q2 can turn on, the overlap protection circuit makes sure that SW has first gone high and then waits for the voltage at the SW pin to fall from V_{IN} to 1 V. Once the voltage on the SW pin falls to 1 V, Q2 begins turn on. If the SW pin has not gone high first, the Q2 turn on is delayed by a fixed 150 ns. By waiting for the voltage on the SW pin to reach 1 V or for the fixed delay time, the overlap protection circuit ensures that Q1 is off before Q2 turns on, regardless of variations in temperature, supply voltage, input pulse width, gate charge, and drive current. If SW does not go below 1 V after 190 ns, DRV1 turns on. This can occur if the current flowing in the output inductor is negative and is flowing through the high-side MOSFET body diode.

ADP3120

APPLICATION INFORMATION

SUPPLY CAPACITOR SELECTION

For the supply input (VCC) of the ADP3120, a local bypass capacitor is recommended to reduce the noise and to supply some of the peak currents drawn. Use a 4.7 μF , low ESR capacitor. Multilayer ceramic chip (MLCC) capacitors provide the best combination of low ESR and small size. Keep the ceramic capacitor as close as possible to the ADP3120.

BOOTSTRAP CIRCUIT

The bootstrap circuit uses a charge storage capacitor (C_{BST}) and a diode, as shown in Figure 1. These components can be selected after the high-side MOSFET has been chosen. The bootstrap capacitor must have a voltage rating that can handle twice the maximum supply voltage. A minimum 50 V rating is recommended. The capacitor values are determined using the following equations:

$$C_{BST1} + C_{BST2} = 10 \times \frac{Q_{GATE}}{V_{GATE}} \quad (1)$$

$$\frac{C_{BST1}}{C_{BST1} + C_{BST2}} = \frac{V_{GATE}}{V_{CC} - V_D} \quad (2)$$

where:

Q_{GATE} is the total gate charge of the high-side MOSFET at V_{GATE} .

V_{GATE} is the desired gate drive voltage (usually in the range of 5 V to 10 V, 7 V being typical).

V_D is the voltage drop across D1.

Rearranging Equation 1 and Equation 2 to solve for C_{BST1} yields

$$C_{BST1} = 10 \times \frac{Q_{GATE}}{V_{CC} - V_D}$$

C_{BST2} can then be found by rearranging Equation 1:

$$C_{BST2} = 10 \times \frac{Q_{GATE}}{V_{GATE}} - C_{BST1}$$

For example, an NTD60N02 has a total gate charge of about 12 nC at $V_{GATE} = 7$ V. Using $V_{CC} = 12$ V and $V_D = 1$ V, one finds $C_{BST1} = 12$ nF and $C_{BST2} = 6.8$ nF. Good quality ceramic capacitors should be used.

R_{BST} is used to limit slew rate and to minimize the ringing at the switch node. It also provides peak current limiting through D1. An R_{BST} value of 1.5 Ω to 2.2 Ω is a good choice. The resistor needs to handle at least 250 mW due to the peak currents that flow through it.

A small-signal diode can be used for the bootstrap diode due to the ample gate drive voltage supplied by VCC. The bootstrap diode must have a minimum 15 V rating to withstand the maximum supply voltage. The average forward current can be estimated by

$$I_{F(AVG)} = Q_{GATE} \times f_{MAX} \quad (3)$$

where f_{MAX} is the maximum switching frequency of the controller. The peak surge current rating should be calculated using

$$I_{F(PEAK)} = \frac{V_{CC} - V_D}{R_{BST}} \quad (4)$$

MOSFET SELECTION

When interfacing the ADP3120 to external MOSFETs, the designer should consider ways to make a robust design that minimizes stresses on both the driver and the MOSFETs. These stresses include exceeding the short-time duration voltage ratings on the driver pins as well as the external MOSFET.

It is also highly recommended to use the boot-snap circuit to improve the interaction of the driver with the characteristics of the MOSFETs. If a simple bootstrap arrangement is used, make sure to include a proper snubber network on the SW node.

HIGH-SIDE (CONTROL) MOSFETS

A high-side, high speed MOSFET is usually selected to minimize switching losses (see the ADP3186 or ADP3188 data sheet for Flex-Mode¹ controller details). This typically implies a low gate resistance and low input capacitance/charge device. Yet, a significant source lead inductance can also exist. This depends mainly on the MOSFET package; it is best to contact the MOSFET vendor for this information.

The ADP3120 DRVH output impedance and the input resistance of the MOSFETs determine the rate of charge delivery to the internal capacitance of the gate. This determines the speed at which the MOSFETs turn on and off. However, because of potentially large currents flowing in the MOSFETs at the on and off times (this current is usually larger at turn off due to ramping up of the output current in the output inductor), the source lead inductance generates a significant voltage when the high-side MOSFETs switch off. This creates a significant drain-source voltage spike across the internal die of the MOSFETs and can lead to a catastrophic avalanche. The mechanisms involved in this avalanche condition can be referenced in literature from the MOSFET suppliers.

¹ Flex-Mode™ is protected by U.S. Patent 6683441.

The MOSFET vendor should provide a maximum voltage slew rate at drain current rating such that this can be designed around. Once this specification is obtained, determine the maximum current expected in the MOSFET. This can be done with the following equation:

$$I_{MAX} = I_{DC} (\text{per phase}) + (V_{CC} - V_{OUT}) \times \frac{D_{MAX}}{f_{MAX} \times L_{OUT}} \quad (5)$$

where:

D_{MAX} is determined for the VR controller being used with the driver. This current is divided roughly equally between MOSFETs if more than one is used (assume a worst-case mismatch of 30% for design margin).

L_{OUT} is the output inductor value.

When producing the design, there is no exact method for calculating the dV/dt due to the parasitic effects in the external MOSFETs as well as the PCB. However, it can be measured to determine if it is safe. If it appears that the dV/dt is too fast, an optional gate resistor can be added between DRVH and the high-side MOSFETs. This resistor slows down the dV/dt , but it increases the switching losses in the high-side MOSFETs. The ADP3120 has been optimally designed with an internal drive impedance that works with most MOSFETs to switch them efficiently, yet minimizes dV/dt . However, some high speed MOSFETs may require this external gate resistor depending on the currents being switched in the MOSFET.

LOW-SIDE (SYNCHRONOUS) MOSFETS

The low-side MOSFETs are usually selected to have a low on resistance to minimize conduction losses. This usually implies a large input gate capacitance and gate charge. The first concern is to make sure the power delivery from the ADP3120 DRVL does not exceed the thermal rating of the driver (see the ADP3186 or ADP3188 data sheet for Flex-Mode controller details).

The next concern for the low-side MOSFETs is to prevent them from being switched on inadvertently when the high-side MOSFET turns on. This occurs due to the drain-gate (Miller, also specified as C_{rss}) capacitance of the MOSFET. When the drain of the low-side MOSFET is switched to VCC by the high-side turning on (at a dV/dt rate), the internal gate of the low-side MOSFET is pulled up by an amount roughly equal to $V_{CC} \times (C_{rss}/C_{iss})$. It is important to make sure this does not put the MOSFET into conduction.

Another consideration is the nonoverlap circuitry of the ADP3120, which attempts to minimize the nonoverlap period. During the state of the high-side turning off to low-side turning on, the SW pin is monitored (as well as the conditions of SW prior to switching) to adequately prevent overlap.

However, during the low-side turn off to high-side turn on, the SW pin does not contain information for determining the proper switching time, so the state of the DRVL pin is

monitored to go below one sixth of VCC. Then a delay is added. Due to the Miller capacitance and internal delays of the low-side MOSFET gate, one must ensure that the Miller-to-input capacitance ratio is low enough and that the low-side MOSFET internal delays are not so large as to allow accidental turn on of the low-side when the high-side turns on.

Contact ADI for an updated list of recommended low-side MOSFETs.

PC BOARD LAYOUT CONSIDERATIONS

Use these general guidelines when designing printed circuit boards:

- Trace out the high current paths and use short, wide (>20 mil) traces to make these connections.
- Minimize trace inductance between DRVH and DRVL outputs and MOSFET gates.
- Connect the PGND pin of the ADP3120 as closely as possible to the source of the lower MOSFET.
- Locate the VCC bypass capacitor as close as possible to the VCC and PGND pins.
- Use vias to other layers when possible to maximize thermal conduction away from the IC.

The circuit in Figure 16 shows how four drivers can be combined with an ADP3188 to form a total power conversion solution for generating $V_{CC(CORE)}$ for an Intel CPU that is VRD 10.x-compliant.

Figure 15 shows an example of the typical land patterns based on the guidelines given previously. For more detailed layout guidelines for a complete CPU voltage regulator subsystem, refer to the PC Board Layout Considerations section of the ADP3188 data sheet.

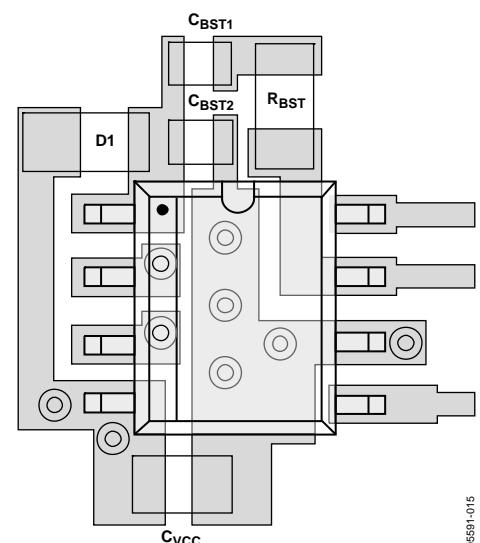
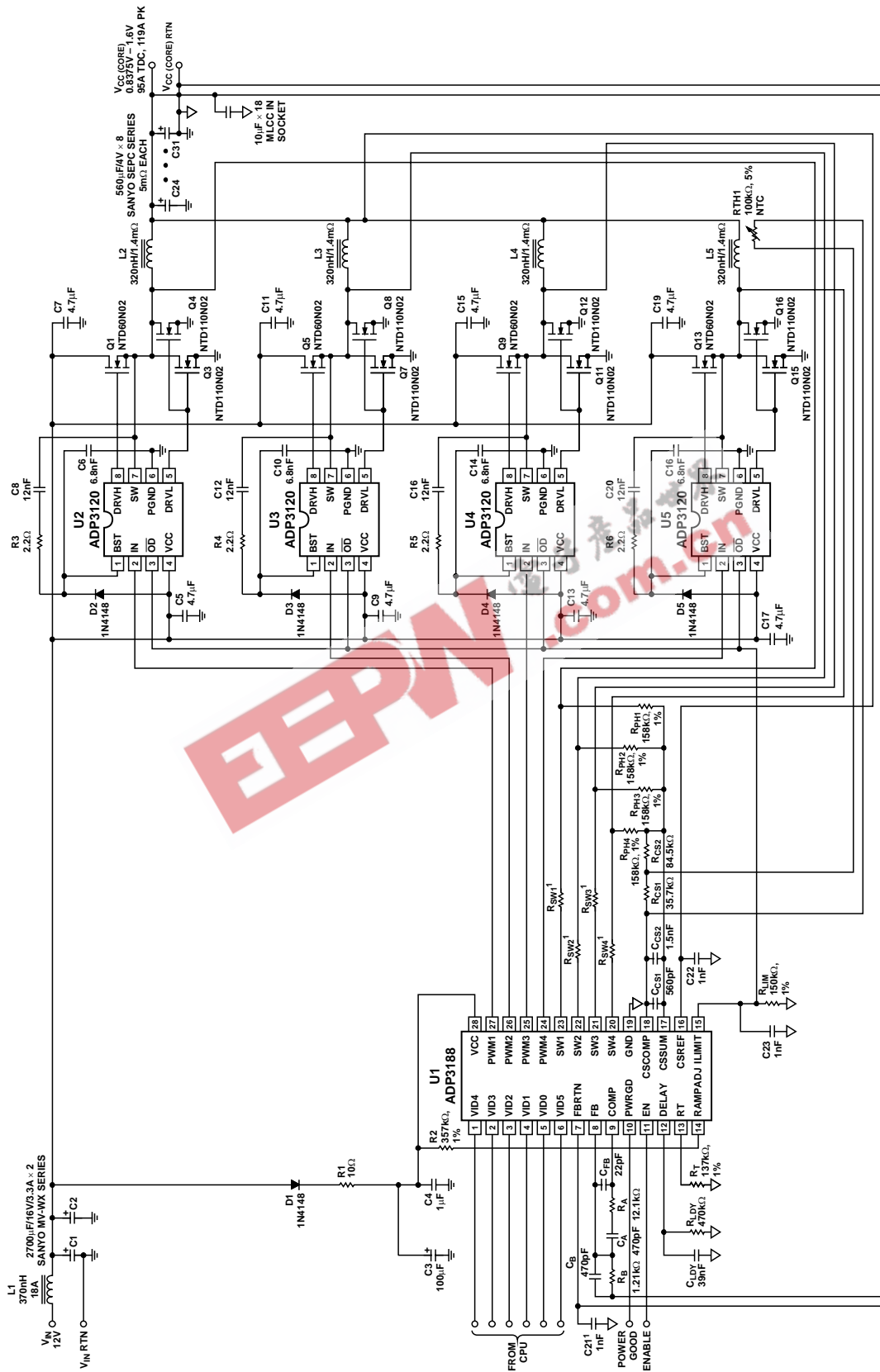

Figure 15. External Component Placement Example

ADP3120



NOTE:
1. FOR A DESCRIPTION OF OPTIONAL COMPONENTS, SEE THE ADP3188 THEORY OF OPERATION SECTION.

06/09/10/16

Figure 16. VRD 10.x-Compliant Power Supply Circuit

OUTLINE DIMENSIONS

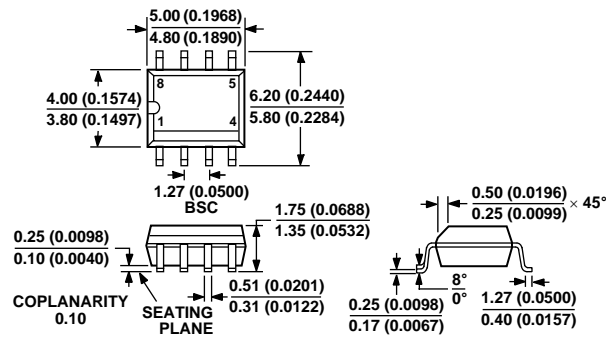

COMPLIANT TO JEDEC STANDARDS MS-012-AA
 CONTROLLING DIMENSIONS ARE IN MILLIMETERS; INCH DIMENSIONS (IN PARENTHESES) ARE ROUNDED-OFF MILLIMETER EQUIVALENTS FOR REFERENCE ONLY AND ARE NOT APPROPRIATE FOR USE IN DESIGN

Figure 17. 8-Lead Standard Small Outline Package [SOIC_N] Narrow Body (R-8)
 Dimensions shown in millimeters (inches)

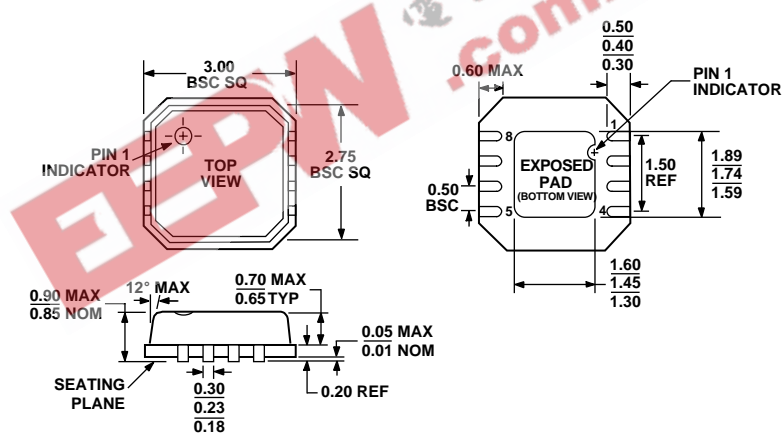

Figure 18. 8-Lead Lead Frame Chip Scale Package [LFCSP_VD] 3 mm x 3 mm Body, Very Thin, Dual-Lead (CP-8-2)
 Dimensions shown in millimeters

ORDERING GUIDE

Model	Temperature Range	Package Description	Package Option	Quantity per Reel	Branding
ADP3120JRZ ¹	0°C to 85°C	8-Lead Standard Small Outline Package (SOIC_N)	R-8	N/A	
ADP3120JRZ-RL	0°C to 85°C	8-Lead Standard Small Outline Package(SOIC_N)	R-8	2500	
ADP3120JCPZ-RL	0°C to 85°C	8-Lead Lead Frame Chip Scale Package (LFCSP_VD)	CP-8-2	2500	L14

¹ Z = Pb-free part.

ADP3120

NOTES

EEPW 电子产品世界
.com.cn

NOTES



ADP3120

NOTES

EEPW 电子产品世界
.com.cn