



AM26LS30

Advance Information

Dual Differential (EIA-422-A)/ Quad Single-Ended (EIA-423-A) Line Drivers

The AM26LS30 is a low power Schottky set of line drivers which can be configured as two differential drivers which comply with EIA-422-A standards, or as four single-ended drivers which comply with EIA-423-A standards. A mode select pin and appropriate choice of power supplies determine the mode. Each driver can source and sink currents in excess of 50 mA.

In the differential mode (EIA-422-A), the drivers can be used up to 10 Mbaud. A disable pin for each driver permits setting the outputs into a high impedance mode within a ± 10 V common mode range.

In the single-ended mode (EIA-423-A), each driver has a slew rate control pin which permits setting the slew rate of the output signal so as to comply with EIA-423-A and FCC requirements and to reduce crosstalk. When operated from symmetrical supplies (± 5.0 V), the outputs exhibit zero imbalance.

The AM26LS30 is available in a 16-pin plastic DIP and surface mount package. Operating temperature range is -40° to $+85^{\circ}\text{C}$.

- Operates as Two Differential EIA-422-A Drivers, or Four Single-Ended EIA-423-A Drivers
- High Impedance Outputs in Differential Mode
- Short Circuit Current Limit In Both Source and Sink Modes
- ± 10 V Common Mode Range on High Impedance Outputs
- ± 15 V Range on Inputs
- Low Current PNP Inputs Compatible with TTL, CMOS, and MOS Outputs
- Individual Output Slew Rate Control in Single-Ended Mode
- Replacement for the AMD AM25LS30 and National Semiconductor DS3691

DUAL DIFFERENTIAL/ QUAD SINGLE-ENDED LINE DRIVERS

SEMICONDUCTOR TECHNICAL DATA

PC SUFFIX
PLASTIC PACKAGE
CASE 648

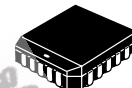
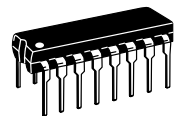

FN SUFFIX
PLASTIC PACKAGE
CASE 775

D SUFFIX
PLASTIC PACKAGE
CASE 751B
(SO-16)

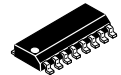

PIN CONNECTIONS

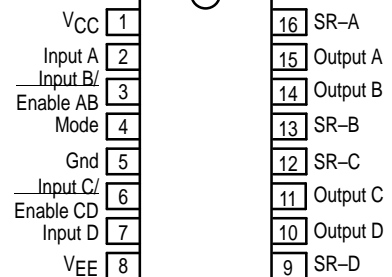

(Top View)

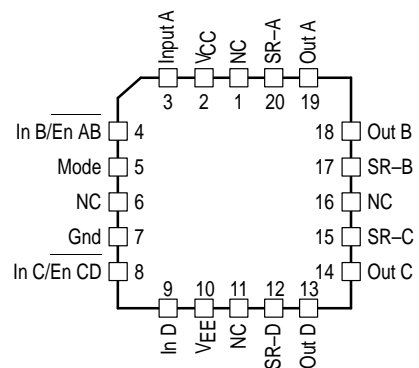

Representative Block Diagrams

Single-Ended Mode EIA-423-A

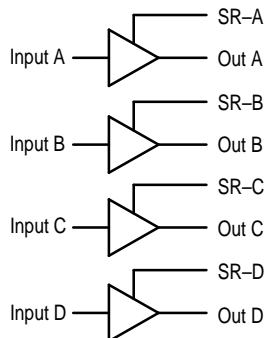

Differential Mode EIA-422-A

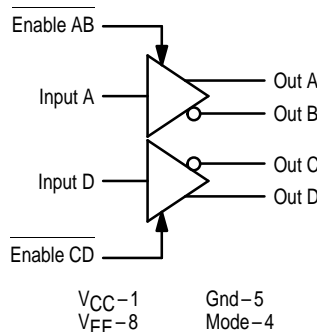

ORDERING INFORMATION

Device	Operating Temperature Range	Package
AM26LS30PC	$T_A = -40^{\circ}$ to $+85^{\circ}\text{C}$	Plastic DIP
MC26LS30D		SO-16
AM26LS30FN		PLCC-20

AM26LS30

MAXIMUM OPERATING CONDITIONS (Pin numbers refer to DIP and SO-16 packages only.)

Rating	Symbol	Value	Unit
Power Supply Voltage	V_{CC} V_{EE}	-0.5, +7.0 -7.0, +0.5	Vdc
Input Voltage (All Inputs)	V_{in}	-0.5, +20	Vdc
Applied Output Voltage when in High Impedance Mode ($V_{CC} = 5.0$ V, Pin 4 = Logic 0, Pins 3, 6 = Logic 1)	V_{za}	± 15	Vdc
Output Voltage with $V_{CC}, V_{EE} = 0$ V	V_{zb}	± 15	
Output Current	I_O	Self limiting	-
Junction Temperature	T_J	-65, +150	$^{\circ}\text{C}$

Devices should not be operated at these limits. The "Recommended Operating Conditions" table provides conditions for actual device operation.

RECOMMENDED OPERATING CONDITIONS

Rating	Symbol	Min	Typ	Max	Unit
Power Supply Voltage (Differential Mode)	V_{CC} V_{EE}	+4.75 -0.5	5.0 0	+5.25 +0.3	Vdc
Power Supply Voltage (Single-Ended Mode)	V_{CC} V_{EE}	+4.75 -5.25	+5.0 -5.0	+5.25 -4.75	
Input Voltage (All Inputs)	V_{in}	0	-	+15	Vdc
Applied Output Voltage (when in High Impedance Mode)	V_{za}	-10	-	+10	
Applied Output Voltage, $V_{CC} = 0$	V_{zb}	-10	-	+10	
Output Current	I_O	-65	-	+65	mA
Operating Ambient Temperature (See text)	T_A	-40	-	+85	$^{\circ}\text{C}$

All limits are not necessarily functional concurrently.

ELECTRICAL CHARACTERISTICS (EIA-422-A differential mode, Pin 4 ≤ 0.8 V, $-40^{\circ}\text{C} < T_A < 85^{\circ}\text{C}$, 4.75 V $\leq V_{CC} \leq 5.25$ V, $V_{EE} = \text{Gnd}$, unless otherwise noted. Pin numbers refer to DIP and SO-16 packages only.)

Characteristic	Symbol	Min	Typ	Max	Unit
Output Voltage (see Figure 1)					
Differential, $R_L = \infty$, $V_{CC} = 5.25$ V	$ V_{OD1} $	-	4.2	6.0	Vdc
Differential, $R_L = 100 \Omega$, $V_{CC} = 4.75$ V	$ V_{OD2} $	2.0	2.6	-	Vdc
Change in Differential Voltage, $R_L = 100 \Omega$ (Note 4)	$ \Delta V_{OD2} $	-	10	400	mVdc
Offset Voltage, $R_L = 100 \Omega$	V_{OS}	-	2.5	3.0	Vdc
Change in Offset Voltage*, $R_L = 100 \Omega$	$ \Delta V_{OS} $	-	10	400	mVdc
Output Current (each output)					
Power Off Leakage, $V_{CC} = 0$, -10 V $\leq V_O \leq +10$ V	I_{OLK}	-100	0	+100	μA
High Impedance Mode, $V_{CC} = 5.25$ V, -10 V $\leq V_O \leq +10$ V	I_{OZ}	-100	0	+100	
Short Circuit Current (Note 2)					
High Output Shorted to Pin 5 ($T_A = 25^{\circ}\text{C}$)	I_{SC-}	-150	-95	-60	mA
High Output Shorted to Pin 5 ($-40^{\circ}\text{C} < T_A < +85^{\circ}\text{C}$)	I_{SC-}	-150	-	-50	
Low Output Shorted to +6.0 V ($T_A = 25^{\circ}\text{C}$)	I_{SC+}	60	75	150	
Low Output Shorted to +6.0 V ($-40^{\circ}\text{C} < T_A < +85^{\circ}\text{C}$)	I_{SC+}	50	-	150	
Inputs					
Low Level Voltage	V_{IL}	-	-	0.8	Vdc
High Level Voltage	V_{IH}	2.0	-	-	Vdc
Current @ $V_{in} = 2.4$ V	I_{IH}	-	0	40	μA
Current @ $V_{in} = 15$ V	I_{IHH}	-	0	100	
Current @ $V_{in} = 0.4$ V	I_{IL}	-200	-8.0	-	
Current, $0 \leq V_{in} \leq 15$ V, $V_{CC} = 0$	I_{IX}	-	0	-	
Clamp Voltage ($I_{in} = -12$ mA)	V_{IK}	-1.5	-	-	Vdc
Power Supply Current ($V_{CC} = +5.25$ V, Outputs Open) ($0 \leq \text{Enable} \leq V_{CC}$)	I_{CC}	-	16	30	mA

- NOTES:**
1. All voltages measured with respect to Pin 5.
 2. Only one output shorted at a time, for not more than 1 second.
 3. Typical values established at $+25^{\circ}\text{C}$, $V_{CC} = +5.0$ V, $V_{EE} = -5.0$ V.
 4. V_{in} switched from 0.8 to 2.0 V.
 5. Imbalance is the difference between $|V_{O2}|$ with $V_{in} < 0.8$ V and $|V_{O2}|$ with $V_{in} > 2.0$ V.

AM26LS30

TIMING CHARACTERISTICS (EIA-422-A differential mode, Pin 4 \leq 0.8 V, $T_A = 25^\circ\text{C}$, $V_{CC} = 5.0\text{ V}$, $V_{EE} = \text{Gnd}$, (Notes 1 and 3) unless otherwise noted.)

Characteristic	Symbol	Min	Typ	Max	Unit
Differential Output Rise Time (Figure 3)	t_r	–	70	200	ns
Differential Output Fall Time (Figure 3)	t_f	–	70	200	ns
Propagation Delay Time – Input to Differential Output Input Low to High (Figure 3) Input High to Low (Figure 3)	t_{PDH} t_{PDL}	– –	90 90	200 200	ns
Skew Timing (Figure 3) $ t_{PDH} \text{ to } t_{PDL} $ for Each Driver Max to Min t_{PDH} Within a Package Max to Min t_{PDL} Within a Package	t_{SK1} t_{SK2} t_{SK3}	– – –	9.0 2.0 2.0	– – –	ns
Enable Timing (Figure 4) Enable to Active High Differential Output Enable to Active Low Differential Output Enable to 3-State Output From Active High Enable to 3-State Output From Active Low	t_{PZH} t_{PZL} t_{PHZ} t_{PLZ}	– – – –	150 190 80 110	300 350 350 300	ns

ELECTRICAL CHARACTERISTICS (EIA-423-A single-ended mode, Pin 4 \geq 2.0 V, $-40^\circ\text{C} < T_A < 85^\circ\text{C}$, $4.75\text{ V} \leq |V_{CC}|$, $|V_{EE}| \leq 5.25\text{ V}$, (Notes 1 and 3) unless otherwise noted.)

Characteristic	Symbol	Min	Typ	Max	Unit
Output Voltage ($V_{CC} = V_{EE} = 4.75\text{ V}$) Single-Ended Voltage, $R_L = \infty$ (Figure 2) Single-Ended Voltage, $R_L = 450\ \Omega$, (Figure 2) Voltage Imbalance (Note 5), $R_L = 450\ \Omega$	$ V_{O1} $ $ V_{O2} $ $ \Delta V_{O2} $	4.0 3.6 –	4.2 3.95 0.05	6.0 6.0 0.4	Vdc
Slew Control Current (Pins 16, 13, 12, 9)	I_{SLEW}	–	± 120	–	μA
Output Current (Each Output) Power Off Leakage, $V_{CC} = V_{EE} = 0$, $-6.0\text{ V} \leq V_O \leq +6.0\text{ V}$ Short Circuit Current (Output Short to Ground, Note 2) $V_{in} \leq 0.8\text{ V}$ ($T_A = 25^\circ\text{C}$) $V_{in} \leq 0.8\text{ V}$ ($-40^\circ\text{C} < T_A < +85^\circ\text{C}$) $V_{in} \geq 2.0\text{ V}$ ($T_A = 25^\circ\text{C}$) $V_{in} \geq 2.0\text{ V}$ ($-40^\circ\text{C} < T_A < +85^\circ\text{C}$)	I_{OLK} I_{SC+} I_{SC+} I_{SC-} I_{SC-}	–100 60 50 –150 –150	0 80 – –95 –	+100 150 150 –60 –50	μA mA
Inputs Low Level Voltage High Level Voltage Current @ $V_{in} = 2.4\text{ V}$ Current @ $V_{in} = 15\text{ V}$ Current @ $V_{in} = 0.4\text{ V}$ Current, $0 \leq V_{in} \leq 15\text{ V}$, $V_{CC} = 0$ Clamp Voltage ($I_{in} = -12\text{ mA}$)	V_{IL} V_{IH} I_{IH} I_{IHH} I_{IL} I_{IX} V_{IK}	– 2.0 – – –200 – –1.5	– – 0 0 –8.0 0 –	0.8 – 40 100 – – –	Vdc Vdc μA
Power Supply Current (Outputs Open) $V_{CC} = +5.25\text{ V}$, $V_{EE} = -5.25\text{ V}$, $V_{in} = 0.4\text{ V}$	I_{CC} I_{EE}	– –22	17 –8.0	30 –	mA

TIMING CHARACTERISTICS (EIA-423-A single-ended mode, Pin 4 \geq 2.0 V, $T_A = 25^\circ\text{C}$, $V_{CC} = 5.0\text{ V}$, $V_{EE} = -5.0\text{ V}$, (Notes 1 and 3) unless otherwise noted.)

Characteristic	Symbol	Min	Typ	Max	Unit
Output Timing (Figure 5) Output Rise Time, $C_C = 0$ Output Fall Time, $C_C = 0$ Output Rise Time, $C_C = 50\text{ pF}$ Output Fall Time, $C_C = 50\text{ pF}$	t_r t_f t_r t_f	– – – –	65 65 3.0 3.0	300 300 – –	ns μs
Rise Time Coefficient (Figure 16)	C_{rt}	–	0.06	–	$\mu\text{s/pF}$
Propagation Delay Time, Input to Single Ended Output (Figure 5) Input Low to High, $C_C = 0$ Input High to Low, $C_C = 0$	t_{PDH} t_{PDL}	– –	100 100	300 300	ns
Skew Timing, $C_C = 0$ (Figure 5) $ t_{PDH} \text{ to } t_{PDL} $ for Each Driver Max to Min t_{PDH} Within a Package Max to Min t_{PDL} Within a Package	t_{SK4} t_{SK5} t_{SK6}	– – –	15 2.0 5.0	– – –	ns

AM26LS30

Table 1

Operation	V _{CC}	V _{EE}	Inputs				Outputs				
			Mode	A	B	C	D	A	B	C	D
Differential (EIA-422-A)	+5.0	Gnd	0	0	0	0	0	0	1	1	0
			0	1	0	0	1	1	0	0	1
			0	X	1	0	1	Z	Z	0	1
			0	1	0	0	0	1	0	1	0
			0	0	0	0	1	0	1	0	1
			0	1	0	1	X	1	0	Z	Z
Single-Ended (EIA-423-A)	+5.0	-5.0	1	0	0	0	0	0	0	0	0
			1	1	0	0	0	1	0	0	0
			1	0	1	0	0	0	1	0	0
			1	0	0	1	0	0	0	1	0
			1	0	0	0	1	0	0	0	1
X	0	X	X	X	X	X	Z	Z	Z	Z	

X = Don't Care
Z = High Impedance (Off)

Figure 1. Differential Output Test

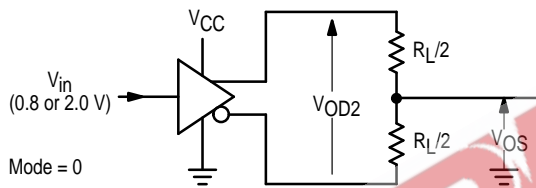

Figure 2. Single-Ended Output Test

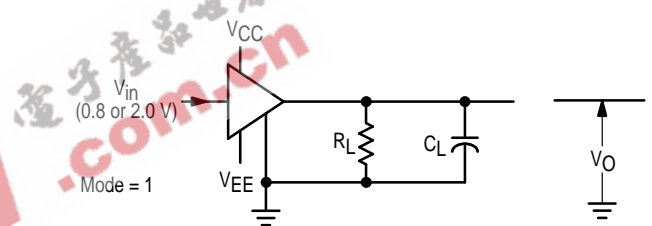
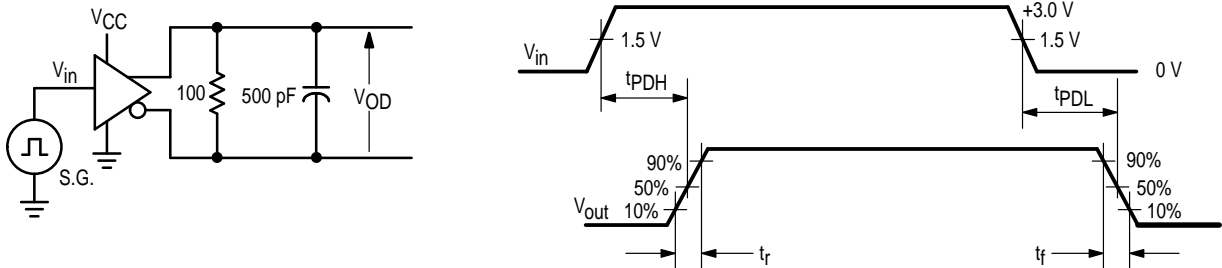

Figure 3. Differential Mode Rise/Fall Time and Data Propagation Delay



- NOTES: 1. S.G. set to: $f \leq 1.0$ MHz; duty cycle = 50%; $t_r, t_f \leq 10$ ns.
 2. $t_{SK1} = |t_{PDH} - t_{PDL}|$ for each driver.
 3. t_{SK2} computed by subtracting the shortest t_{PDH} from the longest t_{PDH} of the 2 drivers within a package.
 4. t_{SK3} computed by subtracting the shortest t_{PDL} from the longest t_{PDL} of the 2 drivers within a package.

AM26LS30

Figure 4. Differential Mode Enable Timing

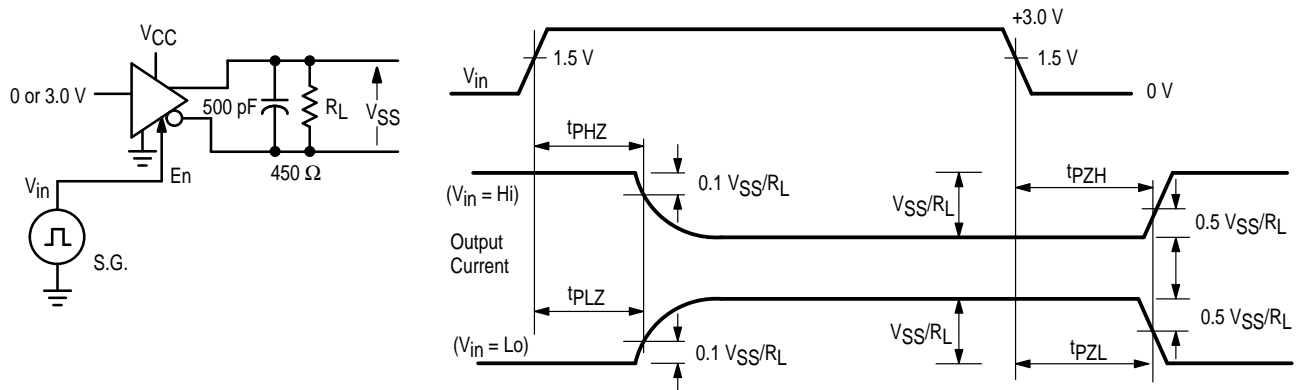

- NOTES: 1. S.G. set to: $f \leq 1.0$ MHz; duty cycle = 50%; $t_r, t_f \leq 10$ ns.
2. Above tests conducted by monitoring output current levels.

Figure 5. Single-Ended Mode Rise/Fall Time and Data Propagation Delay

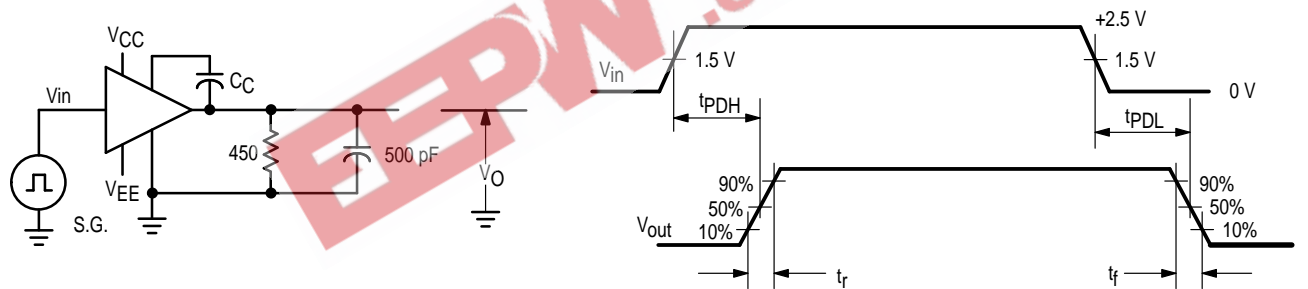

- NOTES: 1. S.G. set to: $f \leq 100$ kHz; duty cycle = 50%; $t_r, t_f \leq 10$ ns.
2. $t_{SK4} = |t_{PDH} - t_{PDL}|$ for each driver.
3. t_{SK5} computed by subtracting the shortest t_{PDH} from the longest t_{PDH} of the 4 drivers within a package.
4. t_{SK6} computed by subtracting the shortest t_{PDL} from the longest t_{PDL} of the 4 drivers within a package.

AM26LS30

Figure 6. Differential Output Voltage versus Load Current

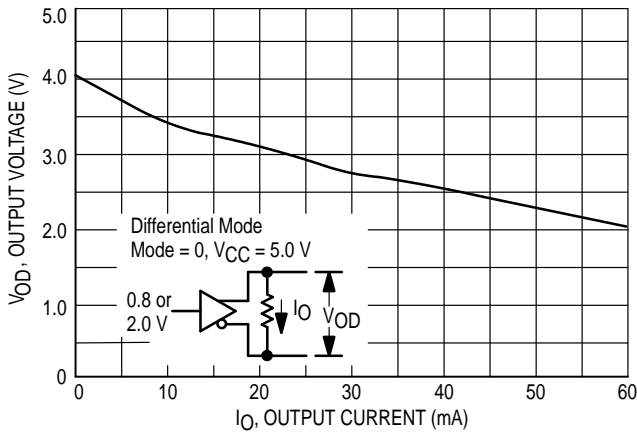

Figure 7. Internal Bias Current versus Load Current

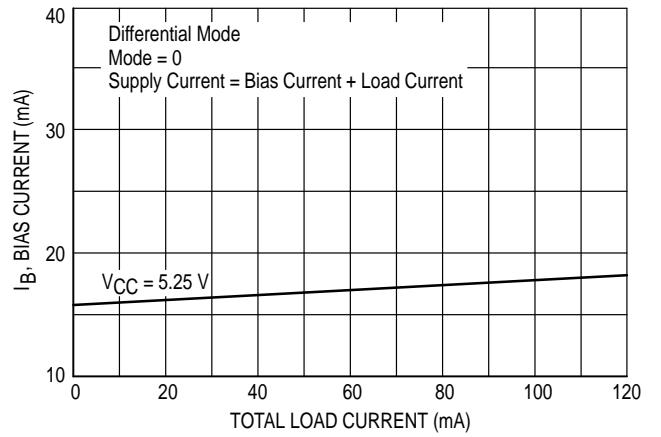

Figure 8. Short Circuit Current versus Output Voltage

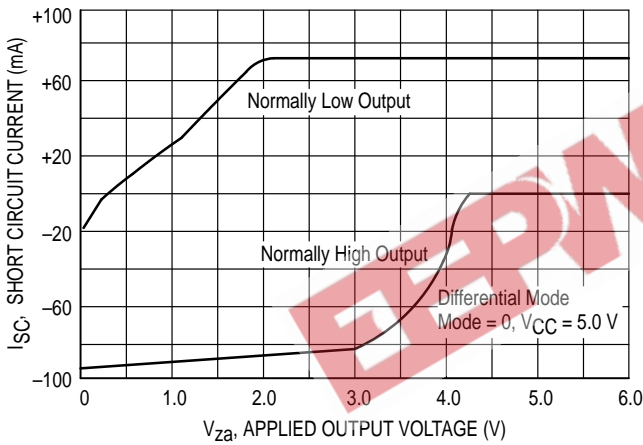

Figure 9. Input Current versus Input Voltage

(Pin numbers refer to DIP and SO-16 packages only.)

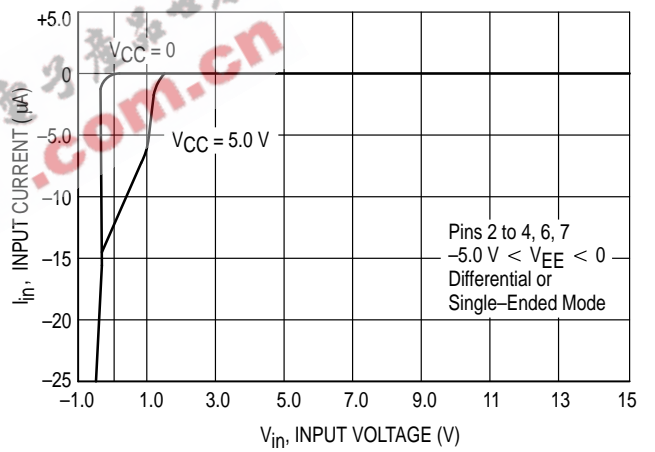

Figure 10. Output Voltage versus Output Source Current

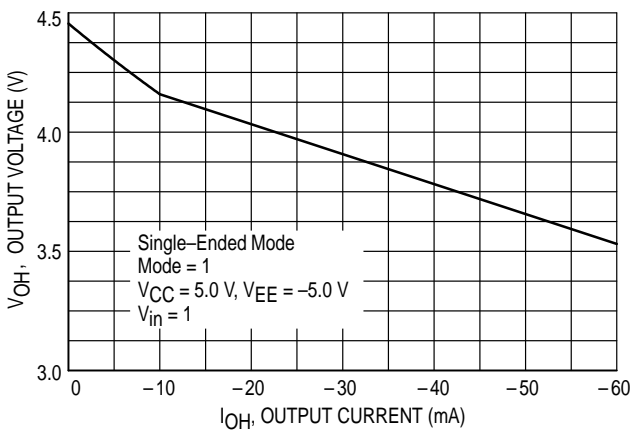
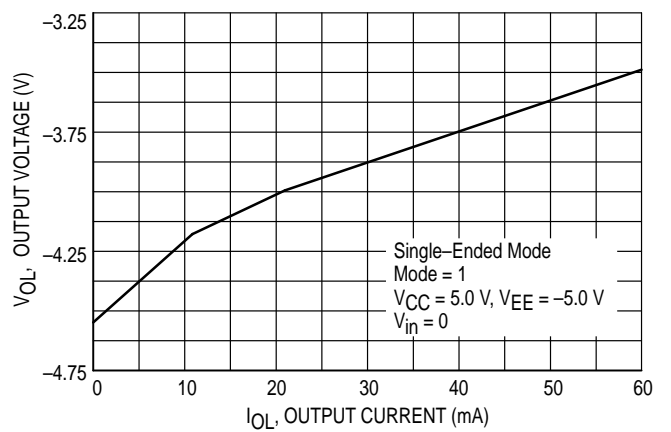

Figure 11. Output Voltage versus Output Sink Current



AM26LS30

Figure 12. Internal Positive Bias Current versus Load Current

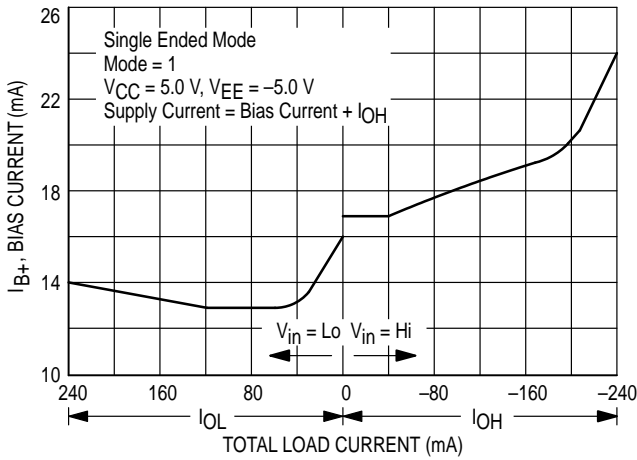

Figure 13. Internal Negative Bias Current versus Load Current

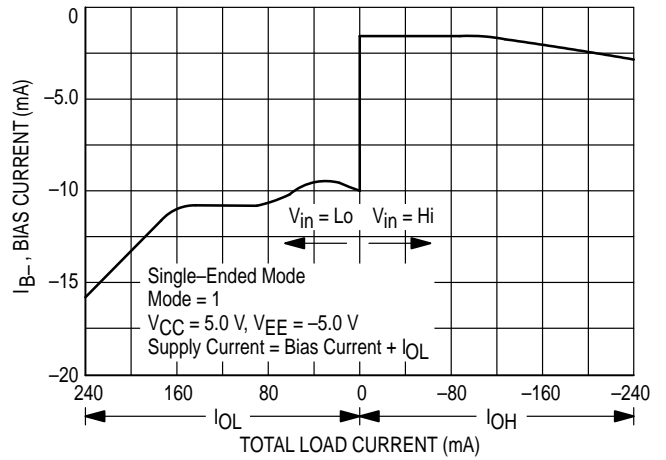

Figure 14. Short Circuit Current versus Output Voltage

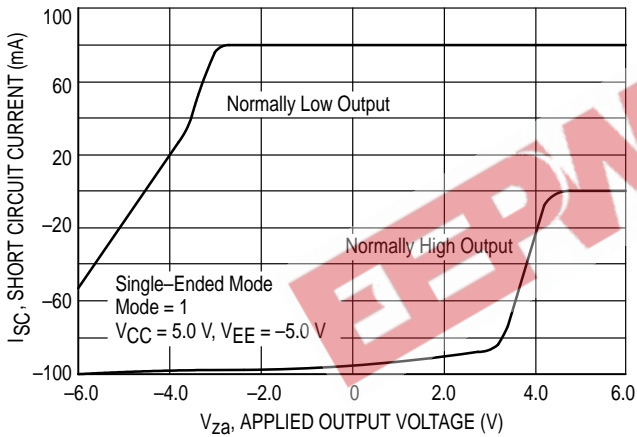

Figure 15. Short Circuit Current versus Temperature

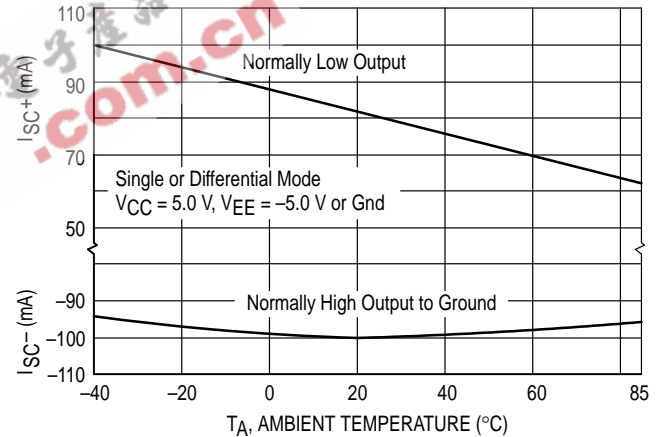
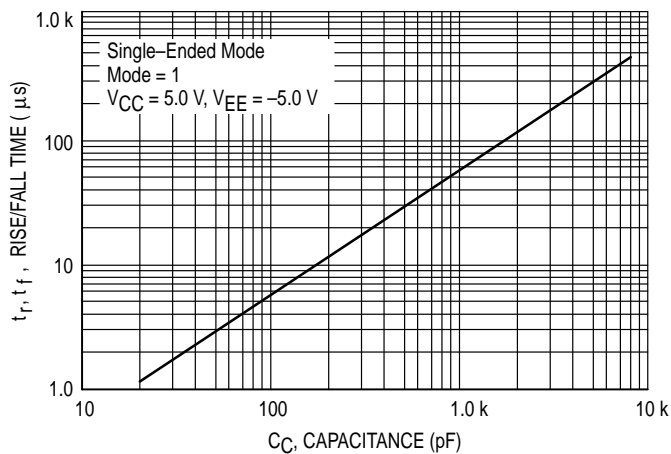

Figure 16. Rise/Fall Time versus Capacitance



AM26LS30

APPLICATIONS INFORMATION

(Pin numbers refer to DIP and SO-16 packages only.)

Description

The AM26LS30 is a dual function line driver – it can be configured as two differential output drivers which comply with EIA-422-A Standard, or as four single-ended drivers which comply with EIA-423-A Standard. The mode of operation is selected with the Mode pin (Pin 4) and appropriate power supplies (see Table 1). Each of the four outputs is capable of sourcing and sinking 60 to 70 mA while providing sufficient voltage to ensure proper data transmission.

As differential drivers, data rates to 10 Mbaud can be transmitted over a twisted pair for a distance determined by the cable characteristics. EIA-422-A Standard provides guidelines for cable length versus data rate. The advantage of a differential (balanced) system over a single-ended system is greater noise immunity, common mode rejection, and higher data rates.

Where extraneous noise sources are not a problem, the AM26LS30 may be configured as four single-ended drivers transmitting data rates to 100 Kbaud. Crosstalk among wires within a cable is controlled by the use of the slew rate control pins on the AM26LS30.

Mode Selection

(Differential Mode)

In this mode (Pins 4 and 8 at ground), only a +5.0 V supply $\pm 5\%$ is required at V_{CC} . Pins 2 and 7 are the driver inputs, while Pins 10, 11, 14 and 15 are the outputs (see Block Diagram on page 1). The two outputs of a driver are always complementary and the differential voltage available at each pair of outputs is shown in Figure 6 for $V_{CC} = 5.0$ V. The differential output voltage will vary directly with V_{CC} . A “high” output can only source current, while a “low” output can only sink current (except for short circuit current – see Figure 8).

The two outputs will be in a high impedance mode when the respective Enable input (Pin 3 or 6) is high, or if $V_{CC} \leq 1.1$ V. Output leakage current over a common mode range of ± 10 V is typically less than 1.0 μ A.

The outputs have short circuit current limiting, typically, less than 100 mA over a voltage range of 0 to +6.0 V (see Figure 8). Short circuits should not be allowed to last indefinitely as the IC may be damaged.

Pins 9, 12, 13 and 16 are not normally used when in this mode, and should be left open.

(Single-Ended Mode)

In this mode (Pin 4 ≥ 2.0 V) V_{CC} requires +5.0 V, and V_{EE} requires -5.0 V, both $\pm 5.0\%$. Pins 2, 3, 6, and 7 are inputs for the four drivers, and Pins 15, 14, 11, and 10 (respectively) are the outputs. The four drivers are independent of each other, and each output will be at a positive or a negative voltage depending on its input state, the load current, and the supply voltage. Figures 10 & 11 indicate the high and low output voltages for $V_{CC} = 5.0$ V, and $V_{EE} = -5.0$ V. The graph of Figure 10 will vary directly with V_{CC} , and the graph of

Figure 11 will vary directly with V_{EE} . A “high” output can only source current, while a “low” output can only sink current (except short circuit current – see Figure 14).

The outputs will be in a high impedance mode only if $V_{CC} \leq 1.1$ V. Changing V_{EE} to 0 V does not set the outputs to a high impedance mode. Leakage current over a common mode range of ± 10 V is typically less than 1.0 μ A.

The outputs have short circuit current limiting, typically less than 100 mA over a voltage range of ± 6.0 V (see Figure 14). Short circuits should not be allowed to last indefinitely as the IC may be damaged.

Capacitors connected between Pins 9, 12, 13, and 16 and their respective outputs will provide slew rate limiting of the output transition. Figure 16 indicates the required capacitor value to obtain a desired rise or fall time (measured between the 10% and 90% points). The positive and negative transition times will be within $\approx \pm 5\%$ of each other. Each output may be set to a different slew rate if desired.

Inputs

The five inputs determine the state of the outputs in accordance with Table 1. All inputs (regardless of the operating mode) have a nominal threshold of +1.3 V, and their voltage must be kept within a range of 0 V to +15 V for proper operation. If an input is taken more than 0.3 V below ground, excessive currents will flow, and the proper operation of the drivers will be affected. An open pin is equivalent to a logic high, but good design practices dictate that inputs should never be left open. Unused inputs should be connected to ground. The characteristics of the inputs are shown in Figure 9.

Power Supplies

V_{CC} requires +5.0 V, $\pm 5\%$, regardless of the mode of operation. The supply current is determined by the IC's internal bias requirements and the total load current. The internally required current is a function of the load current and is shown in Figure 7 for the differential mode.

In the single-ended mode, V_{EE} must be -5.0 V, $\pm 5\%$ in order to comply with EIA-423-A standards. Figures 12 and 13 indicate the internally required bias currents as a function of total load current (the sum of the four output loads). The discontinuity at 0 load current exists due to a change in bias current when the inputs are switched. The supply currents vary $\approx \pm 2.0$ mA as V_{CC} and V_{EE} are varied from $|4.75$ V| to $|5.25$ V|.

Sequencing of the supplies during power-up/power-down is not required.

Bypass capacitors (0.1 μ F minimum on each supply pin) are recommended to ensure proper operation. Capacitors reduce noise induced onto the supply lines by the switching action of the drivers, particularly where long P.C. board tracks are involved. Additionally, the capacitors help absorb transients induced onto the drivers' outputs from the external cable (from ESD, motor noise, nearby computers, etc.).

AM26LS30

Operating Temperature Range

The maximum ambient operating temperature, listed as +85°C, is actually a function of the system use (i.e., specifically how many drivers within a package are used) and at what current levels they are operating. The maximum power which may be dissipated within the package is determined by:

$$P_{Dmax} = \frac{T_{Jmax} - T_A}{R_{\theta JA}}$$

where $R_{\theta JA}$ = package thermal resistance which is typically:
 67°C/W for the DIP (PC) package,
 120°C/W for the SOIC (D) package,
 T_{Jmax} = max. allowable junction temperature (150°C)
 T_A = ambient air temperature near the IC package.

1) Differential Mode Power Dissipation

For the differential mode, the power dissipated within the package is calculated from:

$$P_D = [(V_{CC} - V_{OD}) \times I_O] \text{ (each driver)} + (V_{CC} \times I_B)$$

where: V_{CC} = the supply voltage
 V_{OD} = is taken from Figure 6 for the known value of I_O
 I_B = the internal bias current (Figure 7)

As indicated in the equation, the first term (in brackets) must be calculated and summed for each of the two drivers, while the last term is common to the entire package. Note that the term $(V_{CC} - V_{OD})$ is constant for a given value of I_O and does not vary with V_{CC} . For an application involving the following conditions:

$T_A = +85^\circ\text{C}$, $I_O = -60 \text{ mA}$ (each driver), $V_{CC} = 5.25 \text{ V}$, the suitability of the package types is calculated as follows.

The power dissipated is:

$$P_D = [3.0 \text{ V} \times 60 \text{ mA} \times 2] + (5.25 \text{ V} \times 18 \text{ mA})$$

$$P_D = 454 \text{ mW}$$

The junction temperature calculates to:

$$T_J = 85^\circ\text{C} + (0.454 \text{ W} \times 67^\circ\text{C/W}) = 115^\circ\text{C} \text{ for the DIP package,}$$

$$T_J = 85^\circ\text{C} + (0.454 \text{ W} \times 120^\circ\text{C/W}) = 139^\circ\text{C} \text{ for the SOIC package.}$$

Since the maximum allowable junction temperature is not exceeded in any of the above cases, either package can be used in this application.

2) Single-Ended Mode Power Dissipation

For the single-ended mode, the power dissipated within the package is calculated from:

$$P_D = (I_{B+} \times V_{CC}) + (I_{B-} \times V_{EE}) + [I_O \times (V_{CC} - V_{OH})] \text{ (each driver)}$$

The above equation assumes I_O has the same magnitude for both output states, and makes use of the fact that the absolute value of the graphs of Figures 10 and 11 are nearly identical. I_{B+} and I_{B-} are obtained from the right half of Figures 12 and 13, and $(V_{CC} - V_{OH})$ can be obtained from Figure 10. Note that the term $(V_{CC} - V_{OH})$ is constant for a given value of I_O and does not vary with V_{CC} . For an application involving the following conditions:

$T_A = +85^\circ\text{C}$, $I_O = -60 \text{ mA}$ (each driver), $V_{CC} = 5.25 \text{ V}$, $V_{EE} = -5.25 \text{ V}$, the suitability of the package types is calculated as follows.

The power dissipated is:

$$P_D = (24 \text{ mA} \times 5.25 \text{ V}) + (-3.0 \text{ mA} \times -5.25 \text{ V}) + [60 \text{ mA} \times 1.45 \text{ V} \times 4.0]$$

$$P_D = 490 \text{ mW}$$

The junction temperature calculates to:

$$T_J = 85^\circ\text{C} + (0.490 \text{ W} \times 67^\circ\text{C/W}) = 118^\circ\text{C} \text{ for the DIP package,}$$

$$T_J = 85^\circ\text{C} + (0.490 \text{ W} \times 120^\circ\text{C/W}) = 144^\circ\text{C} \text{ for the SOIC package.}$$

Since the maximum allowable junction temperature is not exceeded in any of the above cases, either package can be used in this application.

AM26LS30

SYSTEM EXAMPLES

(Pin numbers refer to DIP and SO-16 packages only.)

Differential System

An example of a typical EIA-422-A system is shown in Figure 17. Although EIA-422-A does not specifically address multiple driver situations, the AM26LS30 can be used in this manner since the outputs can be put into a high impedance mode. It is, however, the system designer's responsibility to ensure the Enable pins are properly controlled so as to prevent two drivers on the same cable from being "on" at the same time.

The limit on the number of receivers and drivers which may be connected on one system is determined by the input current of each receiver, the maximum leakage current of each "off" driver, and the DC current through each terminating resistor. The sum of these currents must not exceed the capability of the "on" driver (≈ 60 mA). If the cable is of any significant length, with receivers at various points along its length, the common mode voltage may vary along its length, and this parameter must be considered when calculating the maximum driver current.

The cable requirements are defined not only by the AC characteristics and the data rate, but also by the DC resistance. The maximum resistance must be such that the minimum voltage across any receiver inputs is never less than 200 mV.

The ground terminals of each driver and receiver in Figure 17 must be connected together by a dedicated wire (or the shield) in the cable to provide a common reference. Chassis grounds or power line grounds should not be relied on for this common connection as they may generate significant common mode differences. Additionally, they usually do not provide a sufficiently low impedance at the frequencies of interest.

Single-Ended System

An example of a typical EIA-423-A system is shown in Figure 18. Multiple drivers on a single data line are not possible since the drivers cannot be put into a high impedance mode. Although each driver is shown connected to a single receiver, multiple receivers can be driven from a single driver as long as the total load current of the receivers and the terminating resistor does not exceed the capability of the driver (≈ 60 mA). If the cable is of any significant length, with receivers at various points along its length, the common mode voltage may vary along its length, and this parameter must be considered when calculating the maximum driver current.

The cable requirements are defined not only by the AC characteristics and the data rate, but also by the DC resistance. The maximum resistance must be such that the

minimum voltage across any receiver inputs is never less than 200 mV.

The ground terminals of each driver and receiver in Figure 18 must be connected together by a dedicated wire (or the shield) in the cable so as to provide a common reference. Chassis grounds or power line grounds should not be relied on for this common connection as they may generate significant common mode differences. Additionally, they usually do not provide a sufficiently low impedance at the frequencies of interest.

Additional Modes of Operation

If compliance with EIA-422-A or EIA-423-A Standard is not required in a particular application, the AM26LS30 can be operated in two other modes.

1) The device may be operated in the differential mode (Pin 4 = 0) with V_{EE} connected to any voltage between ground and -5.25 V. Outputs in the low state will be referenced to V_{EE} , resulting in a differential output voltage greater than that shown in Figure 6. The Enable pins will operate the same as previously described.

2) The device may be operated in the single-ended mode (Pin 4 = 1) with V_{EE} connected to any voltage between ground and -5.25 V. Outputs in the high state will be at a voltage as shown in Figure 10, while outputs in a low state will be referenced to V_{EE} .

Termination Resistors

Transmission line theory states that, in order to preserve the shape and integrity of a waveform traveling along a cable, the cable must be terminated in an impedance equal to its characteristic impedance. In a system such as that depicted in Figure 17, in which data can travel in both directions, both physical ends of the cable must be terminated. Stubs leading to each receiver and driver should be as short as possible.

In a system such as that depicted in Figure 18, in which data normally travels in one direction only, a terminator is theoretically required only at the receiving end of the cable. However, if the cable is in a location where noise spikes of several volts can be induced onto it, then a terminator (preferably a series resistor) should be placed at the driver end to prevent damage to the driver.

Leaving off the terminations will generally result in reflections which can have amplitudes of several volts above V_{CC} or several volts below ground or V_{EE} . These overshoots/undershoots can disrupt the driver and/or receiver, create false data, and in some cases, damage components on the bus.

AM26LS30

Figure 17. EIA-422-A Example

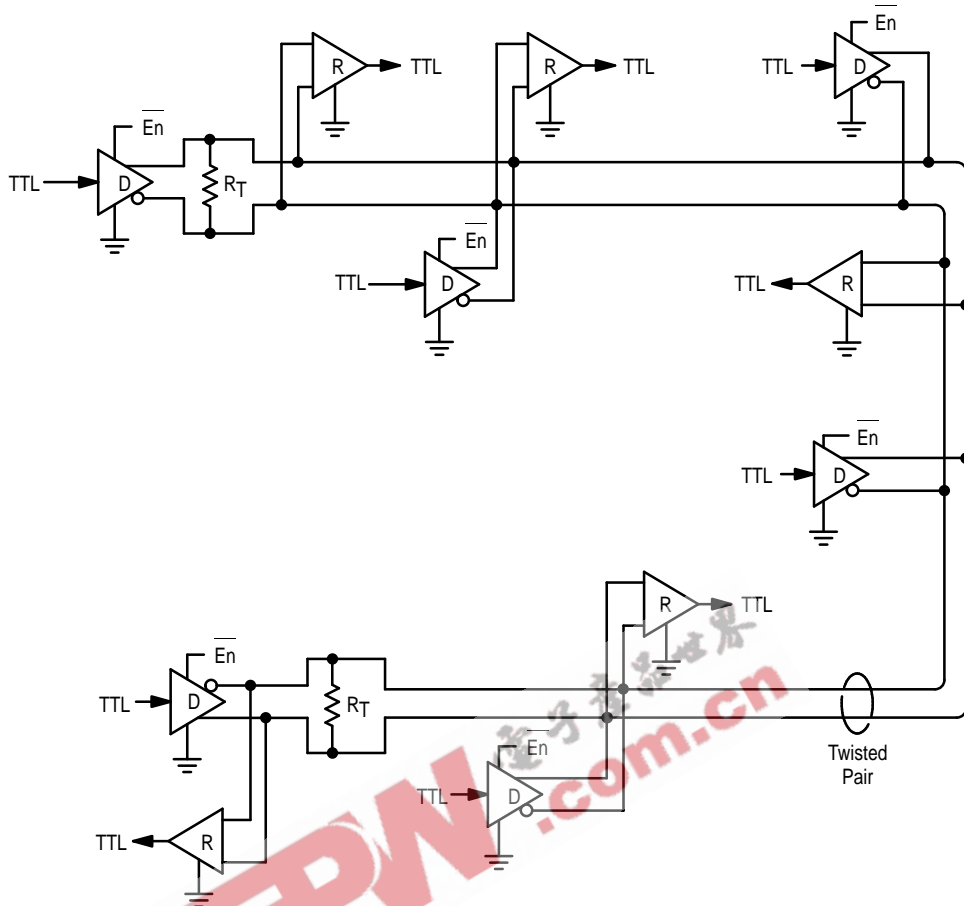

- NOTES:**
1. Terminating resistors R_T should be located at the physical ends of the cable.
 2. Stubs should be as short as possible.
 3. Receivers = AM26LS32, MC3486, SN75173 or SN75175.
 4. Circuit grounds must be connected together through a dedicated wire.

Figure 18. EIA-423-A Example

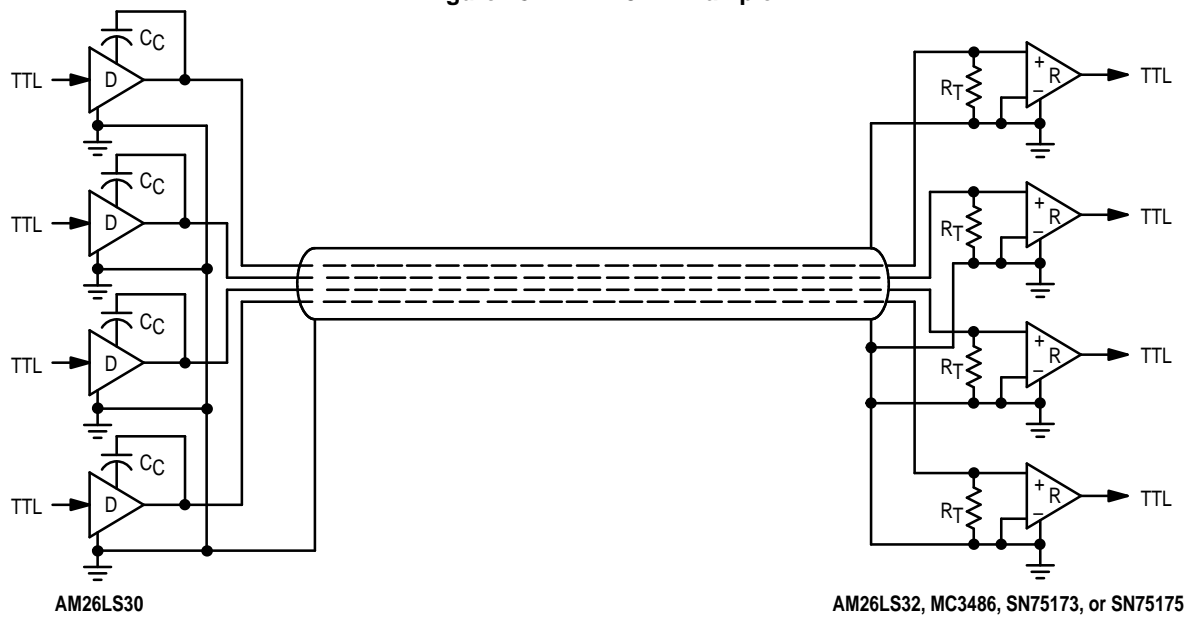

AM26LS30

OUTLINE DIMENSIONS

PC SUFFIX PLASTIC PACKAGE CASE 648-08 ISSUE R

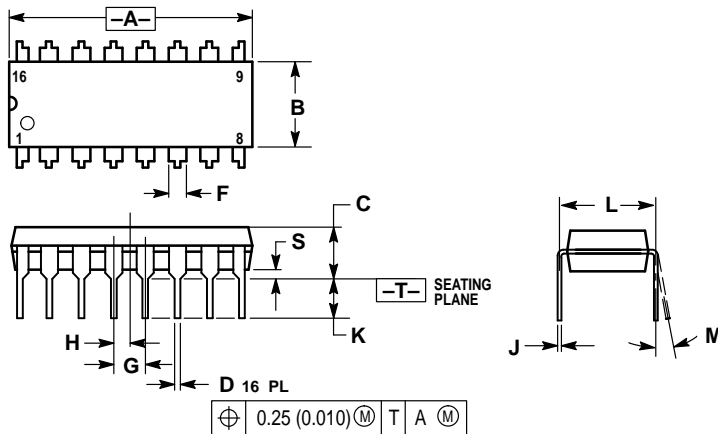

NOTES:

1. DIMENSIONING AND TOLERANCING PER ANSI Y14.5M, 1982.
2. CONTROLLING DIMENSION: INCH.
3. DIMENSION L TO CENTER OF LEADS WHEN FORMED PARALLEL.
4. DIMENSION B DOES NOT INCLUDE MOLD FLASH.
5. ROUNDED CORNERS OPTIONAL.

DIM	INCHES		MILLIMETERS	
	MIN	MAX	MIN	MAX
A	0.740	0.770	18.80	19.55
B	0.250	0.270	6.35	6.85
C	0.145	0.175	3.69	4.44
D	0.015	0.021	0.39	0.53
F	0.040	0.70	1.02	1.77
G	0.100 BSC		2.54 BSC	
H	0.050 BSC		1.27 BSC	
J	0.008	0.015	0.21	0.38
K	0.110	0.130	2.80	3.30
L	0.295	0.305	7.50	7.74
M	0°	10°	0°	10°
S	0.020	0.040	0.51	1.01

D SUFFIX PLASTIC PACKAGE CASE 751B-05 (SO-16) ISSUE J

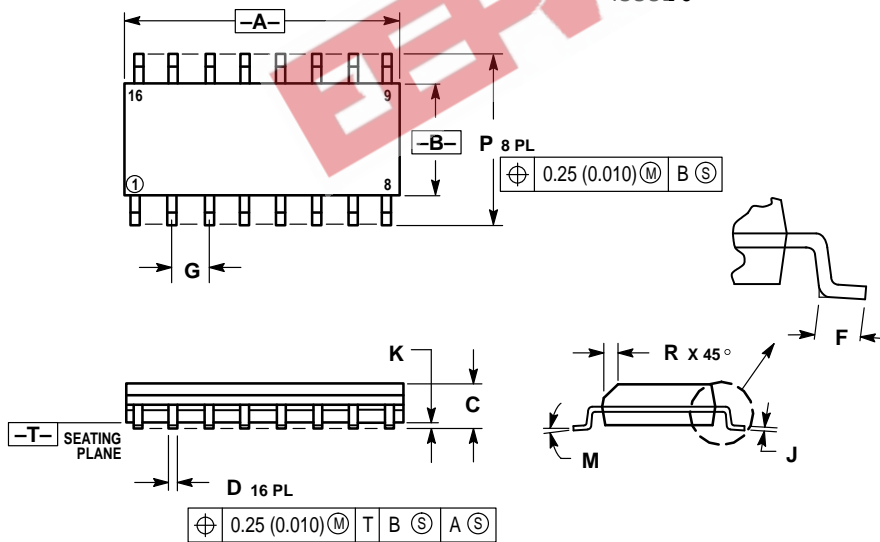

NOTES:

1. DIMENSIONING AND TOLERANCING PER ANSI Y14.5M, 1982.
2. CONTROLLING DIMENSION: MILLIMETER.
3. DIMENSIONS A AND B DO NOT INCLUDE MOLD PROTRUSION.
4. MAXIMUM MOLD PROTRUSION 0.15 (0.006) PER SIDE.
5. DIMENSION D DOES NOT INCLUDE DAMBAR PROTRUSION. ALLOWABLE DAMBAR PROTRUSION SHALL BE 0.127 (0.005) TOTAL IN EXCESS OF THE D DIMENSION AT MAXIMUM MATERIAL CONDITION.

DIM	MILLIMETERS		INCHES	
	MIN	MAX	MIN	MAX
A	9.80	10.00	0.386	0.393
B	3.80	4.00	0.150	0.157
C	1.35	1.75	0.054	0.068
D	0.35	0.49	0.014	0.019
F	0.40	1.25	0.016	0.049
G	1.27 BSC		0.050 BSC	
J	0.19	0.25	0.008	0.009
K	0.10	0.25	0.004	0.009
M	0°	7°	0°	7°
P	5.80	6.20	0.229	0.244
R	0.25	0.50	0.010	0.019

AM26LS30

OUTLINE DIMENSIONS

FN SUFFIX
PLASTIC PACKAGE
CASE 775-02
ISSUE C

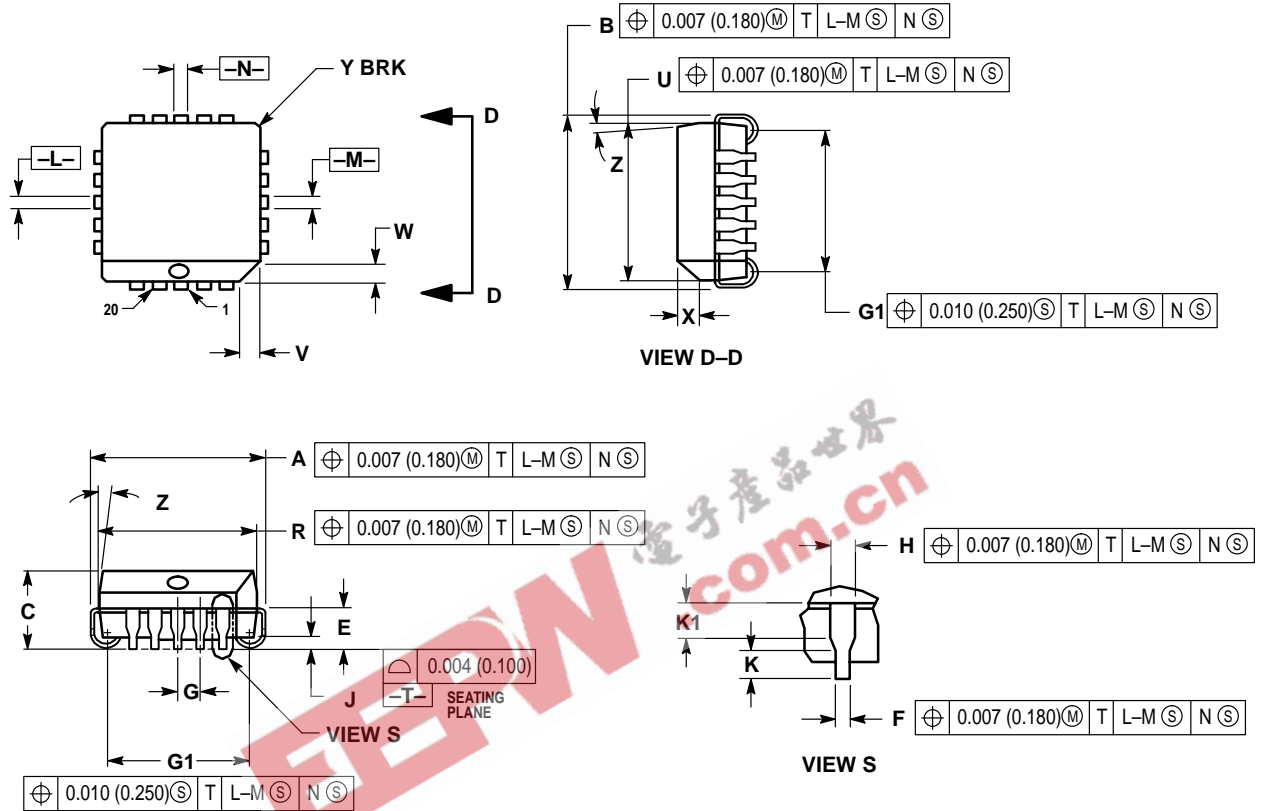

NOTES:

- DATUMS -L-, -M-, AND -N- DETERMINED WHERE TOP OF LEAD SHOULDER EXITS PLASTIC BODY AT MOLD PARTING LINE.
- DIMENSION G1, TRUE POSITION TO BE MEASURED AT DATUM -T-, SEATING PLANE.
- DIMENSIONS R AND U DO NOT INCLUDE MOLD FLASH. ALLOWABLE MOLD FLASH IS 0.010 (0.250) PER SIDE.
- DIMENSIONING AND TOLERANCING PER ANSI Y14.5M, 1982.
- CONTROLLING DIMENSION: INCH.
- THE PACKAGE TOP MAY BE SMALLER THAN THE PACKAGE BOTTOM BY UP TO 0.012 (0.300). DIMENSIONS R AND U ARE DETERMINED AT THE OUTERMOST EXTREMES OF THE PLASTIC BODY EXCLUSIVE OF MOLD FLASH, TIE BAR BURRS, GATE BURRS AND INTERLEAD FLASH, BUT INCLUDING ANY MISMATCH BETWEEN THE TOP AND BOTTOM OF THE PLASTIC BODY.
- DIMENSION H DOES NOT INCLUDE DAMBAR PROTRUSION OR INTRUSION. THE DAMBAR PROTRUSION(S) SHALL NOT CAUSE THE H DIMENSION TO BE GREATER THAN 0.037 (0.940). THE DAMBAR INTRUSION(S) SHALL NOT CAUSE THE H DIMENSION TO BE SMALLER THAN 0.025 (0.635).

DIM	INCHES		MILLIMETERS	
	MIN	MAX	MIN	MAX
A	0.385	0.395	9.78	10.03
B	0.385	0.395	9.78	10.03
C	0.165	0.180	4.20	4.57
E	0.090	0.110	2.29	2.79
F	0.013	0.019	0.33	0.48
G	0.050 BSC		1.27 BSC	
H	0.026	0.032	0.66	0.81
J	0.020	—	0.51	—
K	0.025	—	0.64	—
R	0.350	0.356	8.89	9.04
U	0.350	0.356	8.89	9.04
V	0.042	0.048	1.07	1.21
W	0.042	0.048	1.07	1.21
X	0.042	0.056	1.07	1.42
Y	—	0.020	—	0.50
Z	2°	10°	2°	10°
G1	0.310	0.330	7.88	8.38
K1	0.040	—	1.02	—

AM26LS30

EEPW 电子產品世界 .com.cn

Motorola reserves the right to make changes without further notice to any products herein. Motorola makes no warranty, representation or guarantee regarding the suitability of its products for any particular purpose, nor does Motorola assume any liability arising out of the application or use of any product or circuit, and specifically disclaims any and all liability, including without limitation consequential or incidental damages. "Typical" parameters can and do vary in different applications. All operating parameters, including "Typicals" must be validated for each customer application by customer's technical experts. Motorola does not convey any license under its patent rights nor the rights of others. Motorola products are not designed, intended, or authorized for use as components in systems intended for surgical implant into the body, or other applications intended to support or sustain life, or for any other application in which the failure of the Motorola product could create a situation where personal injury or death may occur. Should Buyer purchase or use Motorola products for any such unintended or unauthorized application, Buyer shall indemnify and hold Motorola and its officers, employees, subsidiaries, affiliates, and distributors harmless against all claims, costs, damages, and expenses, and reasonable attorney fees arising out of, directly or indirectly, any claim of personal injury or death associated with such unintended or unauthorized use, even if such claim alleges that Motorola was negligent regarding the design or manufacture of the part. Motorola and  are registered trademarks of Motorola, Inc. Motorola, Inc. is an Equal Opportunity/Affirmative Action Employer.

How to reach us:

USA / EUROPE: Motorola Literature Distribution;
P.O. Box 20912; Phoenix, Arizona 85036. 1-800-441-2447

JAPAN: Nippon Motorola Ltd.; Tatsumi-SPD-JLDC, Toshikatsu Otsuki,
6F Seibu-Butsuryu-Center, 3-14-2 Tatsumi Koto-Ku, Tokyo 135, Japan. 03-3521-8315

MFAX: RMFAX0@email.sps.mot.com – TOUCHTONE (602) 244-6609
INTERNET: <http://Design-NET.com>

HONG KONG: Motorola Semiconductors H.K. Ltd.; 8B Tai Ping Industrial Park,
51 Ting Kok Road, Tai Po, N.T., Hong Kong. 852-26629298



AM26LS30/D

