

# AZ764

## 16 A SPDT MINIATURE POWER RELAY

### FEATURES

- Dielectric strength 5000 Vrms
- Low height: 15.7 mm
- Epoxy sealed version available
- 16 Amp switching (High inrush version 80A available)
- AC and DC coils
- Isolation spacing greater than 10 mm
- Proof tracking index (PTI/CTI) 250
- Reinforced insulation, EN 60730-1 (VDE 0631, part 1) EN 60335-1 (VDE 0700, part 1)
- UL, CUR file E43203
- VDE file 40012572

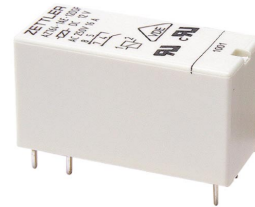

### CONTACTS

<b>Arrangement</b>	SPDT (1 Form C) SPST (1 Form A)
<b>Ratings</b>	Resistive load: Max. switched power: 480 W or 4000 VA Max. switched current: 16 A Max. switched voltage: 300 VDC* or 400 VAC * Note: If switching voltage is greater than 30 VDC, special precautions must be taken. Please contact the factory.
<b>Rated Load</b>	
<b>UL, CUR</b>	16 A at 250 VAC General Use
<b>VDE</b>	16 A at 250 VAC
<b>Material</b>	Silver cadmium oxide, silver nickel or silver tin oxide
<b>Resistance</b>	< 100 milliohms initially

### COIL

<b>Power</b>	
<b>At Pickup Voltage (typical)</b>	200 mW (DC coil) .422 VA (AC coil)
<b>Max. Continuous Dissipation</b>	1.7 W at 20°C (68°F) ambient 1.7 VA at 20°C (68°F) ambient
<b>Temperature Rise</b>	26°C (47°F) at nominal coil voltage
<b>Max. Temperature</b>	155°C (311°F)

### NOTES

1. All values at 20°C (68°F).
2. Relay may pull in with less than "Must Operate" value.
3. Specifications subject to change without notice.

### GENERAL DATA

<b>Life Expectancy</b> <b>Mechanical</b> <b>Electrical</b>	Minimum operations 3 x 10 <sup>7</sup> 7 x 10 <sup>4</sup> at 16 A 250 VAC res.
<b>Operate Time (typical)</b>	7 ms at nominal coil voltage
<b>Release Time (typical)</b>	3 ms at nominal coil voltage (with no coil suppression)
<b>Dielectric Strength</b> (at sea level for 1 min.)	5000 Vrms coil to contact 2500 Vrms between contact sets 1000 Vrms between open contacts
<b>Insulation Resistance</b>	10 <sup>5</sup> megohms min. at 500 VDC, 20°C, 50% RH
<b>Insulation (according to DIN VDE 0110, IEC 60664-1)</b>	B250 at 1 Form C, flux proof version C250 at other relay versions Overvoltage category: III Pollution degree: 3 Nominal voltage: 250 VAC
<b>Dropout DC coils</b> <b>AC coils</b>	Greater than 10% of nominal coil voltage Greater than 15% of nominal coil voltage
<b>Ambient Temperature Operating</b> <b>Storage</b>	At nominal coil voltage -40°C (-40°F) to 85°C (185°F) - DC coils -40°C (-40°F) to 70°C (158°F) - AC coils -40°C (-40°F) to 105°C (221°F)
<b>Vibration</b>	Break contacts: 5 g at 20...500 Hz Make contacts: 20 g at 30...500 Hz
<b>Shock</b>	20 g
<b>Enclosure</b>	P.B.T. polyester, UL-94 : V0
<b>Terminals</b>	Tinned copper alloy, P.C.
<b>Max. Solder Temp.</b>	270°C (518°F)
<b>Max. Solder Time</b>	5 seconds
<b>Max. Solvent Temp.</b>	80°C (176°F)
<b>Max. Immersion Time</b>	30 seconds
<b>Weight</b>	14 grams
<b>Packing unit in pcs</b>	20 per carton tube / 1000 per carton box

## ZETTLER electronics GmbH

Junkersstrasse 3, D-82178 Puchheim, Germany

Tel. +49 89 800 97 0  
Fax +49 89 800 97 200

office@ZETTLERelectronics.com  
www.ZETTLERelectronics.com

# AZ764

## RELAY ORDERING DATA

COIL SPECIFICATIONS - DC COIL				ORDER NUMBER*	
Nominal Coil VDC	Must Operate VDC	Max. Continuous VDC	Coil Resistance Ohm $\pm 10\%$	1 Form A	1 Form C
3	2.1	7.6	22	AZ764-1AH-3D	AZ764-1CH-3D
5	3.5	12.7	60	AZ764-1AH-5D	AZ764-1CH-5D
6	4.2	15.3	90	AZ764-1AH-6D	AZ764-1CH-6D
9	6.3	22.9	200	AZ764-1AH-9D	AZ764-1CH-9D
12	8.4	30.6	360	AZ764-1AH-12D	AZ764-1CH-12D
18	12.6	45.9	710	AZ764-1AH-18D	AZ764-1CH-18D
24	16.8	61.2	1,440	AZ764-1AH-24D	AZ764-1CH-24D
36	25.2	92.0	3,140	AZ764-1AH-36D	AZ764-1CH-36D
48	33.6	122.0	5,700	AZ764-1AH-48D	AZ764-1CH-48D
60	42.0	153.0	7,500	AZ764-1AH-60D	AZ764-1CH-60D
110	77.0	280.0	25,200	AZ764-1AH-110D	AZ764-1CH-110D

COIL SPECIFICATIONS - AC COIL					ORDER NUMBER*	
Nominal Coil VAC	Must Operate VAC	Max. Continuous VAC	Nominal Current mA $\pm 10\%$	Coil Resistance Ohm $\pm 10\%$	1 Form A	1 Form C
12	9.0	18.0	63.0	100	AZ764-1AH-12A	AZ764-1CH-12A
24	18.0	36.0	31.3	400	AZ764-1AH-24A	AZ764-1CH-24A
48	36.0	72.0	15.6	1,550	AZ764-1AH-48A	AZ764-1CH-48A
60	45.0	90.0	12.5	2,600	AZ764-1AH-60A	AZ764-1CH-60A
110	82.5	165.0	6.8	8,900	AZ764-1AH-110A	AZ764-1CH-110A
115	86.3	172.5	6.5	9,600	AZ764-1AH-115A	AZ764-1CH-115A
120	90.0	180.0	6.3	10,200	AZ764-1AH-120A	AZ764-1CH-120A
220	165.0	330.0	3.4	35,500	AZ764-1AH-220A	AZ764-1CH-220A
230	172.5	345.0	3.3	38,500	AZ764-1AH-230A	AZ764-1CH-230A
240	180.0	360.0	3.1	42,500	AZ764-1AH-240A	AZ764-1CH-240A

\* "1AH" or "1CH" denote silver cadmium oxide contacts.  
 Substitute "E" for "H" at "1AH" or "1CH" for silver tin oxide contacts.  
 Remove the "H" at "1AH" or "1CH" for silver nickel contacts.  
 Add suffix "E" at the end of order number for sealed version.

Substitute "1AT" for "1AH" for high inrush 80A silver tin oxide contacts (available on 1 Form A and DC coils only).

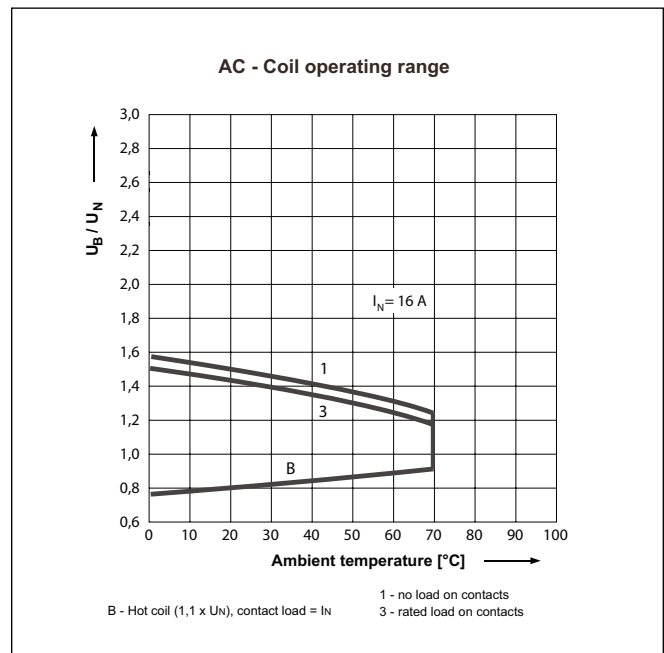
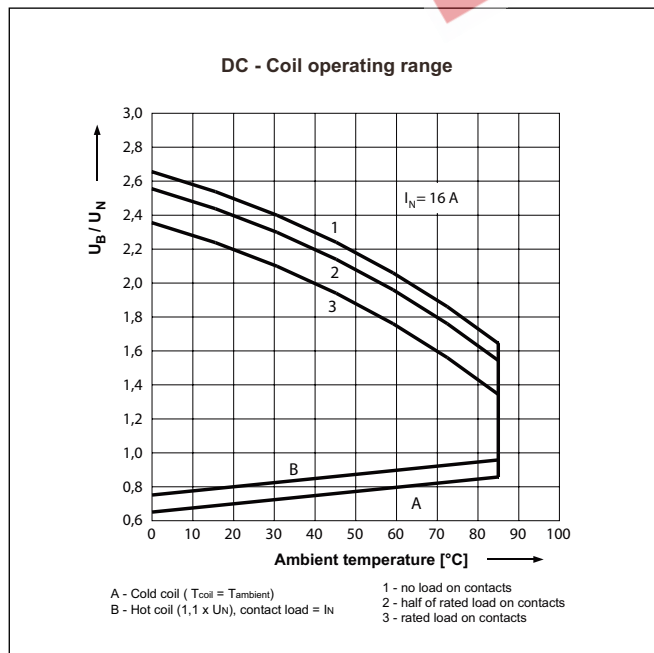

**ZETTLER electronics GmbH**

Junkersstrasse 3, D-82178 Puchheim, Germany

Tel. +49 89 800 97 0  
 Fax +49 89 800 97 200

office@ZETTLERelectronics.com  
 www.ZETTLERelectronics.com

# AZ764

## MECHANICAL DATA

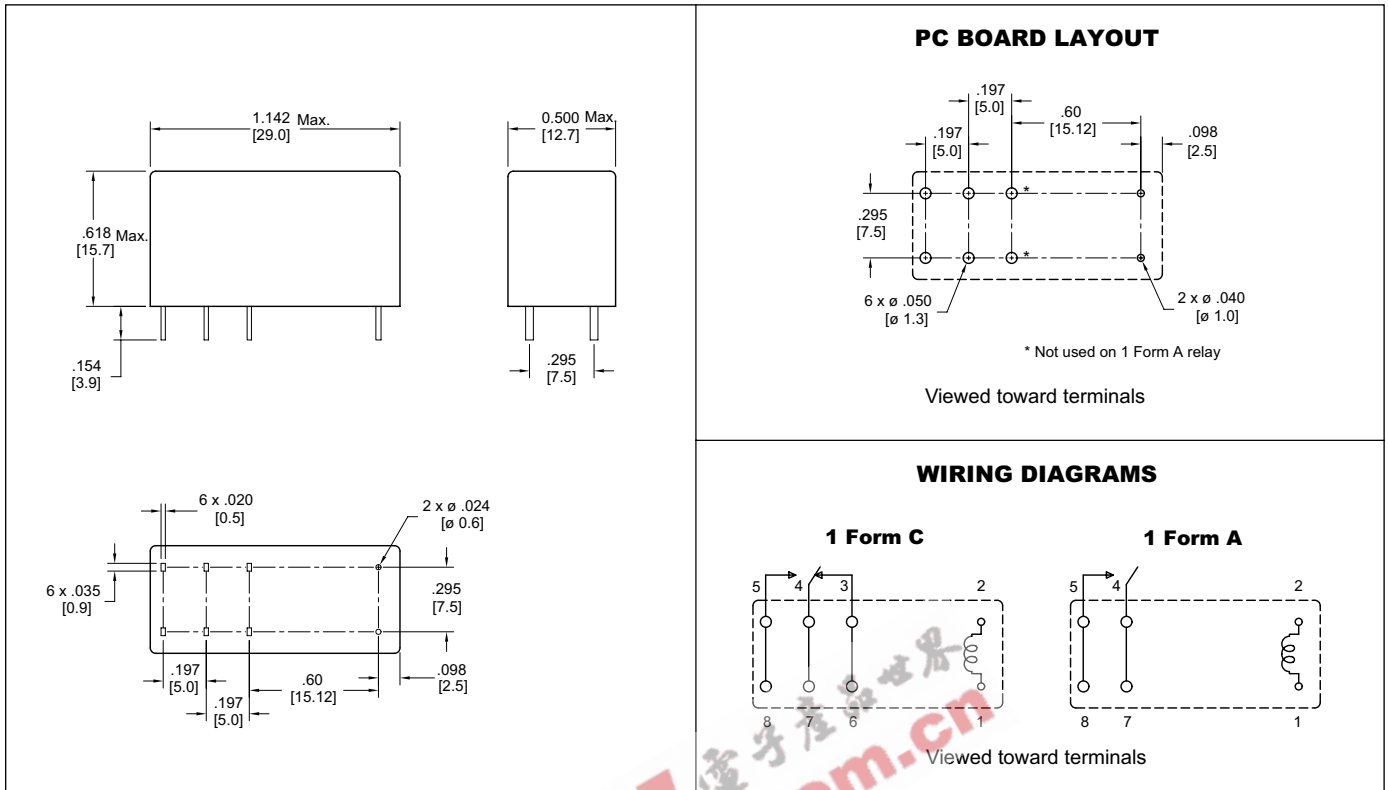

Dimensions in inches with metric equivalents in parentheses. Tolerance:  $\pm .010''$

## ACCESSORIES

For P.C.B. mount: Socket EC 50  
Retaining Clip MP 16 / MH 16

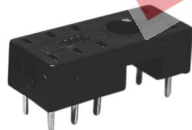

For DIN rail mount: Socket ES 50  
Retaining Clip MS 16

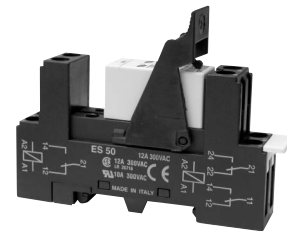

## MECHANICAL DATA

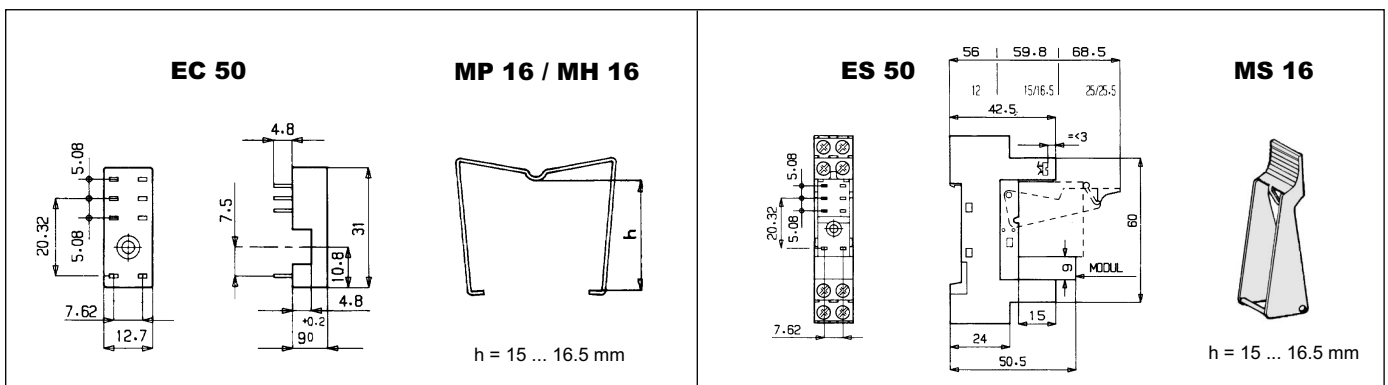

**ZETTLER electronics GmbH**

Junkersstrasse 3, D-82178 Puchheim, Germany

Tel. +49 89 800 97 0  
Fax +49 89 800 97 200

office@ZETTLERelectronics.com  
www.ZETTLERelectronics.com

2005-08-04

Electrical life at 250 VAC, resistive load

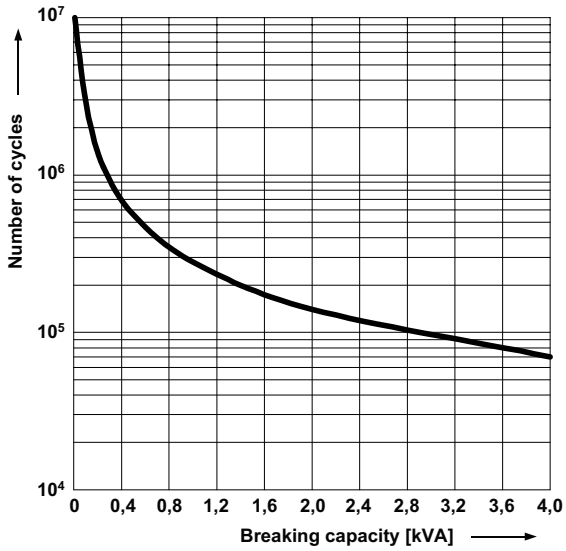

Electrical life reduction factor at inductive AC load

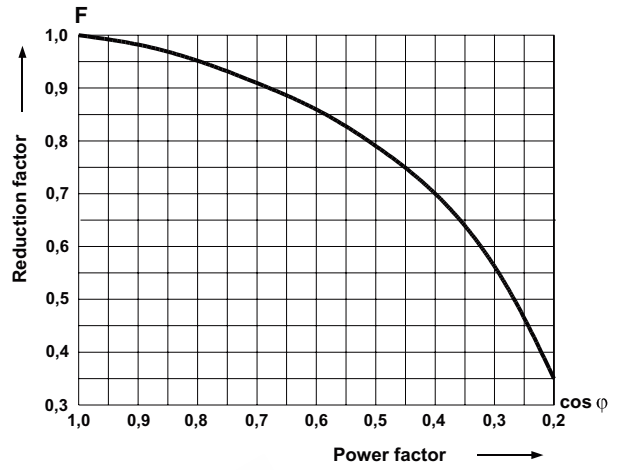

$$N_{\cos \varphi} = N \times F$$

Max. DC resistive load breaking capacity

