

**1A ULTRA LOW DROPOUT LINEAR REGULATOR****AZ2940****General Description**

The AZ2940 is a low dropout three-terminal regulator with a typical dropout of 280mV at 1A output current.

The AZ2940 provides current limit and thermal shutdown. On-chip thermal shutdown provides protection against any combination of high current and ambient temperature that would create excessive junction temperatures.

The AZ2940 has 2.5V, 3.3V and 5.0V versions.

The AZ2940 is available in the industry standard TO-220-3, TO-263-3 and TO-252-2 power packages.

**Features**

- Minimum Guaranteed Output Current: 1A
- Dropout Voltage at  $I_{OUT}=1A$ : 280mV
- Output Accuracy:  $\pm 1\%$
- Low Ground Current
- Internal Current Limit and Thermal Protection
- Reversed-battery and Reversed-lead Insertion Protection
- Fast Transient Response

**Applications**

- LCD TV
- Set Top Box
- LCD Monitor
- SMPS Post Regulator
- Laptop, Palmtop and Notebook
- Portable Instrumentation
- USB Power Supply

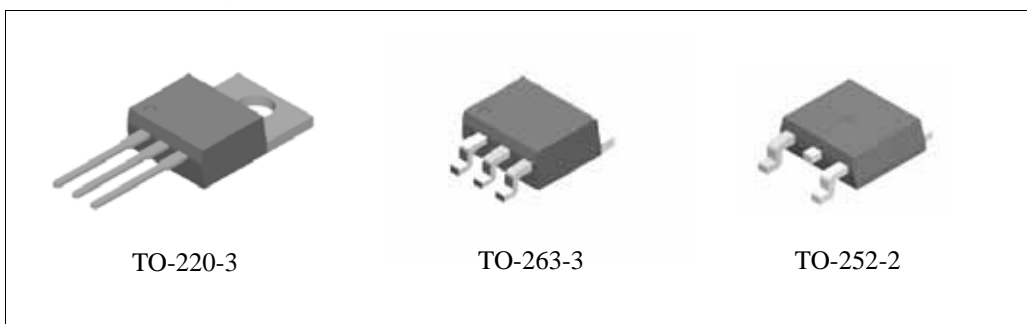

Figure 1. Package Types of AZ2940

**1A ULTRA LOW DROPOUT LINEAR REGULATOR****AZ2940****Pin Configuration**

Figure 2. Pin Configuration of AZ2940 (Top View)

**Pin Description**

Pin Number	Pin Name	Function
1	$V_{IN}$	Unregulated Input.
2	GND	Ground pin. This pin and TAB are internally connected.
3	$V_{OUT}$	Regulated Output.

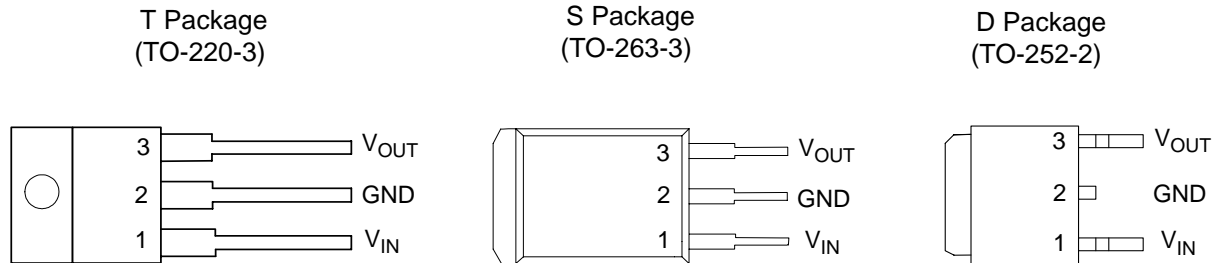

**1A ULTRA LOW DROPOUT LINEAR REGULATOR**

**AZ2940**

**Functional Block Diagram**

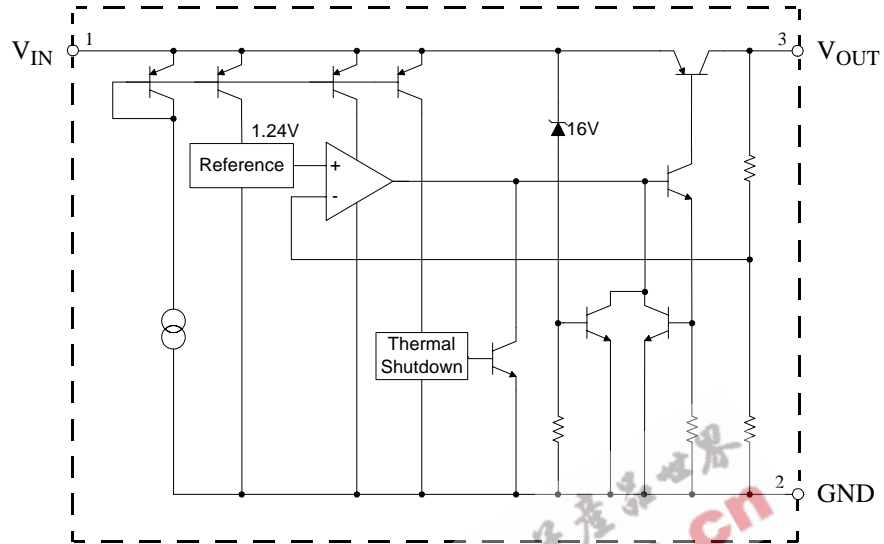
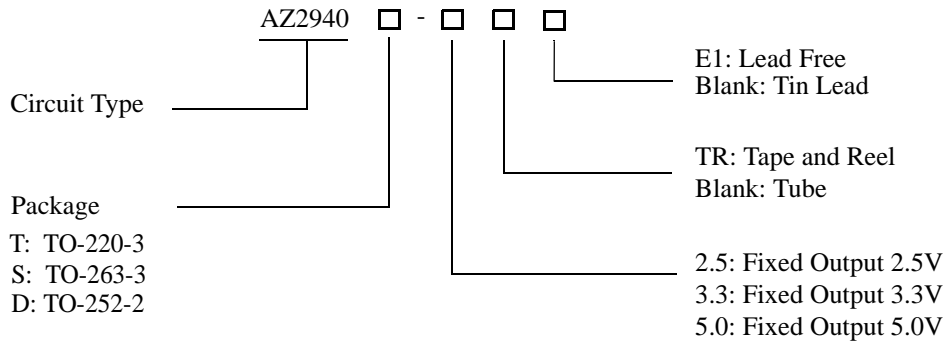

Figure 3. Functional Block Diagram of AZ2940



**1A ULTRA LOW DROPOUT LINEAR REGULATOR** **AZ2940**

**Ordering Information**



Package	Temperature Range	Part Number		Marking ID		Packing Type
		Tin Lead	Lead Free	Tin Lead	Lead Free	
TO-220-3	-40 to 125°C	AZ2940T-2.5	AZ2940T-2.5E1	AZ2940T-2.5	AZ2940T-2.5E1	Tube
		AZ2940T-3.3	AZ2940T-3.3E1	AZ2940T-3.3	AZ2940T-3.3E1	Tube
		AZ2940T-5.0	AZ2940T-5.0E1	AZ2940T-5.0	AZ2940T-5.0E1	Tube
TO-263-3	-40 to 125°C	AZ2940S-2.5	AZ2940S-2.5E1	AZ2940S-2.5	AZ2940S-2.5E1	Tube
		AZ2940S-2.5TR	AZ2940S-2.5TRE1	AZ2940S-2.5	AZ2940S-2.5E1	Tape & Reel
		AZ2940S-3.3	AZ2940S-3.3E1	AZ2940S-3.3	AZ2940S-3.3E1	Tube
		AZ2940S-3.3TR	AZ2940S-3.3TRE1	AZ2940S-3.3	AZ2940S-3.3E1	Tape & Reel
		AZ2940S-5.0	AZ2940S-5.0E1	AZ2940S-5.0	AZ2940S-5.0E1	Tube
		AZ2940S-5.0TR	AZ2940S-5.0TRE1	AZ2940S-5.0	AZ2940S-5.0E1	Tape & Reel
TO-252-2	-40 to 125°C	AZ2940D-2.5	AZ2940D-2.5E1	AZ2940D-2.5	AZ2940D-2.5E1	Tube
		AZ2940D-2.5TR	AZ2940D-2.5TRE1	AZ2940D-2.5	AZ2940D-2.5E1	Tape & Reel
		AZ2940D-3.3	AZ2940D-3.3E1	AZ2940D-3.3	AZ2940D-3.3E1	Tube
		AZ2940D-3.3TR	AZ2940D-3.3TRE1	AZ2940D-3.3	AZ2940D-3.3E1	Tape & Reel
		AZ2940D-5.0	AZ2940D-5.0E1	AZ2940D-5.0	AZ2940D-5.0E1	Tube
		AZ2940D-5.0TR	AZ2940D-5.0TRE1	AZ2940D-5.0	AZ2940D-5.0E1	Tape & Reel

BCD Semiconductor's Pb-free products, as designated with "E1" suffix in the part number, are RoHS compliant.

**1A ULTRA LOW DROPOUT LINEAR REGULATOR****AZ2940****Absolute Maximum Ratings (Note 1)**

Parameter	Symbol	Value	Unit
Supply Voltage	$V_{IN}$	16	V
Maximum Operating Junction Temperature	$T_J$	150	°C
Storage Temperature Range	$T_{STG}$	-65 to 150	°C
Lead Temperature (Soldering, 10sec)	$T_{LEAD}$	300	°C
ESD (Machine Model)		300	V

Note 1: Stresses greater than those listed under "Absolute Maximum Ratings" may cause permanent damage to the device. These are stress ratings only, and functional operation of the device at these or any other conditions beyond those indicated under "Recommended Operating Conditions" is not implied. Exposure to "Absolute Maximum Ratings" for extended periods may affect device reliability.

**Recommended Operating Conditions**

Parameter	Symbol	Min	Max	Unit
Supply Voltage	$V_{IN}$		13.2	V
Operating Junction Temperature	$T_J$	-40	125	°C



**1A ULTRA LOW DROPOUT LINEAR REGULATOR AZ2940**

**Electrical Characteristics**

**AZ2940-2.5V Electrical Characteristics**

Operating Conditions:  $V_{IN}=3.5V$ ,  $I_{OUT}=10mA$ ,  $C_{IN}=10\mu F$ ,  $C_{OUT}=10\mu F$ ,  $T_J=25^\circ C$ , unless otherwise specified. The **Boldface** applies over  $-40^\circ C \leq T_J \leq 125^\circ C$ .

Parameter	Symbol	Condition	Min	Typ	Max	Unit
Output Voltage	$V_{OUT}$	$I_{OUT}=10mA$	2.475	2.5	2.525	V
		$10mA \leq I_{OUT} \leq 1A$ , $3.5V \leq V_{IN} \leq 13.2V$	<b>2.45</b>	<b>2.5</b>	<b>2.55</b>	V
Line Regulation	$V_{RLINE}$	$I_{OUT}=10mA$ , $3.5V \leq V_{IN} \leq 13.2V$		5.0	25	mV
Load Regulation	$V_{RLOAD}$	$V_{IN}=3.5V$ , $10mA \leq I_{OUT} \leq 1A$		7.5	37.5	mV
Output Voltage Temperature Coefficient	$\Delta V_{OUT}/\Delta T$	$I_{OUT}=10mA$		<b>50</b>	<b>250</b>	$\mu V/^\circ C$
Dropout Voltage (Note 2)	$V_{DROP}$	$\Delta V_{OUT}=1\%$	$I_{OUT}=100mA$	70	<b>200</b>	mV
			$I_{OUT}=1A$	280	<b>550</b>	mV
Ground Current	$I_{GND}$	$V_{IN}=3.5V$	$I_{OUT}=750mA$	12	<b>25</b>	mA
			$I_{OUT}=1A$	18		mA
Current Limit	$I_{LIMIT}$	$V_{OUT}=0V$ (Note 3)	1.5	2.2		A
Minimum Load Current	$I_{LOAD (MIN)}$			1	5	mA
Output Noise Voltage (rms)		10Hz to 100KHz, $I_{OUT}=100mA$ , $C_{OUT}=10\mu F$		400		$\mu V$

Note 2: Dropout voltage is defined as the input-to-output differential when the output voltage drops to 99% of its nominal value which is measured at  $V_{OUT}+1V$  applied to  $V_{IN}$ .

Note 3:  $V_{IN}=V_{OUT(NOMINAL)}+1V$ .



**1A ULTRA LOW DROPOUT LINEAR REGULATOR**

**AZ2940**

**Electrical Characteristics (Continued)**

**AZ2940-3.3V Electrical Characteristics**

Operating Conditions:  $V_{IN}=4.3V$ ,  $I_{OUT}=10mA$ ,  $C_{IN}=10\mu F$ ,  $C_{OUT}=10\mu F$ ,  $T_J=25^\circ C$ , unless otherwise specified. The **Boldface** applies over  $-40^\circ C \leq T_J \leq 125^\circ C$ .

Parameter	Symbol	Condition	Min	Typ	Max	Unit
Output Voltage	$V_{OUT}$	$I_{OUT}=10mA$	3.27	3.3	3.33	V
		$10mA \leq I_{OUT} \leq 1A$ , $4.3V \leq V_{IN} \leq 13.2V$	<b>3.23</b>	<b>3.3</b>	<b>3.37</b>	V
Line Regulation	$V_{RLINE}$	$I_{OUT}=10mA$ , $4.3V \leq V_{IN} \leq 13.2V$		6.6	33	mV
Load Regulation	$V_{RLOAD}$	$V_{IN}=4.3V$ , $10mA \leq I_{OUT} \leq 1A$		9.9	50	mV
Output Voltage Temperature Coefficient	$\Delta V_{OUT}/\Delta T$	$I_{OUT}=10mA$		<b>66</b>	<b>330</b>	$\mu V/^\circ C$
Dropout Voltage (Note 2)	$V_{DROP}$	$\Delta V_{OUT}=1\%$	$I_{OUT}=100mA$	70	<b>200</b>	mV
			$I_{OUT}=1A$	280	<b>550</b>	mV
Ground Current	$I_{GND}$	$V_{IN}=4.3V$	$I_{OUT}=750mA$	12	<b>25</b>	mA
			$I_{OUT}=1A$	18		mA
Current Limit	$I_{LIMIT}$	$V_{OUT}=0V$ (Note 3)	1.5	2.2		A
Minimum Load Current	$I_{LOAD(MIN)}$			1	5	mA
Output Noise Voltage (rms)		10Hz to 100KHz, $I_{OUT}=100mA$ , $C_{OUT}=10\mu F$		400		$\mu V$

Note 2: Dropout voltage is defined as the input-to-output differential when the output voltage drops to 99% of its nominal value which is measured at  $V_{OUT}+1V$  applied to  $V_{IN}$ .

Note 3:  $V_{IN}=V_{OUT(NOMINAL)}+1V$ .



**1A ULTRA LOW DROPOUT LINEAR REGULATOR**

**AZ2940**

**Electrical Characteristics (Continued)**

**AZ2940-5.0V Electrical Characteristics**

Operating Conditions:  $V_{IN}=6V$ ,  $I_{OUT}=10mA$ ,  $C_{IN}=10\mu F$ ,  $C_{OUT}=10\mu F$ ,  $T_J=25^\circ C$ , unless otherwise specified. The **Boldface** applies over  $-40^\circ C \leq T_J \leq 125^\circ C$ .

Parameter	Symbol	Condition	Min	Typ	Max	Unit
Output Voltage	$V_{OUT}$	$I_{OUT}=10mA$	4.95	5.0	5.05	V
		$10mA \leq I_{OUT} \leq 1A$ , $6V \leq V_{IN} \leq 13.2V$	<b>4.90</b>	<b>5.0</b>	<b>5.10</b>	V
Line Regulation	$V_{RLINE}$	$I_{OUT}=10mA$ , $6V \leq V_{IN} \leq 13.2V$		10	50	mV
Load Regulation	$V_{RLOAD}$	$V_{IN}=6V$ , $10mA \leq I_{OUT} \leq 1A$		15	75	mV
Output Voltage Temperature Coefficient	$\Delta V_{OUT}/\Delta T$	$I_{OUT}=10mA$		<b>100</b>	<b>500</b>	$\mu V/^\circ C$
Dropout Voltage (Note 2)	$V_{DROP}$	$\Delta V_{OUT}=1\%$	$I_{OUT}=100mA$	70	<b>200</b>	mV
			$I_{OUT}=1A$	280	<b>550</b>	mV
Ground Current	$I_{GND}$	$V_{IN}=6V$	$I_{OUT}=750mA$	12	<b>25</b>	mA
			$I_{OUT}=1A$	18		mA
Current Limit	$I_{LIMIT}$	$V_{OUT}=0V$ (Note 3)	1.5	2.2		A
Minimum Load Current	$I_{LOAD(MIN)}$			1	5	mA
Output Noise Voltage (rms)		10Hz to 100KHz, $I_{OUT}=100mA$ , $C_{OUT}=10\mu F$		400		$\mu V$

Note 2: Dropout voltage is defined as the input-to-output differential when the output voltage drops to 99% of its nominal value which is measured at  $V_{OUT}+1V$  applied to  $V_{IN}$ .

Note 3:  $V_{IN}=V_{OUT(NOMINAL)}+1V$ .





**1A ULTRA LOW DROPOUT LINEAR REGULATOR**

**AZ2940**

**Typical Performance Characteristics**

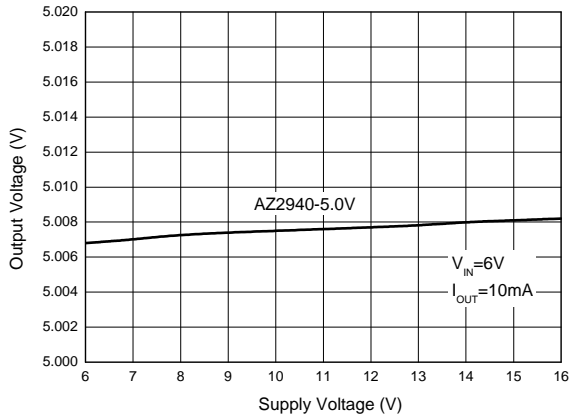

Figure 4. Line Regulation

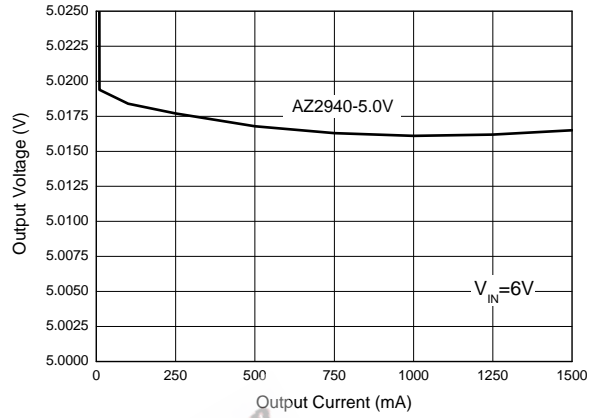

Figure 5. Load Regulation

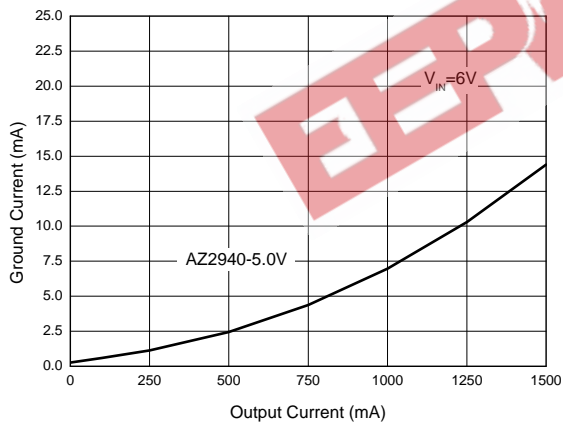

Figure 6. Ground Current vs. Output Current

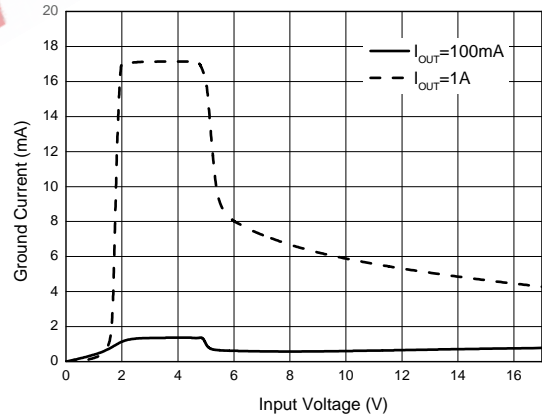

Figure 7. Ground Current vs. Input Voltage



**1A ULTRA LOW DROPOUT LINEAR REGULATOR**

**AZ2940**

**Typical Performance Characteristics (Continued)**

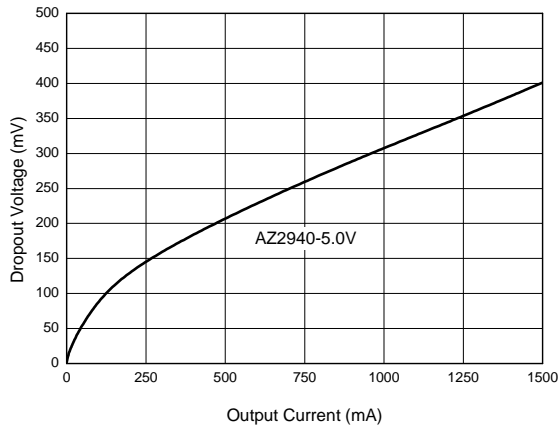

Figure 8. Dropout Voltage vs. Output Current

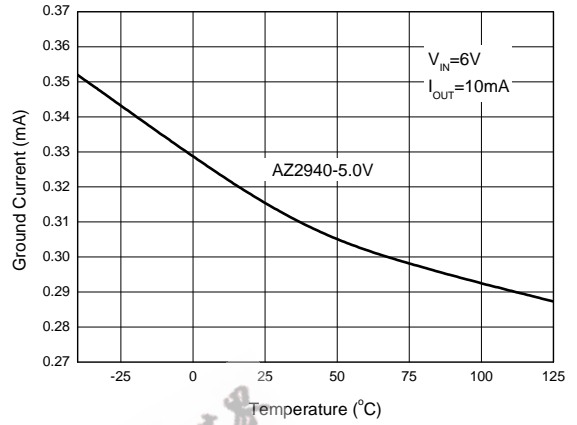

Figure 9. Ground Current vs. Temperature

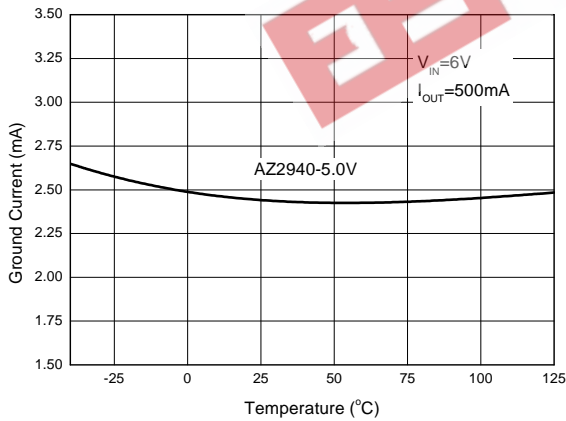

Figure 10. Ground Current vs. Temperature

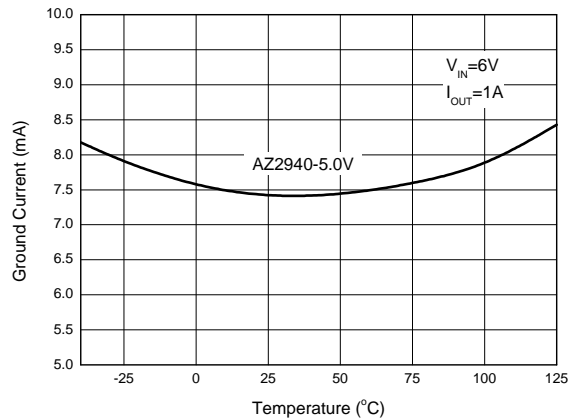

Figure 11. Ground Current vs. Temperature



**1A ULTRA LOW DROPOUT LINEAR REGULATOR**

**AZ2940**

**Typical Performance Characteristics (Continued)**

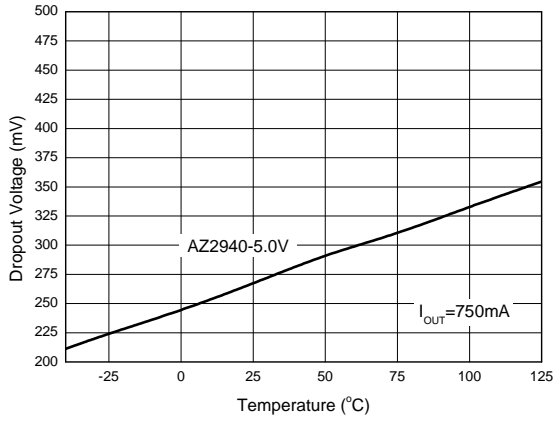

Figure 12. Dropout Voltage vs. Temperature

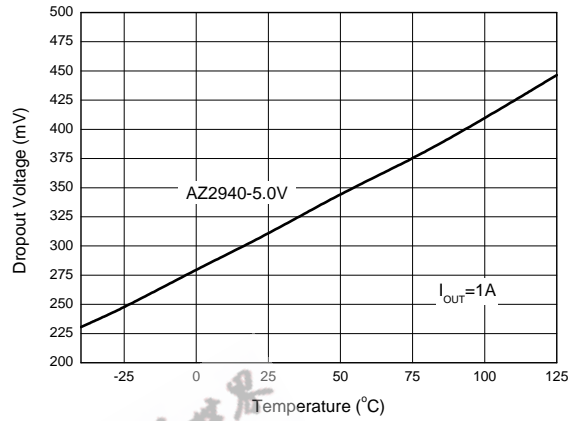

Figure 13. Dropout Voltage vs. Temperature

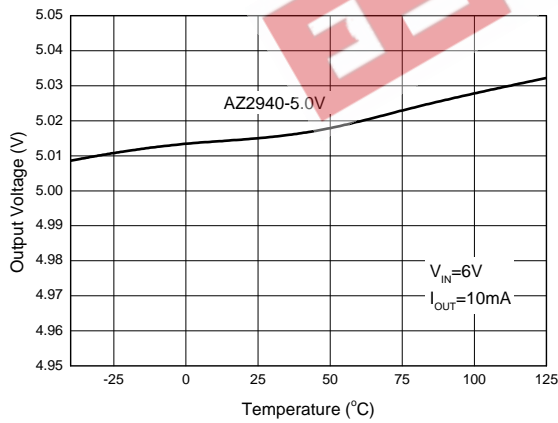

Figure 14. Output Voltage vs. Temperature

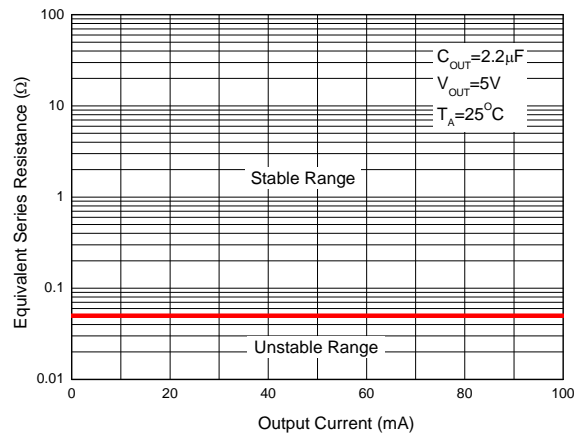

Figure 15. Output Capacitor ESR



**1A ULTRA LOW DROPOUT LINEAR REGULATOR**

**AZ2940**

**Typical Performance Characteristics (Continued)**

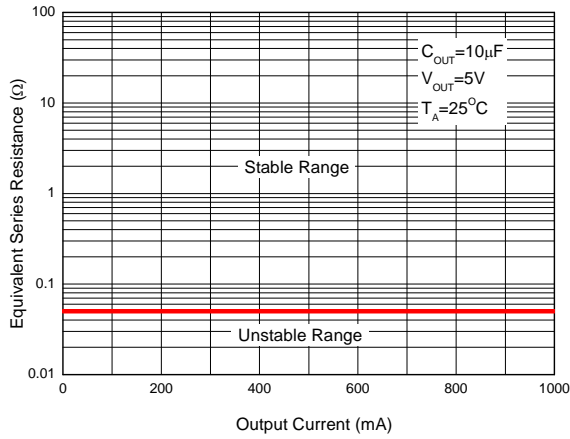

Figure 16. Output Capacitor ESR

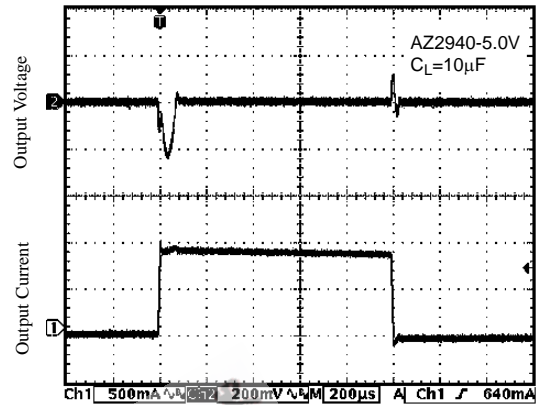

Figure 17. Load Transient

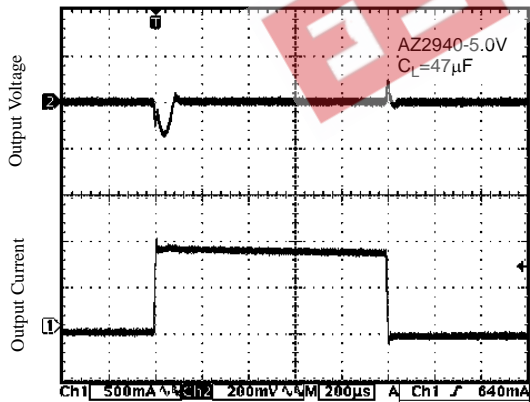

Figure 18. Load Transient

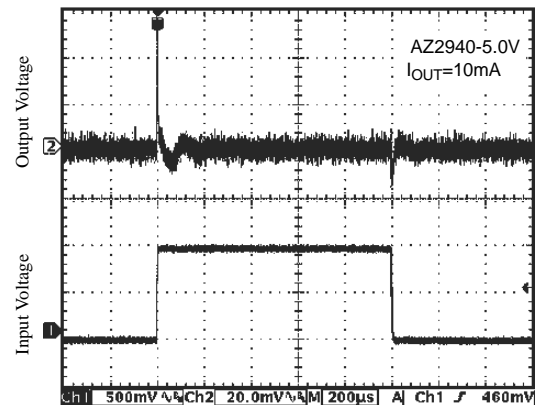

Figure 19. Line Transient



1A ULTRA LOW DROPOUT LINEAR REGULATOR

AZ2940

Typical Performance Characteristics (Continued)

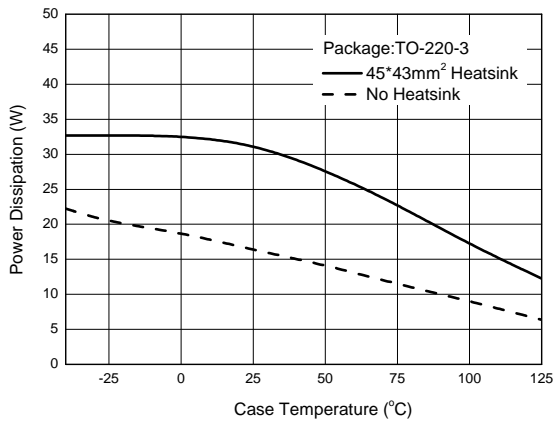

Figure 20. Power Dissipation vs. Case Temperature

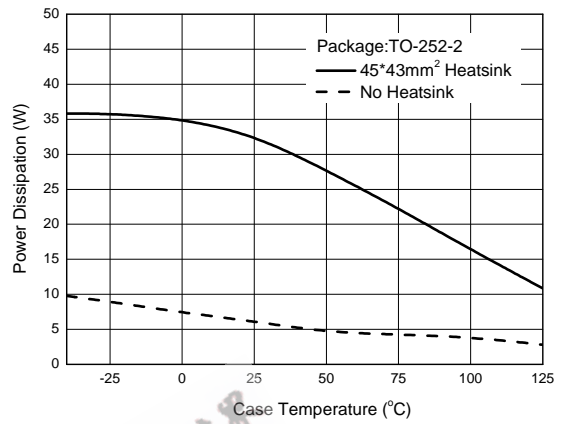

Figure 21. Power Dissipation vs. Case Temperature

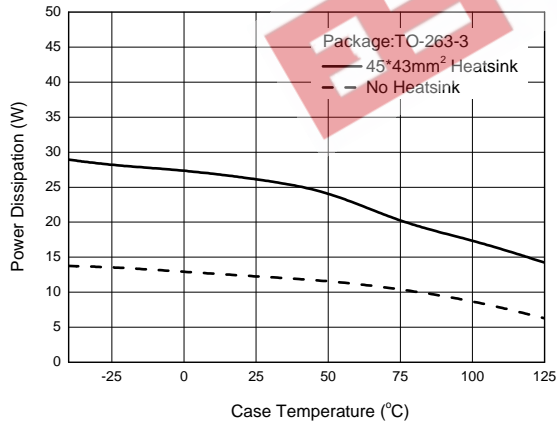

Figure 22. Power Dissipation vs. Case Temperature



**1A ULTRA LOW DROPOUT LINEAR REGULATOR**

**AZ2940**

**Typical Application**

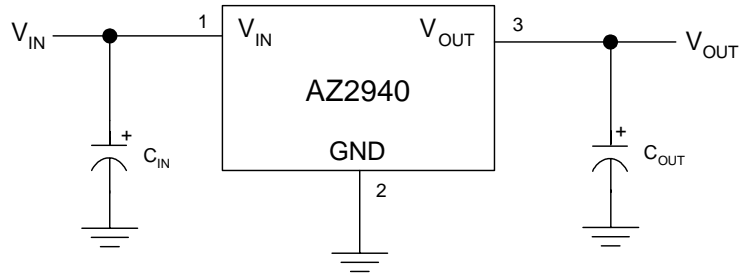

Figure 23. Typical Application of AZ2940

Note:  $C_{IN}$  is required if regulator is located far from power supply filter and is recommended to be  $0.47\mu\text{F}$  or greater. To maintain stability,  $C_{OUT}$  is recommended to be  $2.2\mu\text{F}$  or greater. The ESR of this capacitor is critical, please see curve.



**1A ULTRA LOW DROPOUT LINEAR REGULATOR**

**AZ2940**

**Mechanical Dimensions**

**TO-220-3**

**Unit: mm(inch)**

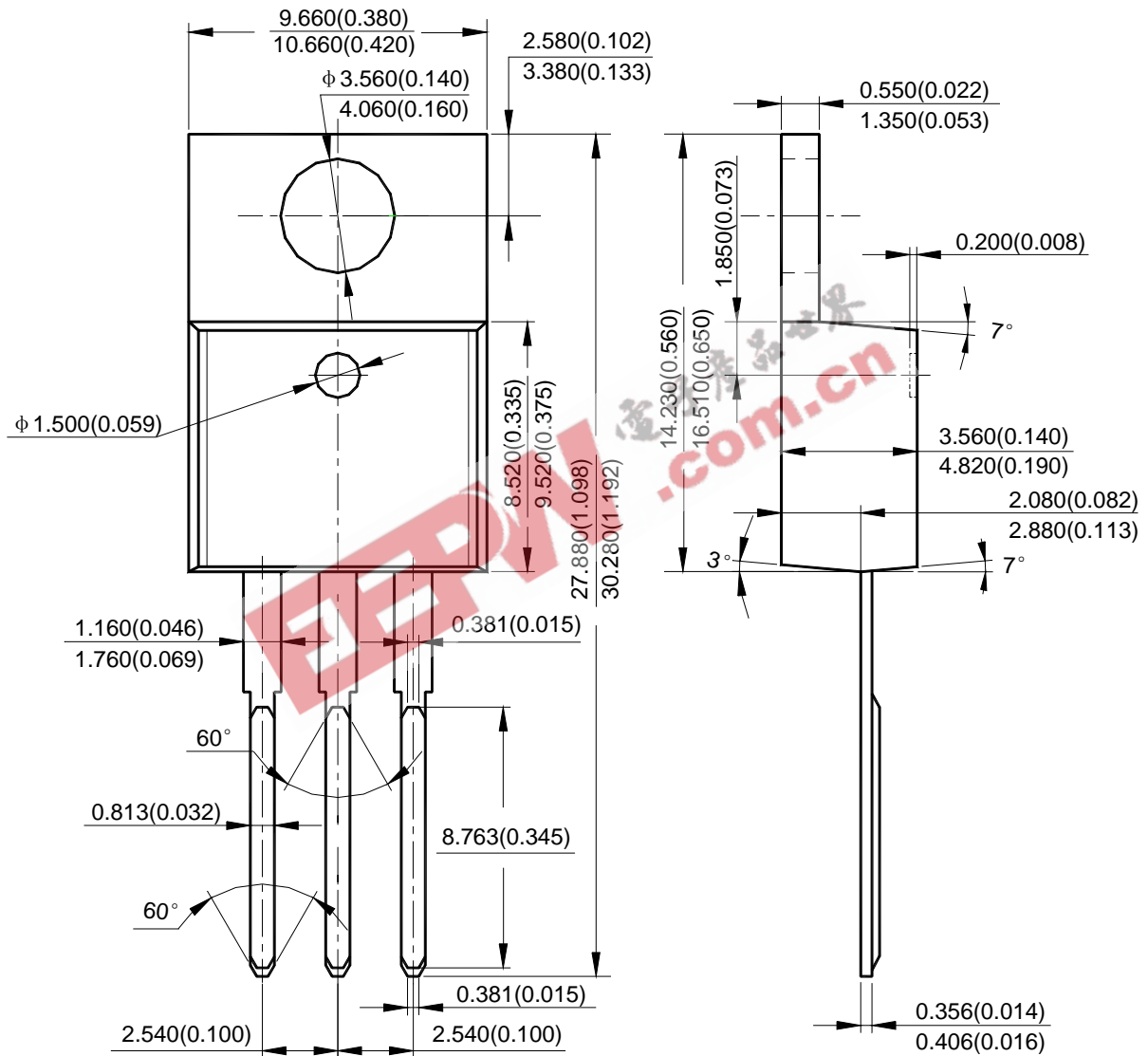



**1A ULTRA LOW DROPOUT LINEAR REGULATOR**

**AZ2940**

**Mechanical Dimensions (Continued)**

**TO-263-3**

**Unit: mm(inch)**

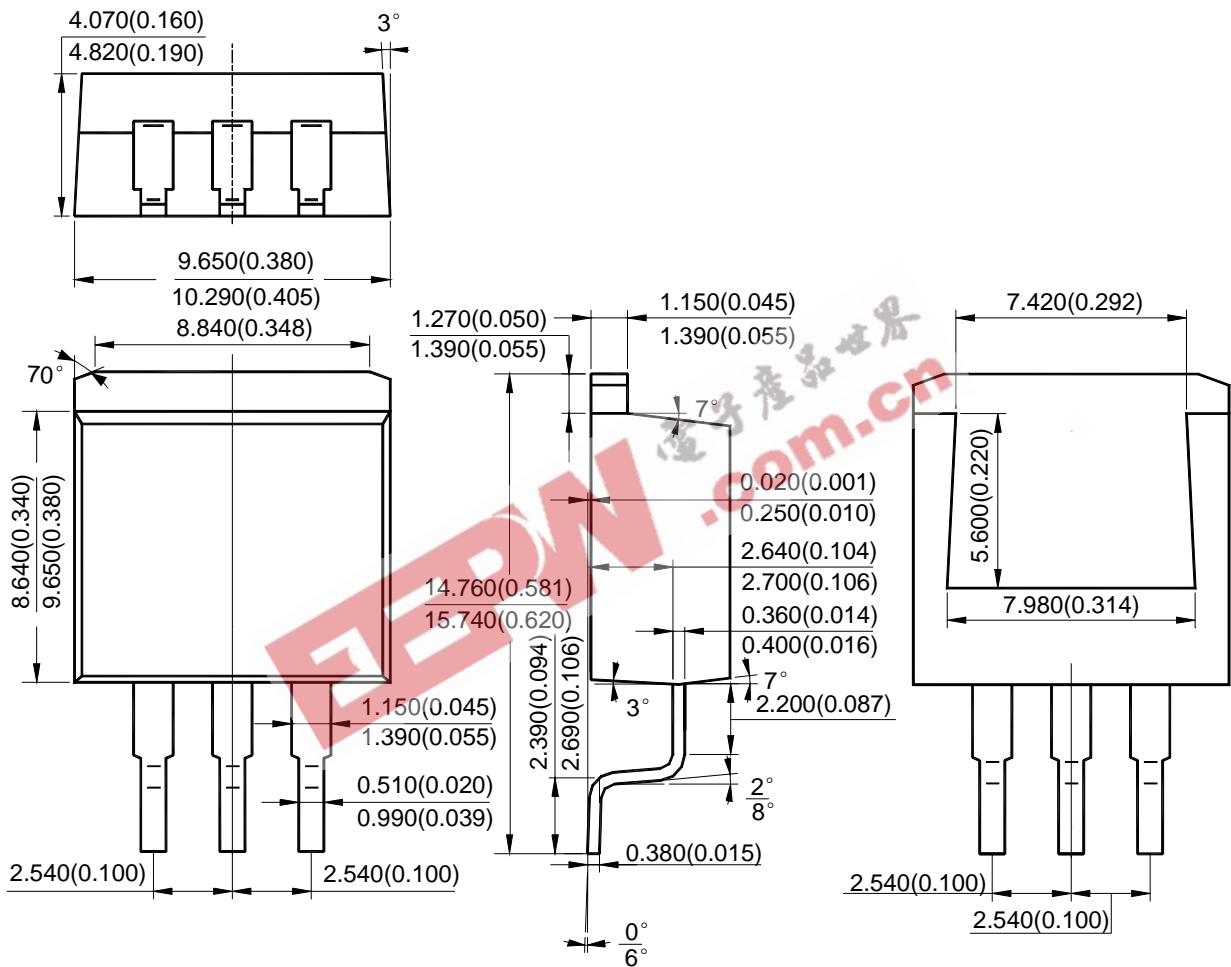







BCD Semiconductor Manufacturing Limited

<http://www.bcdsemi.com>

EPW.com.cn 电子产品世界

#### IMPORTANT NOTICE

BCD Semiconductor Manufacturing Limited reserves the right to make changes without further notice to any products or specifications herein. BCD Semiconductor Manufacturing Limited does not assume any responsibility for use of any its products for any particular purpose, nor does BCD Semiconductor Manufacturing Limited assume any liability arising out of the application or use of any its products or circuits. BCD Semiconductor Manufacturing Limited does not convey any license under its patent rights or other rights nor the rights of others.

---

#### MAIN SITE

**BCD Semiconductor Manufacturing Limited**  
- Wafer Fab  
Shanghai SIM-BCD Semiconductor Manufacturing Limited  
800, Yi Shan Road, Shanghai 200233, China  
Tel: +86-21-6485 1491, Fax: +86-21-5450 0008

**BCD Semiconductor Manufacturing Limited**  
- IC Design Group  
Advanced Analog Circuits (Shanghai) Corporation  
8F, Zone B, 900, Yi Shan Road, Shanghai 200233, China  
Tel: +86-21-6495 9539, Fax: +86-21-6485 9673

#### REGIONAL SALES OFFICE

**Shenzhen Office**  
Shanghai SIM-BCD Semiconductor Manufacturing Co., Ltd. Shenzhen Office  
Advanced Analog Circuits (Shanghai) Corporation Shenzhen Office  
27B, Tower C, 2070, Middle Shen Nan Road, Shenzhen 518031, China  
Tel: +86-755-8368 3987, Fax: +86-755-8368 3166

**Taiwan Office**  
BCD Semiconductor (Taiwan) Company Limited  
4F, 298-1, Rui Guang Road, Nei-Hu District, Taipei,  
Taiwan  
Tel: +886-2-2656 2808, Fax: +886-2-2656 2806

**USA Office**  
BCD Semiconductor Corporation  
3170 De La Cruz Blvd., Suite 105, Santa Clara,  
CA 95054-2411, U.S.A  
Tel: +1-408-988 6388, Fax: +1-408-988 6386