



FBA09A (92[□] x 25.5^L)



EMINEBEA.COM

General Specifications

Allowable Ambient Temperature Range:
 -10°C ~ +70°C (65%RH) (Operating)
 -40°C ~ +75°C (65%RH) (Storage)
 (non-condensing environment)

Expected Life

Failure Rate: 10%
 50,000 Hours (40°C, 65%RH)

Outline

Units: $\frac{\text{inch}}{\text{mm}}$

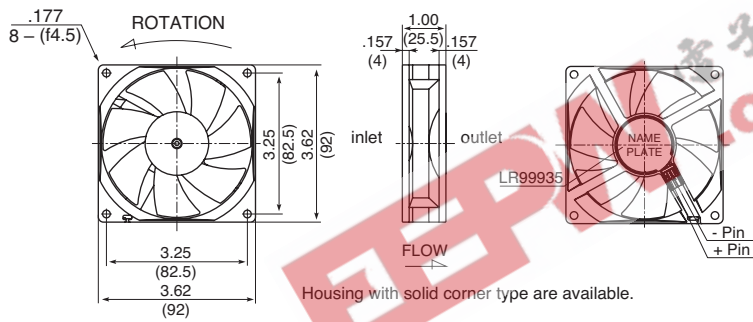

Characteristic Curves

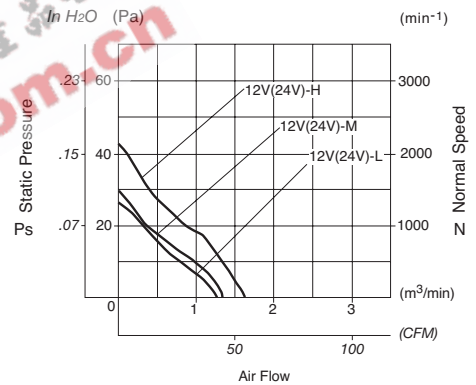

Panel Cut-outs

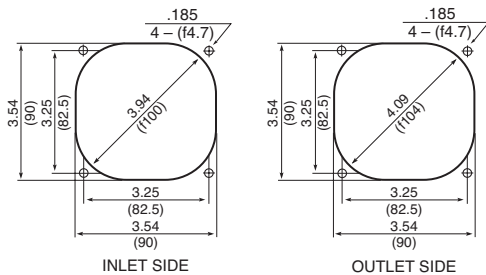

Material

Bearing: Hydro Wave Bearing

Specifications

MODEL	Rated Voltage	Operating Voltage	Current	Input Power	Rated Speed	Max. Air Flow		Max. Static Pressure		Noise	Mass
	(V)	(V)	(A) ^{*1}	(W) ^{*1}	(min ⁻¹) ^{*1}	CFM ^{*1}	(m ³ /min) ^{*1}	in H ₂ O	(Pa) ^{*1}	(dB) ^{*1}	(g)
FBA09A 12L	12	7.0 ~ 13.8	110	1.32	2200	42.7	1.21	.10	25.5	27.0	110
FBA09A 12M	12	7.0 ~ 13.8	150	1.80	2450	48.0	1.36	.11	29.4	30.0	110
FBA09A 12H	12	7.0 ~ 13.8	255	2.70	2950	56.8	1.61	.16	42.1	35.0	110
FBA09A 24L	24	14.0 ~ 27.6	80	1.92	2200	42.7	1.21	.10	25.5	27.0	110
FBA09A 24M	24	14.0 ~ 27.6	110	2.64	2450	48.0	1.36	.11	29.4	30.0	110
FBA09A 24H	24	14.0 ~ 27.6	140	3.36	2900	56.8	1.61	.16	42.1	35.0	110



Rotation: Clockwise





Airflow Outlet: Air Out Over Struts

*1: Average Values in Free Air

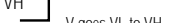
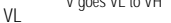
FEATURES

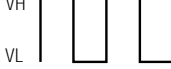
Specifications of Various Sensors

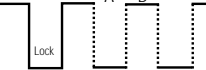
LOCKED ROTOR ALARM SIGNAL			
Signal given when fan is running	Signal given when fan is locked up	Available Models	Part Number Suffix
VH  VL 	VH  VL  V goes VL to VH	Axial models FBK04F	1BS S
		FAL	S
		FCB	S

2 PULSE PER REVOLUTION SIGNAL			
Signal given when fan is running	Signal given when fan is locked up	Available Models	Part Number Suffix
VH  VL 	Lock  If fan locks on VH, signal stays locked. If fan locks on VL, signal stays at VL for a few hundred MS, then moves to VH. (A:B - 1:5; A ≥ 100MS)	Axial models except: FBK04F FBA06T FBA08T FCB FAL	1BX
VL  2PPR			

In Panaflo FBA series models, a locked rotor alarm sensor is available in all models.

For Blowers and Crossflo fans, a locked sensor can be provided as an option.

A pulse sensor that transmits signals when the motor rotates is also available as an option.

The 2 pulse per revolution sensor output is available in all FBA Series models except the 15 mm "T" versions.

Panaflo Built-in Connector System



Lead Wire Connectors:

Style: MASS TERMINATION (standard)

AMP P/N 173977-3

CRIMP TYPE (this style is a 2 piece assembly)

AMP P/N 175778-3 (housing)

AMP P/N 175102-1 (terminal)

Notes:

- Connector style effects lead wire gauge. Please refer to fan specs for further details.
- All axial fans except the FBA06T, FBA08T and FBK04F versions come standard with the mass termination connector. The FBA06T, FBA08T and FBK04F fan leads are connected directly to the PC board in the fan assembly.
- All FCB Crossflo models and FAL Blower fan leads are soldered directly to the PC board in the fan assembly.

High Reliability with HWB (Hydro Wave Bearing)



Panflo's unique hydrowave bearing (HWB) addresses the traditional weakness of sleeve bearings... axial friction. By utilizing our unique HWB system, the thrust plate "floats" on a circulating film of oil, which greatly reduces the axial friction and the bearing's deterioration. The HWB pattern on the bearing virtually eliminates thrust plate contact which is depicted above.

As the shaft rotates it acts as a pump constantly circulating the oil in the radial, as well as the axial direction. The sealed system and reservoirs of oil maintain the proper lubrication to minimize mechanical contact and prolong the fan's life expectancy. The radial direction analysis shown above is essentially the same as a traditional sleeve bearing. Panasonic's unique HWB reduces the axial contact.

COMMON SPECIFICATIONS

Protection

- Locked rotor protection circuits
- Automatically restarts in a few seconds
- Reverse voltage protection

Insulation Resistance

- 10M Ω minimum at 500v DC (frame to leads)

Dielectric Strength

- 500v AC (50/60Hz) for 1 minute (frame to leads)

Plastic Rating

- All Panaflo fans are manufactured with a UL94V-0 plastic (flammability)

Insulation Class

- JIS Class E (120° C)
- VDE Class E (90° C)
- UL Class A (105° C)
- CSA Class A (105° C)

Noise Data



Noise Data

The noise data is measured at 1 meter from the air intake side of the fan suspended in a semi-anechoic chamber (background noise 13dB-A max.).

Construction with and without Solid Corner Housing

Panaflo fans are available in two different versions for mounting: with solid corner housing and without. Specific mounting methods and applications require the use of solid corners. Select the appropriate housing for your application. Some models may be available only with solid corner housing. For details, please refer to the corresponding page for each model.

With Solid Corner



Without Solid Corner



PANAFLO FAN PRODUCT DESIGNATION CODE

Panaflo Fan



Crossflo Fan



Blowers



Type and Size	Model	Rated Voltage (V)	Operating Voltage (V)	Rated Current (mA)	Rated Input (W)	Nominal Speed (r/min)	Maximum Air Flow		Maximum Air Pressure		Noise (dB-A)	Safety Standard UL CSA	Locked Rotor Alarm Sensor	
							(m3/min)	(CFM)	(mmh20)	(Pa)				
DC axial fans	FBK04F	5	4.5—6.0	120	0.60	4700	0.11	3.9	2.50	24.5	24.0	•	•	
	40mm	5	4.5—6.0	280	1.40	7500	0.19	6.7	6.60	64.7	33.0	•	•	
		FBK04F12L	12	7.0—13.8	75	0.90	4700	0.11	3.9	2.50	24.5	23.0	•	•
		FBK04F12H	12	7.0—13.8	150	1.80	7500	0.19	6.7	6.60	64.7	32.0	•	•
		FBK04F12U	12	7.0—13.8	170	2.04	9500	0.26	9.2	12.00	117.7	42.0	•	•
		FBK04F24H	24	14.0—27.6	92	2.21	7500	0.19	6.7	6.60	64.7	33.0	•	•
		FBK04F24U	24	14.0—27.6	100	2.40	9500	0.26	9.2	12.00	117.7	42.0	•	•
DC axial fans	FBA06A	12	7.0—13.8	110	1.32	3200	0.40	14.1	3.10	30.4	24.0	• •	•	
	60mm	FBA06A12M1A	12	7.0—13.8	130	1.56	3700	0.47	16.6	3.95	38.7	28.0	• •	•
		FBA06A12H1A	12	7.0—13.8	170	2.04	4200	0.54	19.1	5.20	51.0	32.0	• •	•
		FBA06A12U1A	12	7.0—13.8	210	2.52	4550	0.58	20.5	6.0	58.0	37.0	• •	•
		FBA06A24L1A	24	14.0—27.6	70	1.68	3200	0.40	14.1	3.10	30.4	24.0	• •	•
DC axial fans		FBA06A24M1A	24	14.0—27.6	90	2.16	3700	0.47	16.6	3.95	38.7	28.0	• •	•
		FBA06A24H1A	24	14.0—27.6	105	2.52	4200	0.54	19.1	5.20	51.0	32.0	• •	•
		FBA06T	12	7.0—13.8	88	1.06	3200	0.34	12.0	2.80	27.5	24.0	• •	•
	60mm	FBA06T12H	12	7.0—13.8	145	1.74	4200	0.47	16.6	4.75	46.6	32.0	• •	•
Thin		FBA06T24L	24	14—27.6	56	1.34	3200	0.34	12.0	2.80	27.5	24.0	• •	•
		FBA06T24H	24	14—27.6	83	1.99	4200	0.47	16.6	4.75	46.6	32.0	• •	•
DC axial fans	FBA08A	12	7.0—13.8	68	0.82	1900	0.68	24.0	1.57	15.4	21.0	• •	•	
	80mm	FBA08A12M1A	12	7.0—13.8	124	1.49	2450	0.91	32.1	2.51	24.6	28.0	• •	•
		FBA08A12H1A	12	7.0—13.8	173	2.08	2950	1.12	39.6	3.78	37.1	32.0	• •	•
		FBA08A12U1A	12	7.0—13.8	270	3.24	3450	1.33	46.9	4.80	47.0	38.2	• •	•
		FBA08A24L1A	24	14—27.6	54	1.30	1900	0.68	24.0	1.57	15.4	21.0	• •	•
DC axial fans		FBA08A24M1A	24	14—27.6	71	1.70	2450	0.91	32.1	2.51	24.6	28.0	• •	•
		FBA08A24H1A	24	14—27.6	105	2.52	2950	1.12	39.6	3.78	37.1	32.0	• •	•
		FBA08T	12	7.0—13.8	79	0.95	2000	0.62	21.9	1.55	15.2	23.0	• •	•
	80mm	FBA08T12H	12	7.0—13.8	200	2.40	3100	0.95	33.5	3.20	31.4	34.0	• •	•
Thin		FBA08T24L	24	14—27.6	47	1.13	2000	0.62	21.9	1.55	15.2	23.0	• •	•
		FBA08T24H	24	14—27.6	110	2.64	3100	0.95	33.5	3.20	31.4	34.0	• •	•
DC axial fans	FBA09A	12	7.0—13.8	110	1.32	2100	1.21	42.7	2.30	22.6	27.0	• •	•	
	90mm	FBA09A12M1A	12	7.0—13.8	150	1.80	2450	1.36	48.0	3.00	29.4	30.0	• •	•
		FBA09A12H1A	12	7.0—13.8	225	2.70	2850	1.61	56.8	3.98	39.0	35.0	• •	•
		FBA09A12U1A	12	7.0—13.8	430	5.16	3450	1.95	68.8	5.0	49.0	43.0	• •	•
		FBA09A24L1A	24	14—27.6	80	1.92	2100	1.21	42.7	2.30	22.6	27.0	• •	•
		FBA09A24M1A	24	14—27.6	110	2.64	2450	1.36	48.0	3.00	29.4	30.0	• •	•
DC axial fans		FBA09A24H1A	24	14—27.6	140	3.36	2850	1.61	56.8	3.98	39.0	35.0	• •	•
		FBA12G	12	7.0—13.8	180	2.16	1700	1.95	68.9	3.30	32.4	30.0	• •	•
	120mm	FBA12G12M1A	12	7.0—13.8	340	4.08	2100	2.45	86.5	4.80	47.1	35.5	• •	•
		FBA12G12H1A	12	7.0—13.8	460	5.52	2500	2.94	103.8	6.80	66.7	41.5	• •	•
		FBA12G12U1A	12	7.0—13.8	510	6.12	2750	3.25	114.7	8.0	38.0	45.5	• •	•
DC axial fans		FBA12G24L1A	24	14—27.6	110	2.64	1700	1.95	68.9	3.30	32.4	30.0	• •	•
		FBA12G24M1A	24	14—27.6	160	3.84	2100	2.45	86.5	4.80	47.1	35.5	• •	•
		FBA12G24H1A	24	14—27.6	230	5.52	2500	2.94	103.8	6.80	66.7	41.5	• •	•

DC AXIAL FANS

Type and Size	Model	Rated Voltage (V)	Operating Voltage (V)	Rated Current (mA)	Rated Input (W)	Nominal Speed (r/min)	Maximum Air Flow (m ³ /min) (CFM)	Maximum Air Pressure (mmh ₂ O) (Pa)	Noise (dB-A)	Safety Standard UL CSA	Locked Rotor Alarm Sensor			
CROSSFLO	Crossflo Fans	FCB34	FCB34AA12	12	10.2—13.8	165	1.98	2800	0.32	11.3	1.30	12.7	38.0	•
		FCB34AB12	12	10.2—13.8	340	4.08	3300	0.61	21.5	3.00	29.4	42.0	•	
		FCB34AC12	12	10.2—13.8	375	4.50	3100	0.80	28.2	2.00	19.6	42.0	•	
		FCB34AD12	12	10.2—13.8	415	4.98	3000	0.96	33.9	1.90	18.6	42.0	•	
		FCB34AE12	12	10.2—13.8	430	5.16	2900	1.14	40.3	1.90	18.6	42.0	•	
		FCB34AF12	12	10.2—13.8	440	5.28	2800	1.22	43.1	1.85	18.1	42.0	•	
		FCB34AA24	24	20.4—27.6	110	2.64	2800	0.33	11.7	1.50	14.7	39.0	•	
		FCB34AB24	24	20.4—27.6	165	3.96	3300	0.64	22.6	2.40	23.5	42.0	•	
		FCB34AC24	24	20.4—27.6	200	4.80	3100	0.80	28.2	2.00	19.6	42.0	•	
		FCB34AD24	24	20.4—27.6	210	5.04	3000	0.95	33.5	2.00	19.6	42.0	•	
		FCB34AE24	24	20.4—27.6	230	5.52	2900	1.10	38.8	2.10	20.6	42.0	•	
FCB34AF24	24	20.4—27.6	250	6.00	2800	1.15	40.6	2.20	21.6	42.0	• • •			
BLOWERS	FAL3F	Blowers	FAL3F05LH	5	4.5—6.0	205	1.64	4400	0.112	3.95	8.1	79.4	28.5	• • •
			FAL3F05LL	5	4.5—6.0	380	1.90	5400	0.140	4.94	15.4	151	36.0	• • •
			FAL3F12LL	24	7.0—13.8	111	1.33	4400	0.112	3.95	8.4	79.4	28.5	• • •
			FAL3F12LH	12	7.0—13.8	185	2.22	5200	0.138	4.87	15.0	151	35.0	• • •
	FAL3F24LH	24	14.0—27.6	105	2.52	5200	0.138	4.87	15.0	151	35.0	• • •		
	FAL5F		FAL5F12LH	12	7.0—13.8	200	2.40	2900	0.30	10.6	10.00	98.07	36.0	• • •
			FAL5F24LH	24	14—27.6	100	2.40	2900	0.30	10.6	9.70	95.12	36.0	• • •
			FAL5F12LL	12	7.0—13.8	140	1.68	2400	0.25	8.83	6.20	60.8	30.0	• • •
			FAL5F24LL	24	14—27.6	70	1.68	2400	0.25	8.83	6.30	61.8	30.0	• • •
	FAL6F		FAL6F12LL	12	7.0—13.8	280	3.36	2100	0.53	18.7	11.25	110.3	40.0	• • •
			FAL6F12LH	12	7.0—13.8	500	6.00	2550	0.65	23.0	18.00	176.5	45.0	• • •
			FAL6F24LL	24	14—27.0	155	3.72	2100	0.53	18.7	11.50	112.8	40.0	• • •
			FAL6F24LH	24	14—27.0	295	7.08	2550	0.67	23.7	19.70	193.2	45.0	• • •