

**GREEN MODE PWM CONTROLLER****AP384XG****General Description**

The AP384XG is a Green Mode PWM controller. It is specially designed for off-line AC-DC adapter and battery charger applications where both needs for low standby power and high efficiency in normal operation are required. In a well designed product, the AP384XG is capable to allow the system consuming only 0.5W power in standby mode.

In normal operation, the AP384XG features adjustable frequency by using an external resistor and capacitor combination. When output power falls below a given level, the IC automatically switches to the skip mode, which works by skipping switching cycles. The AP384XG also features low start-up and low standby operating current for its special topology.

The AP384XG provides accurate protection against over-temperature, over-current and maximal output power.

The AP384XG is available in SOIC-8 and DIP-8 packages.

**Features**

- Green Mode PWM Controller to Support the "Blue Angel" Norm
- Adjustable Skip Cycle Mode Operation
- Low Start-up Current: 40 $\mu$ A (Typ.)
- Low Standby Operating Current: 6mA
- Internal Leading Edge Blanking
- Adjustable Oscillator Frequency up to 500KHz
- Totem Pole Output
- Under Voltage Lock Out (UVLO)
- Over-Temperature Protection
- Pin to Pin Replacement for AZ384XA

**Applications**

- Off-line Converter
- DC-DC Converter
- DVD/STB Power Supply
- Power Adapter
- CRT Monitor Power Supply

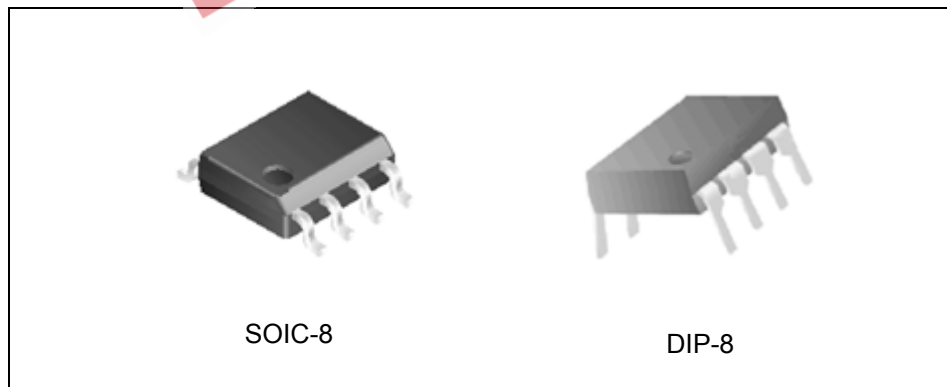

Figure 1. Package Types of AP384XG

**GREEN MODE PWM CONTROLLER****AP384XG****Pin Configuration**

Figure 2. Pin Configuration of AP384XG

**Pin Description**

Pin Number	Pin Name	Function
1	COMP	This pin is the Error Amplifier output and is made available for loop compensation.
2	FB	The inverting input of the Error Amplifier. It is normally connected to the switching power supply output through an external resistor divider.
3	CS	It is used either for current sense (normal mode) or skip cycle level selection (standby mode).
4	R <sub>T</sub> /C <sub>T</sub>	The oscillator frequency and maximum output duty cycle are programmed by connecting resistor R <sub>T</sub> to REF and capacitor C <sub>T</sub> to ground.
5	GND	The ground pin.
6	OUTPUT	This output directly drives the gate of a power MOSFET. Peak currents up to 1.0 A are sourced and sunk by this pin.
7	VCC	The power supply pin.
8	REF	This is the reference output. It provides charging current for capacitor C <sub>T</sub> through resistor R <sub>T</sub> .

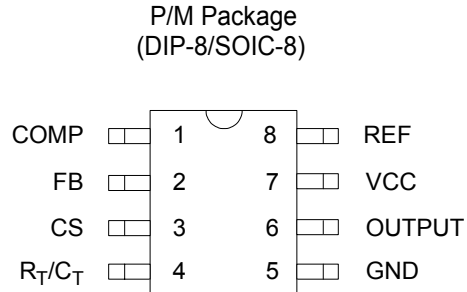

**GREEN MODE PWM CONTROLLER****AP384XG****Absolute Maximum Ratings (Note 1, 2)**

Parameter	Symbol	Value	Unit
Supply Voltage	V <sub>CC</sub>	30	V
Gate Output Current	I <sub>O</sub>	± 1	A
Analog Inputs (pin2, 3)	V(ANA)	-0.3 to 6.3	V
Error Amp Output Sink Current	I <sub>SINK(E.A)</sub>	20	mA
Power Dissipation at T <sub>A</sub> < 25 °C (DIP-8)	P <sub>D</sub> (Note 3)	1000	mW
Power Dissipation at T <sub>A</sub> < 25 °C (SOIC-8)	P <sub>D</sub> (Note 3)	460	mW
Storage Temperature Range	T <sub>STG</sub>	-65 to 150	°C
Ambient Temperature	T <sub>A</sub>	-40 to 85	°C
Lead Temperature (Soldering, 10sec)	T <sub>LEAD</sub>	+300	°C
ESD (Machine Model)		300	V

Note 1: Stresses greater than those listed under "Absolute Maximum Ratings" may cause permanent damage to the device. These are stress ratings only, and functional operation of the device at these or any other conditions beyond those indicated under "Recommended Operating Conditions" is not implied. Exposure to "Absolute Maximum Ratings" for extended periods may affect device reliability.

Note 2: All voltages are with respect to pin GND and all currents are positive into specified terminal.

Note 3: Board thickness 1.6mm, board dimension 90mm X 90mm.

**Recommended Operating Conditions**

Parameter	Symbol	Min	Max	Unit
Oscillation Frequency	f		500	KHz
Ambient Temperature	T <sub>A</sub>	-40	85	°C



**GREEN MODE PWM CONTROLLER**

**AP384XG**

**Electrical Characteristics**

( $V_{CC}=15V$ ,  $R_T=10k\Omega$   $C_T=3.3nF$ ,  $T_A= -40$  to  $85^\circ C$ , unless otherwise specified.)

Parameter	Symbol	Conditions	Min	Typ	Max	Unit
<b>REFERENCE SECTION</b>						
Reference Output Voltage	$V_{REF}$	$T_J=25^\circ C$ , $I_{REF}=1mA$	4.95	5.00	5.05	V
Total Output Variation		Line, Load, Temp.	4.9		5.10	V
Line Regulation	$\Delta V_{REF}$	$12V \leq V_{CC} \leq 25V$		4	15	mV
Load Regulation	$\Delta V_{REF}$	$1mA \leq I_{REF} \leq 20mA$		4	15	mV
Short Circuit Output Current	$I_{SC}$	$T_A=25^\circ C$		-100	-180	mA
Temperature Stability				0.2	0.4	mV/ $^\circ C$
<b>UNDER VOLTAGE LOCK OUT SECTION</b>						
Start-up Threshold		AP3842G/AP3844G	15	16	17	V
		AP3843G/AP3845G	7.8	8.4	9.0	
Minimum Operating Voltage		AP3842G/AP3844G	8.5	10	11.5	V
		AP3843G/AP3845G	7.0	7.6	8.2	
<b>TOTAL STANDBY CURRENT SECTION</b>						
Start-up Current		$V_{CC}=14V$		40	80	$\mu A$
Operating Current		$V_{FB}=0$ , $V_{CS}=0$ , $C_L=1nF$		8		mA
Standby Operating Current		$V_{FB}=2.7V$ , $V_{CS}=0.5V$		6		mA
Zener Voltage		$I_{CC}=25mA$	30	34		V
<b>PWM SECTION</b>						
Maximum Duty Cycle		AP3842G/AP3843G	94	96		%
		AP3844G/AP3845G	46	48	50	
Minimum Duty Cycle					0	%
<b>OSCILLATOR SECTION</b>						
Oscillation Frequency	f	$T_J=25^\circ C$	47	52	57	KHz
Oscillator Amplitude	$V_{OSC}$	Pin RT/CT, peak to peak		1.7		V
Temperature Stability				2		%
Voltage Stability		$12V \leq V_{CC} \leq 25V$		0.2	1	%
Discharge Current		$V_{RT/CT} = 2V$ (Note 4)	8.5	9.5	10.5	mA

Note 4: This parameter is measured with  $R_T=10k\Omega$  to  $V_{REF}$ , it contributes 0.3mA of current to the measured value. So the total current flowing into the CT pin will be 0.3mA higher than the measured value approximately.



**GREEN MODE PWM CONTROLLER**

**AP384XG**

**Electrical Characteristics (Continued)**

Parameter	Symbol	Conditions	Min	Typ	Max	Unit
<b>ERROR AMPLIFIER SECTION</b>						
Input Voltage	V <sub>I</sub>	V <sub>COMP</sub> =2.5V	2.45	2.50	2.55	V
Output Sink Current	I <sub>SINK</sub>	V <sub>COMP</sub> =1.1V	6	10		mA
Output Source Current	I <sub>SOURCE</sub>	V <sub>COMP</sub> =5V	-0.5	-0.8		mA
High Output Voltage	V <sub>OH</sub>	R <sub>L</sub> =15kΩ to GND	5	7		V
Low Output Voltage	V <sub>OL</sub>	R <sub>L</sub> =15kΩ to pin REF		0.7	1.1	V
Voltage Gain		2V ≤ V <sub>O</sub> ≤ 4V	65	90		dB
Power Supply Rejection Ratio	PSRR	12V ≤ V <sub>CC</sub> ≤ 25V	60	70		dB
<b>CURRENT SENSE SECTION</b>						
Maximum Input Signal	V <sub>I</sub> (MAX)	V <sub>COMP</sub> =5V (Note 5)	0.9	1	1.1	V
Gain	GV	0V ≤ V <sub>CS</sub> ≤ 4V (Note 5, 6)	2.85	3	3.15	V/V
Power Supply Rejection Ratio	PSRR	12V ≤ V <sub>CC</sub> ≤ 25V (Note 5, 7)		70		dB
Delay to Output		V <sub>CS</sub> = 0 to 2V (Note 7)		150	250	ns
Input Bias Current	I <sub>BIAS</sub>	V <sub>OUTPUT</sub> =High		-3	-10	μA
Leading Edge Blanking Duration	T <sub>LEB</sub>			250		ns
<b>OUTPUT SECTION</b>						
Low Output Voltage	V <sub>OL</sub>	I <sub>SINK</sub> = 20mA		0.2	0.4	V
		I <sub>SINK</sub> = 200mA		1.4	2.2	V
High Output Voltage	V <sub>OH</sub>	I <sub>SOURCE</sub> = 20mA	13	13.5		V
		I <sub>SOURCE</sub> = 200mA	12	13		V
Rise Time	t <sub>R</sub>	T <sub>J</sub> =25°C, C <sub>L</sub> =1nF		150	250	ns
Fall Time	t <sub>F</sub>	T <sub>J</sub> =25°C, C <sub>L</sub> =1nF		50	150	ns
<b>SKIP CYCLE MODE SECTION</b>						
Source Current (@ CS)		V <sub>OUTPUT</sub> =Low, T <sub>J</sub> =25°C	180	200	220	μA
<b>OVER-TEMPERATURE PROTECT SECTION</b>						
Shutdown Temperature	T <sub>SHUT</sub>			155		°C
Temperature Hysteresis	T <sub>HYS</sub>			25		°C

Note 5: Parameters are tested at trip point of latch with V<sub>pin2</sub> = 0.

Note 6: Here gain is defined as:

$$A = \frac{\Delta V_{Pin 1}}{\Delta V_{Pin 3}}, 0 \leq V_{pin3} \leq 0.8V$$

Note 7: These parameters, although guaranteed, are not 100% tested in production.

**GREEN MODE PWM CONTROLLER****AP384XG****Electrical Characteristics (Continued)**

Figure 4. Basic Test Circuit

Figure 4 is the basic test circuit for AP384XG. In testing, the high peak currents associated with capacitive loads necessitate careful grounding techniques. Timing and bypass capacitors should be connected close to pin 5 in a single point ground. The transistor and 5k potentiometer are used to sample the oscillator waveform and apply an adjustable ramp to pin 3.

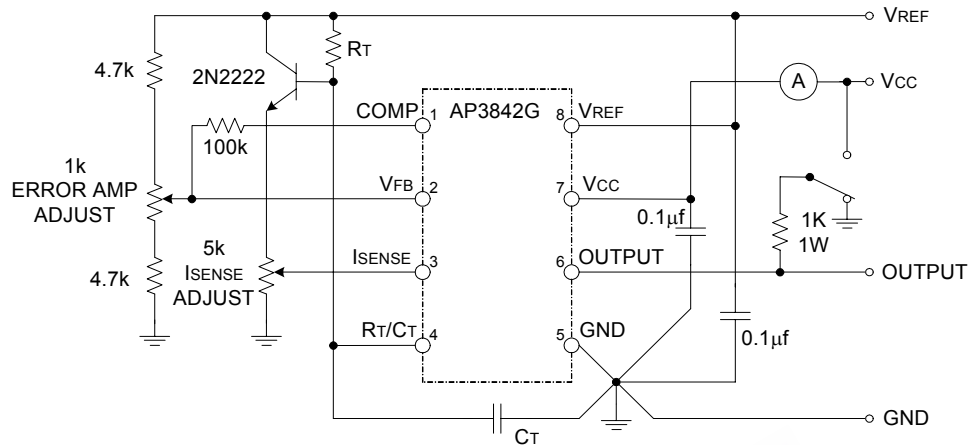

**GREEN MODE PWM CONTROLLER**

**AP384XG**

**Typical Performance Characteristics**

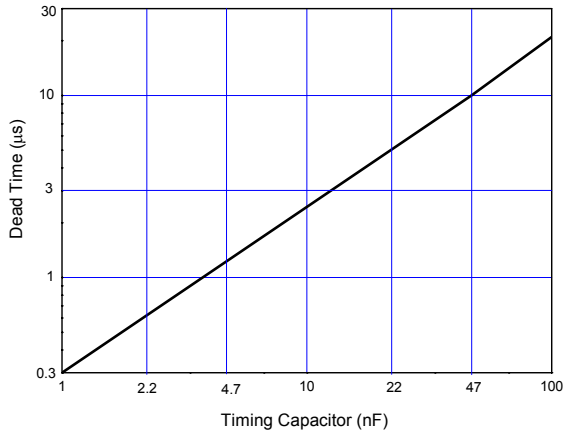

Figure 5. Oscillator Dead Time vs. Timing Capacitor

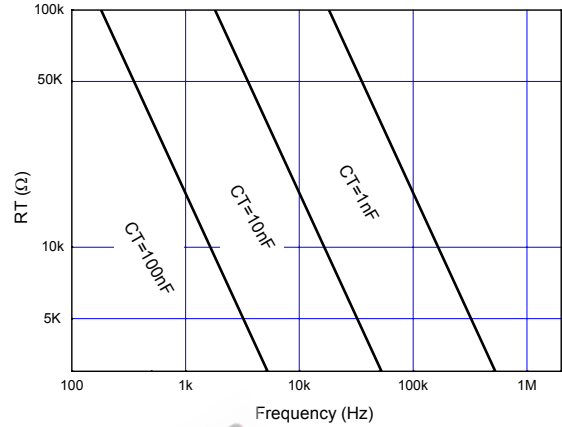

Figure 6. Timing Resistor vs. Frequency

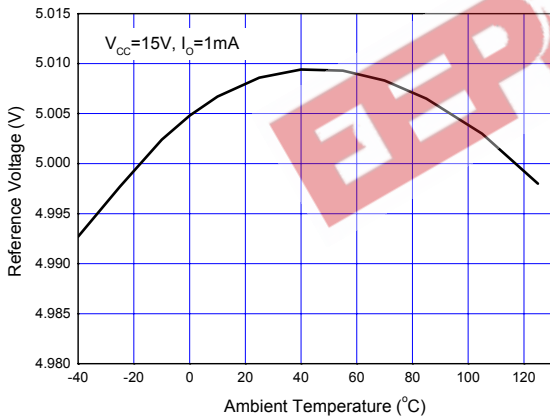

Figure 7. Reference Voltage vs. Ambient Temperature

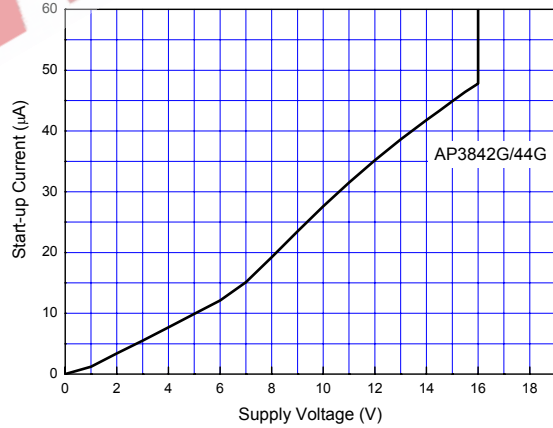

Figure 8. Start-up Current vs. Supply Voltage





**GREEN MODE PWM CONTROLLER**

**AP384XG**

**Typical Performance Characteristics (Continued)**

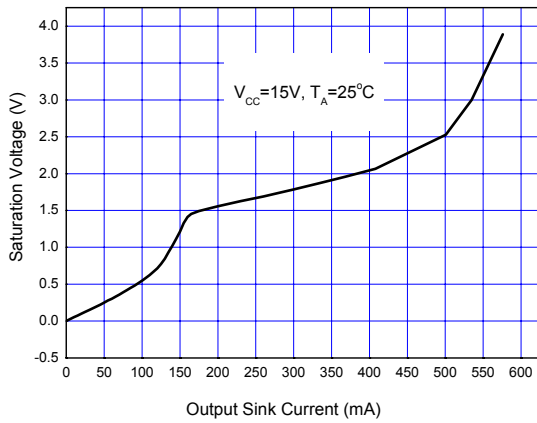

Figure 9. Output Saturation Characteristics

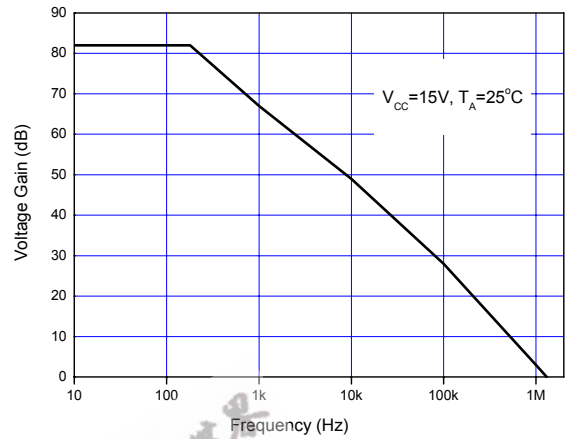

Figure 10. Error Amplifier Open-Loop Frequency Response

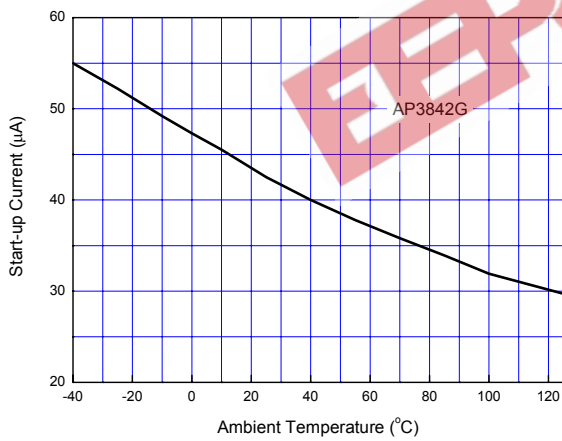

Figure 11. Start-up Current vs. Ambient Temperature

