

PNP Silicon AF Transistors

- For general AF applications
- High current gain
- Low collector-emitter saturation voltage
- Complementary types: BCW65, BCW66 (NPN)

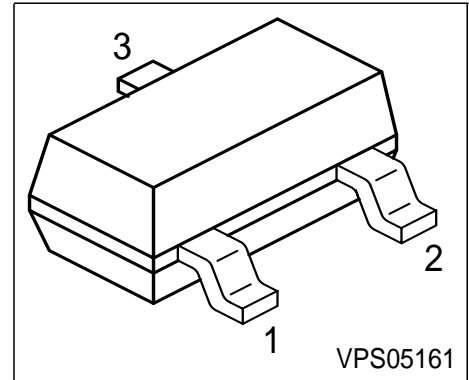

Type	Marking	Pin Configuration			Package
BCW67A	DAs	1 = B	2 = E	3 = C	SOT23
BCW67B	DBs	1 = B	2 = E	3 = C	SOT23
BCW67C	DCs	1 = B	2 = E	3 = C	SOT23
BCW68F	DFs	1 = B	2 = E	3 = C	SOT23
BCW68G	DGs	1 = B	2 = E	3 = C	SOT23
BCW68H	DHs	1 = B	2 = E	3 = C	SOT23

Maximum Ratings

Parameter	Symbol	BCW67	BCW68	Unit
Collector-emitter voltage	V_{CEO}	32	45	V
Collector-base voltage	V_{CBO}	45	60	
Emitter-base voltage	V_{EBO}	5	5	
DC collector current	I_C	800		mA
Peak collector current	I_{CM}	1		A
Base current	I_B	100		mA
Peak base current	I_{BM}	200		
Total power dissipation, $T_S = 79\text{ °C}$	P_{tot}	330		mW
Junction temperature	T_j	150		°C
Storage temperature	T_{stg}	-65 ... 150		

Thermal Resistance

Junction - soldering point ¹⁾	R_{thJS}	≤215	K/W
--	------------	------	-----

¹⁾For calculation of R_{thJA} please refer to Application Note Thermal Resistance

Electrical Characteristics at $T_A = 25^\circ\text{C}$, unless otherwise specified.

Parameter	Symbol	Values			Unit
		min.	typ.	max.	
DC Characteristics					
Collector-emitter breakdown voltage $I_C = 10\text{ mA}, I_B = 0$	$V_{(BR)CEO}$				V
BCW67		32	-	-	
BCW68		45	-	-	
Collector-base breakdown voltage $I_C = 10\text{ }\mu\text{A}, I_B = 0$	$V_{(BR)CBO}$				
BCW67		45	-	-	
BCW68		60	-	-	
Emitter-base breakdown voltage $I_E = 10\text{ }\mu\text{A}, I_C = 0$	$V_{(BR)EBO}$	5	-	-	
Collector cutoff current $V_{CB} = 32\text{ V}, I_E = 0$	I_{CBO}				nA
BCW67		-	-	20	
$V_{CB} = 45\text{ V}, I_E = 0$	BCW68			20	
Collector cutoff current $V_{CB} = 32\text{ V}, I_E = 0, T_A = 150^\circ\text{C}$	I_{CBO}				μA
BCW67		-	-	20	
$V_{CB} = 45\text{ V}, I_E = 0, T_A = 150^\circ\text{C}$	BCW68			20	
Emitter cutoff current $V_{EB} = 4\text{ V}, I_C = 0$	I_{EBO}	-	-	20	nA
DC current gain 1) $I_C = 100\text{ }\mu\text{A}, V_{CE} = 10\text{ V}$	h_{FE}				-
h_{FE} -grp. A/F		35	-	-	
h_{FE} -grp. B/G		50	-	-	
h_{FE} -grp. C/H		80	-	-	
DC current gain 1) $I_C = 10\text{ mA}, V_{CE} = 1\text{ V}$	h_{FE}				
h_{FE} -grp. A/F		75	-	-	
h_{FE} -grp. B/G		120	-	-	
h_{FE} -grp. C/H		180	-	-	
DC current gain 1) $I_C = 100\text{ mA}, V_{CE} = 1\text{ V}$	h_{FE}				
h_{FE} -grp. A/F		100	160	250	
h_{FE} -grp. B/G		160	250	400	
h_{FE} -grp. C/H		250	350	630	

 1) Pulse test: $t \leq 300\text{ }\mu\text{s}$, $D = 2\%$

Electrical Characteristics at $T_A = 25^\circ\text{C}$, unless otherwise specified.

Parameter	Symbol	Values			Unit
		min.	typ.	max.	
DC Characteristics					
DC current gain 1) $I_C = 500 \text{ mA}, V_{CE} = 2 \text{ V}$	h_{FE}				-
$h_{FE}\text{-grp. A/F}$		35	-	-	
$h_{FE}\text{-grp. B/G}$		60	-	-	
$h_{FE}\text{-grp. C/H}$		100	-	-	
Collector-emitter saturation voltage1) $I_C = 100 \text{ mA}, I_B = 10 \text{ mA}$ $I_C = 500 \text{ mA}, I_B = 50 \text{ mA}$	V_{CEsat}				V
		-	-	0.3	
		-	-	0.7	
Base-emitter saturation voltage 1) $I_C = 100 \text{ mA}, I_B = 10 \text{ mA}$ $I_C = 500 \text{ mA}, I_B = 50 \text{ mA}$	V_{BEsat}				
		-	-	1.25	
		-	-	2	
AC Characteristics					
Transition frequency $I_C = 50 \text{ mA}, V_{CE} = 5 \text{ V}, f = 20 \text{ MHz}$	f_T	-	200	-	MHz
Collector-base capacitance $V_{CB} = 10 \text{ V}, f = 1 \text{ MHz}$	C_{cb}	-	6	-	pF
Emitter-base capacitance $V_{EB} = 0.5 \text{ V}, f = 1 \text{ MHz}$	C_{eb}	-	60	-	

Total power dissipation $P_{tot} = f(T_S)$

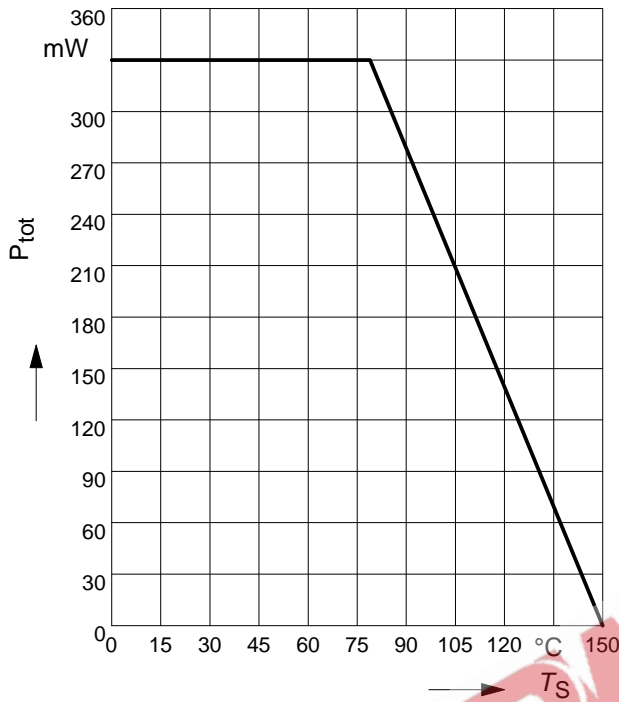

Transition frequency $f_T = f(I_C)$

$V_{CE} = 5V$

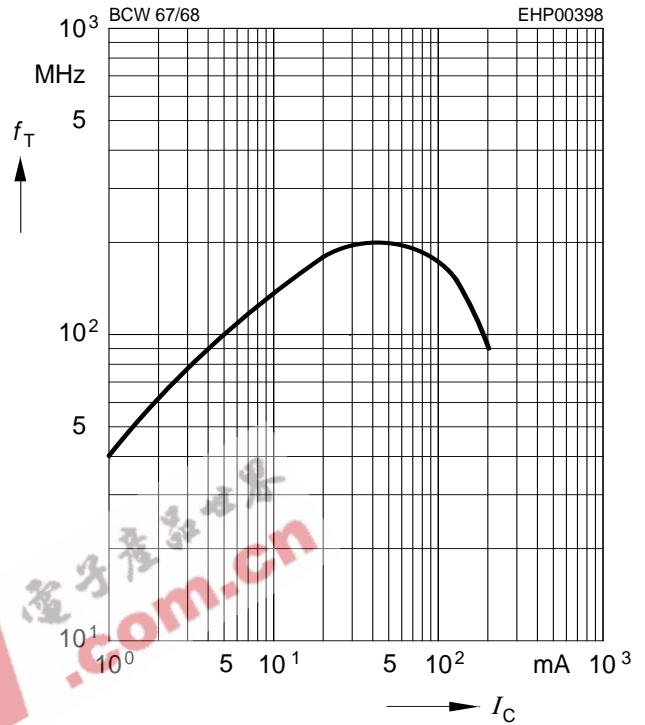

Permissible pulse load

$P_{totmax} / P_{totDC} = f(t_p)$

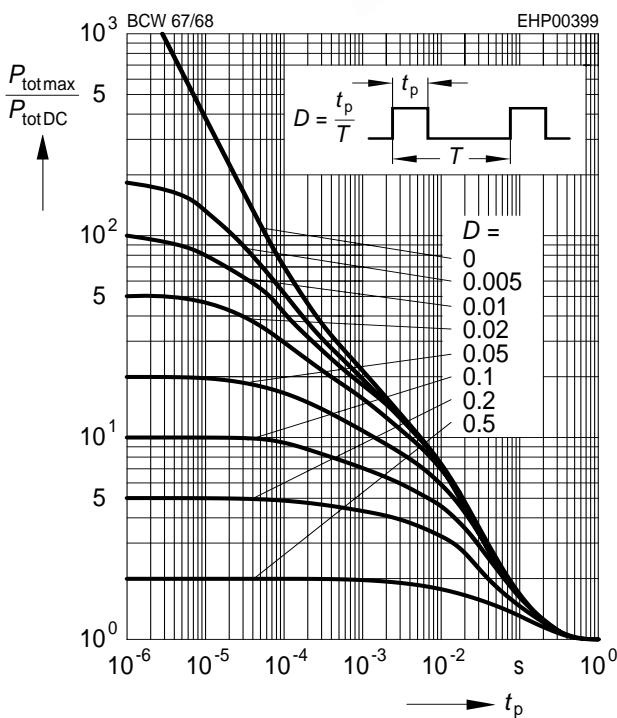

Collector cutoff current $I_{CBO} = f(T_A)$

$V_{CB} = V_{CEmax}$

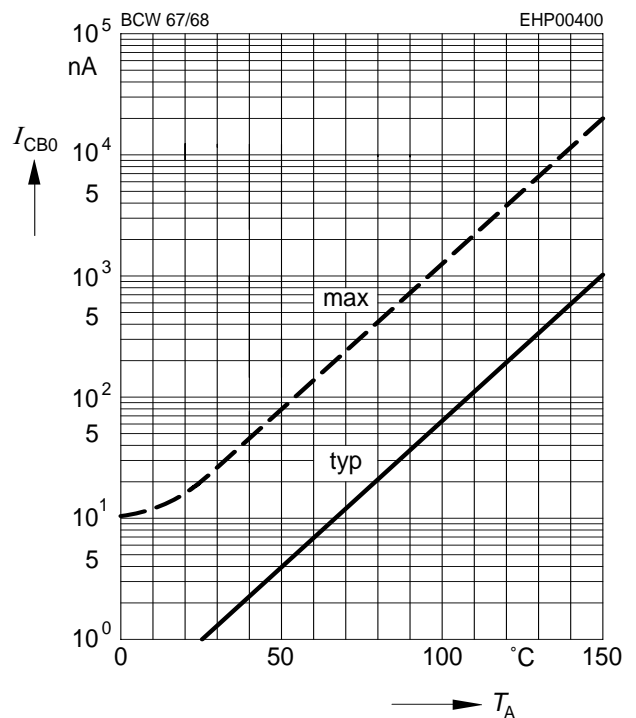

Base-emitter saturation voltage

$$I_C = f(V_{BEsat}), h_{FE} = 10$$

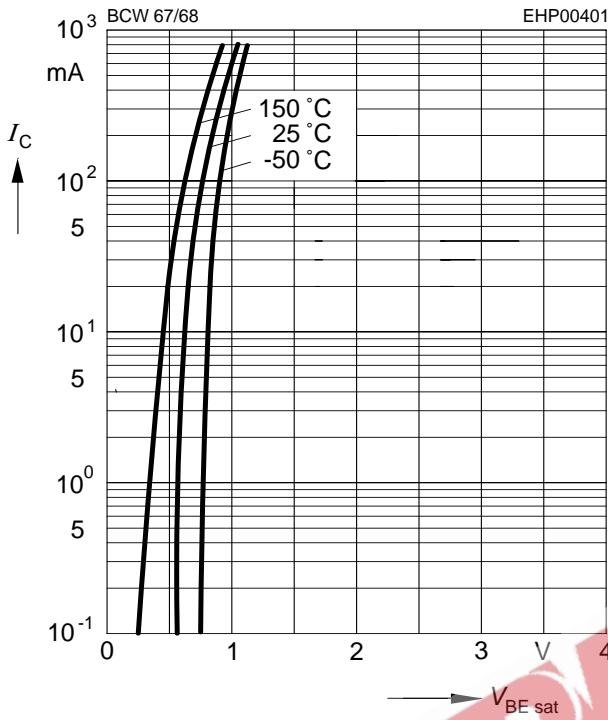

Collector-emitter saturation voltage

$$I_C = f(V_{CEsat}), h_{FE} = 10$$

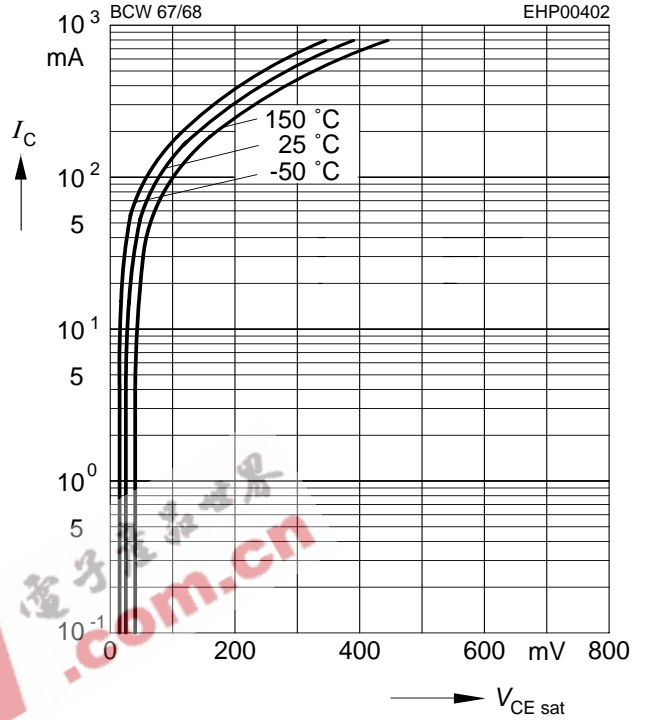

DC current gain $h_{FE} = f(I_C)$

$$V_{CE} = 1V$$

