

**LOW NOISE GENERAL PURPOSE AUDIO AMPLIFIERS**

**DESCRIPTION**

The BC107 and BC108 are silicon planar epitaxial NPN transistors in TO-18 metal case. They are suitable for use in driver stages, low noise input stages and signal processing circuits of television receivers. The PNP complement for BC107 is BC177.

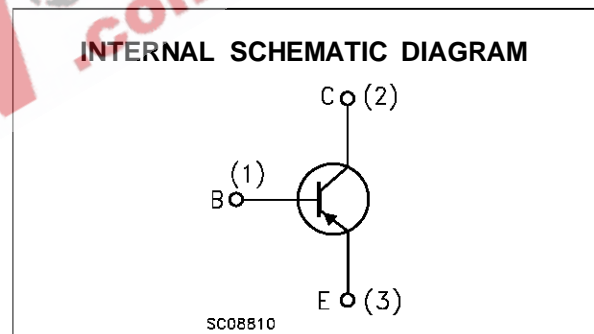
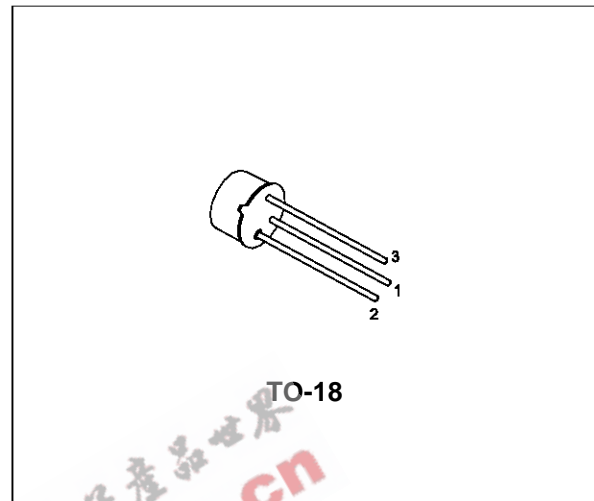

**ABSOLUTE MAXIMUM RATINGS**

Symbol	Parameter	Value		Unit
		BC107	BC108	
$V_{CBO}$	Collector-Base Voltage ( $I_E = 0$ )	50	30	V
$V_{CEO}$	Collector-Emitter Voltage ( $I_B = 0$ )	45	20	V
$V_{EBO}$	Emitter-Base Voltage ( $I_C = 0$ )	6	5	V
$I_C$	Collector Current	100		mA
$P_{tot}$	Total Dissipation at $T_{amb} \leq 25\text{ }^\circ\text{C}$ at $T_{case} \leq 25\text{ }^\circ\text{C}$	0.3		W
		0.75		W
$T_{stg}$	Storage Temperature	-55 to 175		$^\circ\text{C}$
$T_j$	Max. Operating Junction Temperature	175		$^\circ\text{C}$

# BC107/BC108

## THERMAL DATA

R <sub>thj-case</sub>	Thermal Resistance Junction-Case	Max	200	°C/W
R <sub>thj-amb</sub>	Thermal Resistance Junction-Ambient	Max	500	°C/W

## ELECTRICAL CHARACTERISTICS (T<sub>case</sub> = 25 °C unless otherwise specified)

Symbol	Parameter	Test Conditions	Min.	Typ.	Max.	Unit
I <sub>CBO</sub>	Collector Cut-off Current (I <sub>E</sub> = 0)	for <b>BC107</b> V <sub>CB</sub> = 40 V V <sub>CB</sub> = 40 V T <sub>case</sub> = 150 °C for <b>BC108</b> V <sub>CB</sub> = 20 V V <sub>CB</sub> = 20 V T <sub>case</sub> = 150 °C			15 15 15 15	nA μA μA μA
V <sub>(BR)CBO</sub>	Collector-Base Breakdown Voltage (I <sub>E</sub> = 0)	I <sub>C</sub> = 10 μA for <b>BC107</b> for <b>BC108</b>	50 30			V V
V <sub>(BR)CEO</sub> *	Collector-Emitter Breakdown Voltage (I <sub>B</sub> = 0)	I <sub>C</sub> = 10 mA for <b>BC107</b> for <b>BC108</b>	45 20			V V
V <sub>(BR)EBO</sub>	Emitter-Base Breakdown Voltage (I <sub>C</sub> = 0)	I <sub>E</sub> = 10 μA for <b>BC107</b> for <b>BC108</b>	6 5			V V
V <sub>CE(sat)</sub> *	Collector-Emitter Saturation Voltage	I <sub>C</sub> = 10 mA I <sub>B</sub> = 0.5 mA I <sub>C</sub> = 100 mA I <sub>B</sub> = 5 mA		70 200	250 600	mV mV
V <sub>BE(sat)</sub> *	Base-Emitter Saturation Voltage	I <sub>C</sub> = 10 mA I <sub>B</sub> = 0.5 mA I <sub>C</sub> = 100 mA I <sub>B</sub> = 5 mA		750 950		mV mV
V <sub>BE(on)</sub> *	Base-Emitter On Voltage	I <sub>C</sub> = 2 mA V <sub>CE</sub> = 5 V I <sub>C</sub> = 10 mA V <sub>CE</sub> = 5 V	550	650 700	700 770	mV mV
h <sub>FE</sub> *	DC Current Gain	I <sub>C</sub> = 2 mA V <sub>CE</sub> = 5 V for <b>BC107</b> for <b>BC107</b> Gr. A for <b>BC107</b> Gr. B for <b>BC108</b> for <b>BC108</b> Gr. A for <b>BC108</b> Gr. B for <b>BC108</b> Gr. C I <sub>C</sub> = 10 μA V <sub>CE</sub> = 5 V for <b>BC107</b> for <b>BC107</b> Gr. A for <b>BC107</b> Gr. B for <b>BC108</b> for <b>BC108</b> Gr. A for <b>BC108</b> Gr. B for <b>BC108</b> Gr. C	110 110 200 110 110 200 420  40 100		450 220 450 800 220 450 800  120 90 150 120 90 150 270	
h <sub>fe</sub> *	Small Signal Current Gain	I <sub>C</sub> = 2 mA V <sub>CE</sub> = 5 V f = 1KHz for <b>BC107</b> for <b>BC107</b> Gr. A for <b>BC107</b> Gr. B for <b>BC108</b> for <b>BC108</b> Gr. A for <b>BC108</b> Gr. B for <b>BC108</b> Gr. C I <sub>C</sub> = 10 mA V <sub>CE</sub> = 10 V f = 100 MHz		250 190 300 370 190 300 500 2		

\* Pulsed: Pulse duration = 300 μs, duty cycle ≤ 1 %

**ELECTRICAL CHARACTERISTICS** (continued)

Symbol	Parameter	Test Conditions	Min.	Typ.	Max.	Unit
C <sub>CB0</sub>	Collector Base Capacitance	I <sub>E</sub> = 0 V <sub>CB</sub> = 10 V f = 1MHz		4	6	pF
C <sub>EBO</sub>	Emitter Base Capacitance	I <sub>C</sub> = 0 V <sub>EB</sub> = 0.5 V f = 1MHz		12		pF
NF	Noise Figure	I <sub>C</sub> = 0.2 mA V <sub>CE</sub> = 5 V f = 1KHz R <sub>g</sub> = 2KΩ B = 200Hz		2	10	dB
h <sub>ie</sub>	Input Impedance	I <sub>C</sub> = 2 mA V <sub>CE</sub> = 5 V f = 1KHz for <b>BC107</b> for <b>BC107</b> Gr. A for <b>BC107</b> Gr. B for <b>BC108</b> for <b>BC108</b> Gr. A for <b>BC108</b> Gr. B for <b>BC108</b> Gr. C		4 3 4.8 5.5 3 4.8 7		KΩ KΩ KΩ KΩ KΩ KΩ KΩ
h <sub>re</sub>	Reverse Voltage Ratio	I <sub>C</sub> = 2 mA V <sub>CE</sub> = 5 V f = 1KHz for <b>BC107</b> for <b>BC107</b> Gr. A for <b>BC107</b> Gr. B for <b>BC108</b> for <b>BC108</b> Gr. A for <b>BC108</b> Gr. B for <b>BC108</b> Gr. C		2.2 1.7 2.7 3.1 1.7 2.7 3.8		10 <sup>-4</sup> 10 <sup>-4</sup> 10 <sup>-4</sup> 10 <sup>-4</sup> 10 <sup>-4</sup> 10 <sup>-4</sup> 10 <sup>-4</sup>
h <sub>oe</sub>	Output Admittance	I <sub>C</sub> = 2 mA V <sub>CE</sub> = 5 V f = 1KHz for <b>BC107</b> for <b>BC107</b> Gr. A for <b>BC107</b> Gr. B for <b>BC108</b> for <b>BC108</b> Gr. A for <b>BC108</b> Gr. B for <b>BC108</b> Gr. C		30 13 26 30 13 26 34		μS μS μS μS μS μS μS

\* Pulsed: Pulse duration = 300 μs, duty cycle ≤ 1 %

DC Normalized Current Gain.

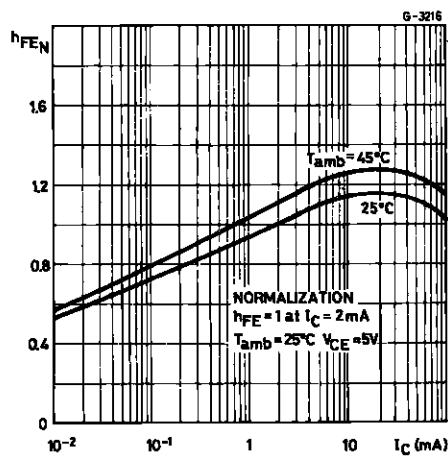

Collector--emitter Saturation Voltage.

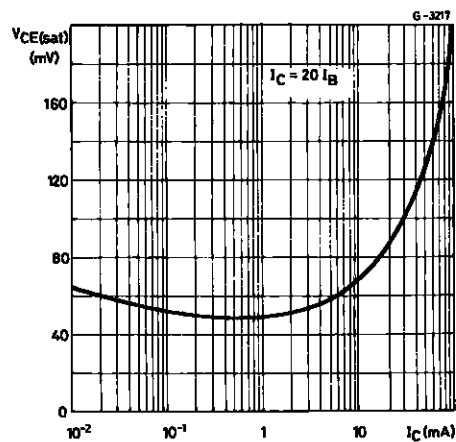

Collector-base Capacitance.

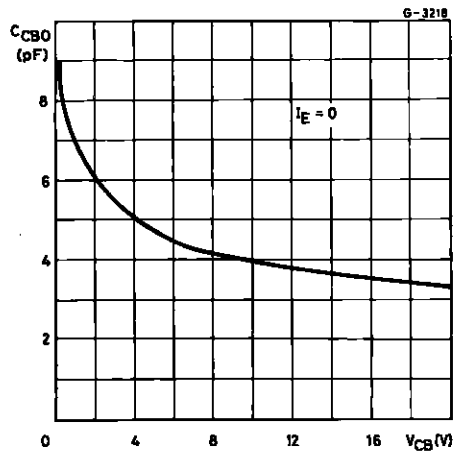

Transition Frequency.

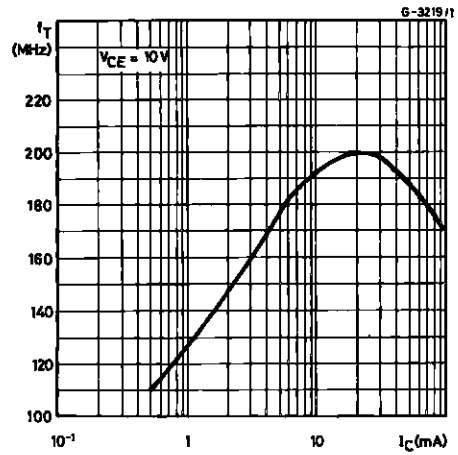

Power Rating Chart.

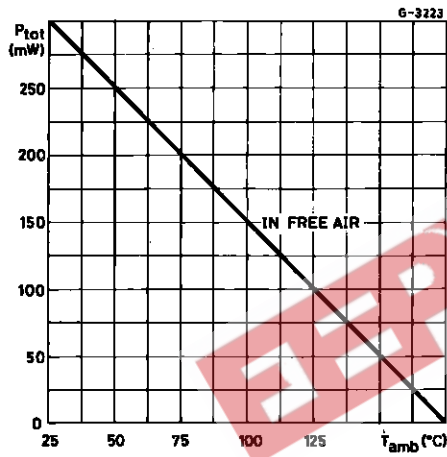

电子产品世界  
EEPW.com.cn

## TO-18 MECHANICAL DATA

DIM.	mm			inch		
	MIN.	TYP.	MAX.	MIN.	TYP.	MAX.
A		12.7			0.500	
B			0.49			0.019
D			5.3			0.208
E			4.9			0.193
F			5.8			0.228
G	2.54			0.100		
H			1.2			0.047
I			1.16			0.045
L	45°			45°		

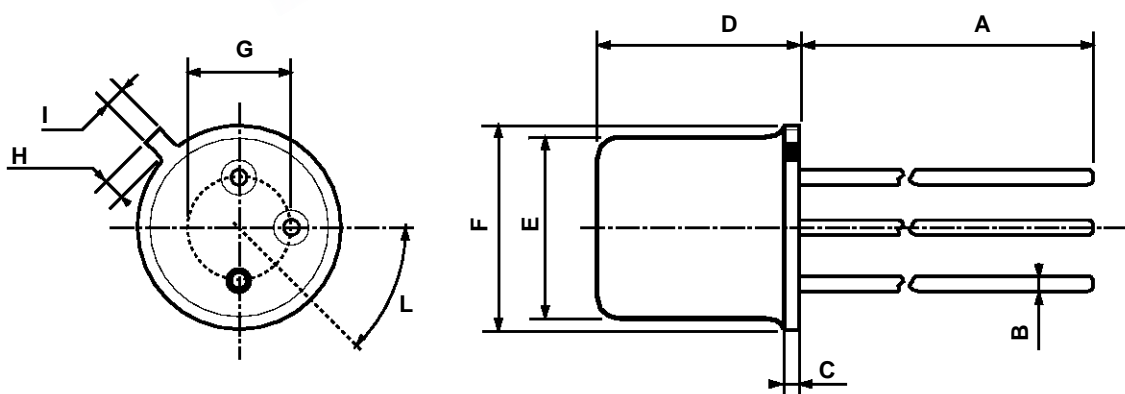

0016043

EEPW 电子产品世界  
.com.cn

Information furnished is believed to be accurate and reliable. However, SGS-THOMSON Microelectronics assumes no responsibility for the consequences of use of such information nor for any infringement of patents or other rights of third parties which may result from its use. No license is granted by implication or otherwise under any patent or patent rights of SGS-THOMSON Microelectronics. Specifications mentioned in this publication are subject to change without notice. This publication supersedes and replaces all information previously supplied. SGS-THOMSON Microelectronics products are not authorized for use as critical components in life support devices or systems without express written approval of SGS-THOMSON Microelectronics.

© 1997 SGS-THOMSON Microelectronics - Printed in Italy - All Rights Reserved

SGS-THOMSON Microelectronics GROUP OF COMPANIES

Australia - Brazil - Canada - China - France - Germany - Italy - Japan - Korea - Malaysia - Malta - Morocco - The Netherlands -  
Singapore - Spain - Sweden - Switzerland - Taiwan - Thailand - United Kingdom - U.S.A

...