

NPN Silicon AF Transistors

BCX 68

- For general AF applications
- High collector current
- High current gain
- Low collector-emitter saturation voltage
- Complementary type: BCX 69 (PNP)



| Type | Marking | Ordering Code (tape and reel) | Pin Configuration | | | Package ¹⁾ |
|-----------|---------|----------------------------------|-------------------|---|---|-----------------------|
| | | | 1 | 2 | 3 | |
| BCX 68 | – | Q62702-C1572 | B | C | E | SOT-89 |
| BCX 68-10 | CB | Q62702-C1864 | | | | |
| BCX 68-16 | CC | Q62702-C1865 | | | | |
| BCX 68-25 | CD | Q62702-C1866 | | | | |

Maximum Ratings

| Parameter | Symbol | Values | Unit |
|--|-----------|----------------|------|
| Collector-emitter voltage | V_{CE0} | 20 | V |
| Collector-base voltage | V_{CB0} | 25 | |
| Emitter-base voltage | V_{EB0} | 5 | |
| Collector current | I_C | 1 | A |
| Peak collector current | I_{CM} | 2 | |
| Base current | I_B | 100 | mA |
| Peak base current | I_{BM} | 200 | |
| Total power dissipation, $T_s = 130\text{ °C}$ | P_{tot} | 1 | W |
| Junction temperature | T_j | 150 | °C |
| Storage temperature range | T_{stg} | – 65 ... + 150 | |

Thermal Resistance

| | | | |
|----------------------------------|--------------|------|-----|
| Junction - ambient ²⁾ | $R_{th\ JA}$ | ≤ 75 | K/W |
| Junction - soldering point | $R_{th\ JS}$ | ≤ 20 | |

¹⁾ For detailed information see chapter Package Outlines.

²⁾ Package mounted on epoxy pcb 40 mm × 40 mm × 1.5 mm/6 cm² Cu.

Electrical Characteristics

at $T_A = 25\text{ }^\circ\text{C}$, unless otherwise specified.

| Parameter | Symbol | Values | | | Unit |
|-----------|--------|--------|------|------|------|
| | | min. | typ. | max. | |

DC characteristics

| | | | | | |
|--|---------------|-----|-----|-----|---------------------|
| Collector-emitter breakdown voltage $I_C = 30\text{ mA}$ | $V_{(BR)CE0}$ | 20 | – | – | V |
| Collector-base breakdown voltage $I_C = 10\text{ }\mu\text{A}$ | $V_{(BR)CB0}$ | 25 | – | – | |
| Emitter-base breakdown voltage $I_E = 1\text{ }\mu\text{A}$ | $V_{(BR)EB0}$ | 5 | – | – | |
| Collector cutoff current $V_{CB} = 25\text{ V}$ $V_{CB} = 25\text{ V}, T_A = 150\text{ }^\circ\text{C}$ | I_{CB0} | – | – | 100 | nA μA |
| Emitter cutoff current $V_{EB} = 5\text{ V}$ | I_{EB0} | – | – | 10 | μA |
| DC current gain ¹⁾ $I_C = 5\text{ mA}, V_{CE} = 10\text{ V}$ $I_C = 500\text{ mA}, V_{CE} = 1\text{ V}$ | h_{FE} | 50 | – | – | – |
| | | 85 | – | 375 | |
| | | 85 | 100 | 160 | |
| | | 100 | 160 | 250 | |
| | | 160 | 250 | 375 | |
| $I_C = 1\text{ A}, V_{CE} = 1\text{ V}$ | | 60 | – | – | |
| Collector-emitter saturation voltage ¹⁾ $I_C = 1\text{ A}, I_B = 100\text{ mA}$ | V_{CEsat} | – | – | 0.5 | V |
| Base-emitter voltage ¹⁾ $I_C = 5\text{ mA}, V_{CE} = 10\text{ V}$ $I_C = 1\text{ A}, V_{CE} = 1\text{ V}$ | V_{BE} | – | 0.6 | – | |
| | | – | – | 1 | |

AC characteristics

| | | | | | |
|---|-------|---|-----|---|-----|
| Transition frequency $I_C = 100\text{ mA}, V_{CE} = 5\text{ V}, f = 20\text{ MHz}$ | f_T | – | 100 | – | MHz |
|---|-------|---|-----|---|-----|

¹⁾ Pulse test: $t \leq 300\text{ }\mu\text{s}, D = 2\text{ }%$.

Total power dissipation $P_{tot} = f(T_A^*; T_S)$

* Package mounted on epoxy

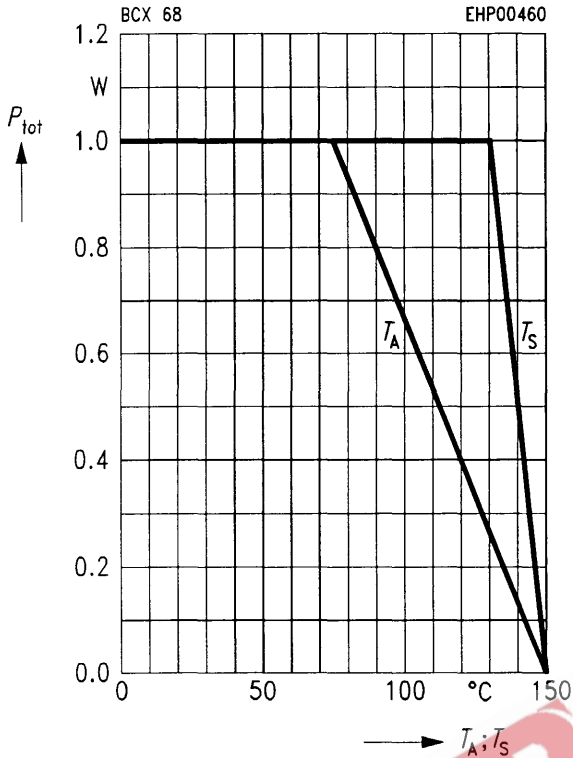

Collector current $I_C = f(V_{BE})$

$V_{CE} = 1 V$

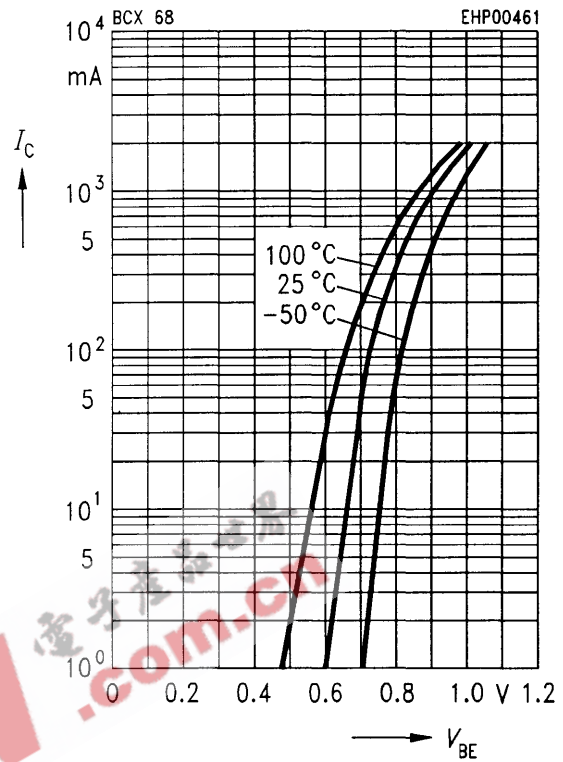

Permissible pulse load $P_{tot max}/P_{tot DC} = f(t_p)$

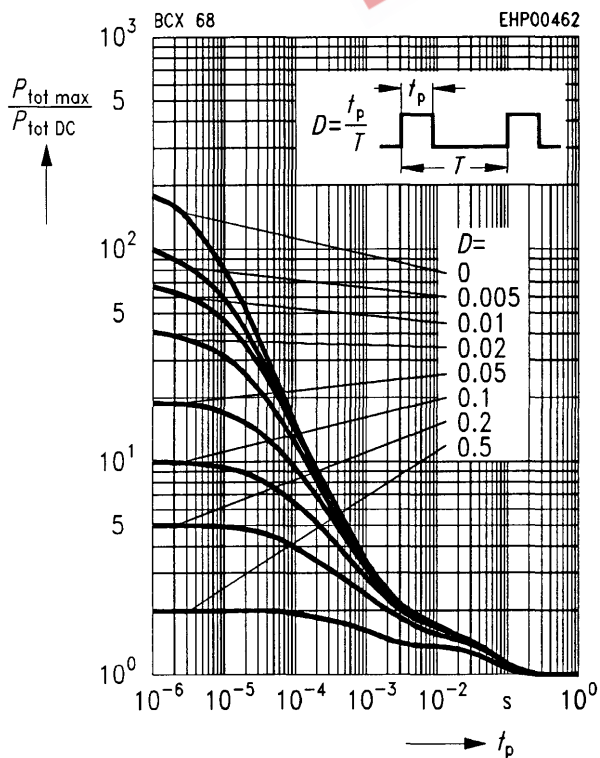

Transition frequency $f_T = f(I_C)$

$V_{CE} = 5 V$

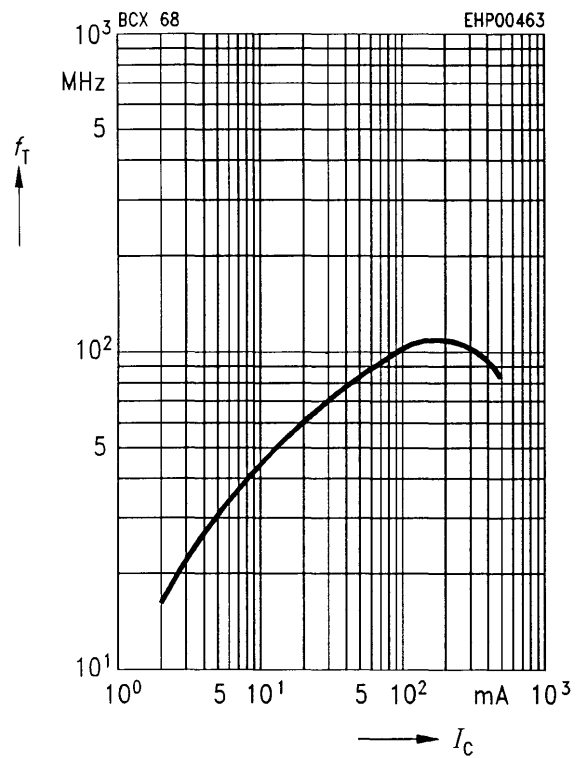

DC current gain $h_{FE} = f(I_C)$

$V_{CE} = 1 \text{ V}$

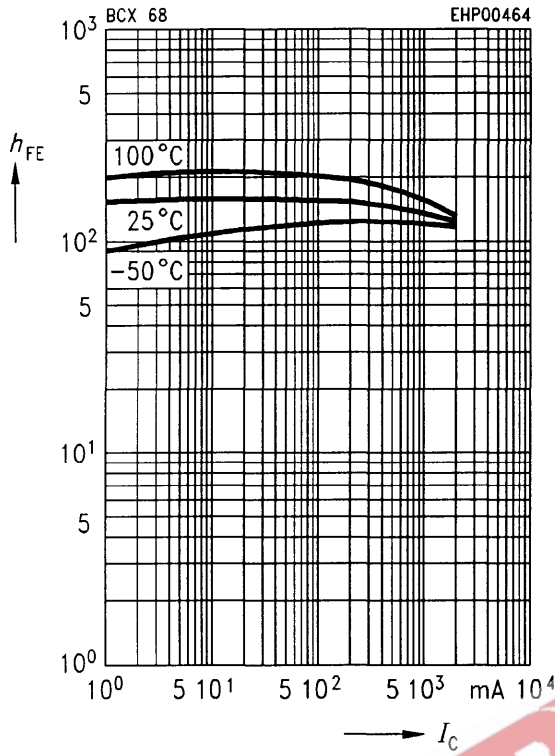

Collector-emitter saturation voltage $I_C = f(V_{CEsat})$

$I_C = f(V_{CEsat})$

$h_{FE} = 10$

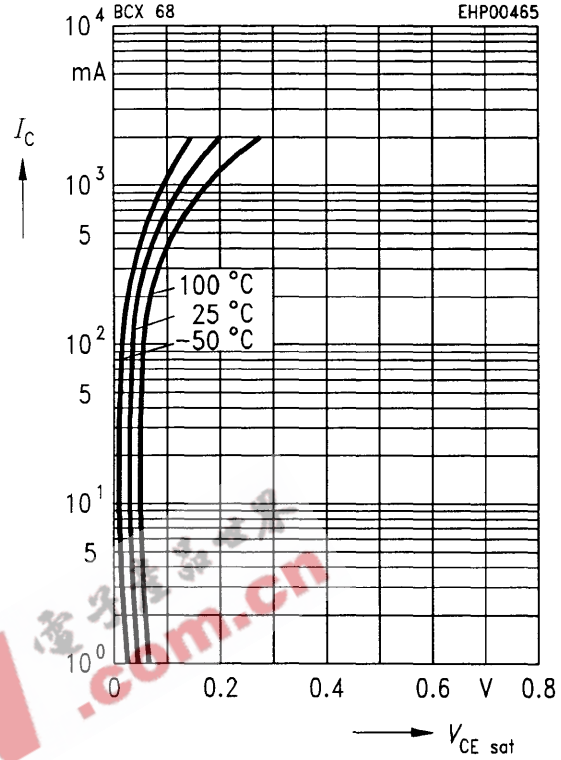

Collector cutoff current $I_{CBO} = f(T_A)$

$V_{CB} = 25 \text{ V}$

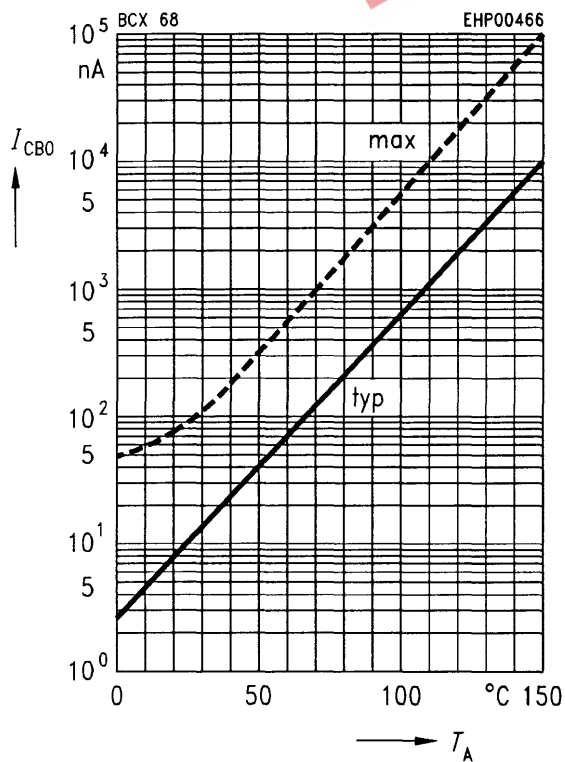

Base-emitter saturation voltage $I_C = f(V_{BEsat})$

$I_C = f(V_{BEsat})$

$h_{FE} = 10$

