

PNP Silicon AF Transistors

BCX 78
BCX 79

- High current gain
- Low collector-emitter saturation voltage
- Low noise at 1 kHz
- Low noise at low frequencies
- Complementary types: BCX 58, BCX 59 (NPN)

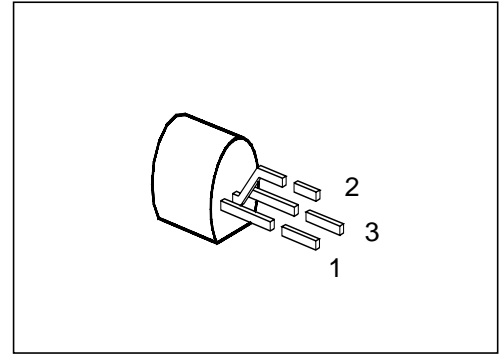

Type	Marking	Ordering Code	Pin Configuration			Package ¹⁾
			1	2	3	
BCX 78	—	Q62702-C717	C	B	E	TO-92
BCX 78-VII		Q62702-C626				
BCX 78-VIII		Q62702-C627				
BCX 78-IX		Q62702-C628				
BCX 78-X		Q62702-C629				
BCX 79		Q62702-C718				
BCX 79-VII		Q62702-C630				
BCX 79-VIII		Q62702-C631				
BCX 79-IX		Q62702-C632				
BCX 79-X		Q62702-C633				

¹⁾ For detailed information see chapter Package Outlines.

Maximum Ratings

Parameter	Symbol	Values		Unit
		BCX 78	BCX 79	
Collector-emitter voltage	V_{CE0}	32	45	V
Collector-base voltage	V_{CB0}	32	45	
Emitter-base voltage	V_{EB0}	5		
Collector current	I_C	100		mA
Peak collector current	I_{CM}	200		
Peak base current	I_{BM}	200		
Total power dissipation, $T_C = 70\text{ °C}$	P_{tot}	500		mW
Junction temperature	T_j	150		°C
Storage temperature range	T_{stg}	- 65 ... + 150		

Thermal Resistance

Junction - ambient	$R_{th JA}$	≤ 250	K/W
Junction - case ¹⁾	$R_{th JC}$	≤ 160	

¹⁾ Mounted on Al heat sink 15 mm × 25 mm × 0.5 mm.

Electrical Characteristics

at $T_A = 25\text{ }^\circ\text{C}$, unless otherwise specified.

Parameter	Symbol	Values			Unit
		min.	typ.	max.	
DC characteristics					
Collector-emitter breakdown voltage $I_C = 2\text{ mA}$	$V_{(BR)CE0}$				V
BCX 78		32	—	—	
BCX 79		45	—	—	
Collector-base breakdown voltage $I_C = 10\text{ }\mu\text{A}$	$V_{(BR)CB0}$				
BCX 78		32	—	—	
BCX 79		45	—	—	
Emitter-base breakdown voltage $I_E = 1\text{ }\mu\text{A}$	$V_{(BR)EB0}$	5	—	—	
Collector cutoff current $V_{CB} = 32\text{ V}$	I_{CB0}				nA
BCX 78		—	—	20	
$V_{CB} = 45\text{ V}$					nA
BCX 79		—	—	20	
$V_{CB} = 32\text{ V}, T_A = 150\text{ }^\circ\text{C}$					μA
BCX 78		—	—	10	
$V_{CB} = 45\text{ V}, T_A = 150\text{ }^\circ\text{C}$					μA
BCX 79		—	—	10	
Collector cutoff current $V_{CB} = 32\text{ V}, V_{BE} = 0.2\text{ V}, T_A = 100\text{ }^\circ\text{C}$	I_{CE0}				μA
BCX 78		—	—	20	
$V_{CB} = 45\text{ V}, V_{BE} = 0.2\text{ V}, T_A = 100\text{ }^\circ\text{C}$					μA
BCX 79		—	—	20	
Emitter cutoff current $V_{EB} = 4\text{ V}$	I_{EB0}	—	—	20	nA
DC current gain $I_C = 10\text{ }\mu\text{A}, V_{CE} = 5\text{ V}$	h_{FE}				—
BCX 78 VII, BCX 79 VII		20	140	—	
BCX 78 VIII, BCX 79 VIII		30	200	—	
BCX 78 IX, BCX 79 IX		40	270	—	
BCX 78 X, BCX 79 X		100	340	—	
$I_C = 2\text{ mA}, V_{CE} = 5\text{ V}$					
BCX 78 VII, BCX 79 VII		120	170	220	
BCX 78 VIII, BCX 79 VIII		180	250	310	
BCX 78 IX, BCX 79 IX		250	350	460	
BCX 78 X, BCX 79 X		380	500	630	
$I_C = 100\text{ mA}, V_{CE} = 1\text{ V}^{1)}$					
BCX 78 VII, BCX 79 VII		40	—	—	
BCX 78 VIII, BCX 79 VIII		45	—	—	
BCX 78 IX, BCX 79 IX		60	—	—	
BCX 78 X, BCX 79 X		60	—	—	

¹⁾ Pulse test: $t \leq 300\text{ }\mu\text{s}, D \leq 2\%$.

Electrical Characteristics

at $T_A = 25\text{ °C}$, unless otherwise specified.

Parameter	Symbol	Values			Unit
		min.	typ.	max.	

DC characteristics

Collector-emitter saturation voltage ¹⁾ $I_C = 100\text{ mA}$, $I_B = 2.5\text{ mA}$	V_{CEsat}	–	–	0.6	V
Base-emitter saturation voltage ¹⁾ $I_C = 100\text{ mA}$, $I_B = 2.5\text{ mA}$	V_{BEsat}	–	–	1.0	
Base-emitter voltage $I_C = 10\text{ }\mu\text{A}$, $V_{CE} = 5\text{ V}$ $I_C = 2\text{ mA}$, $V_{CE} = 5\text{ V}$ $I_C = 100\text{ mA}$, $V_{CE} = 1\text{ V}$ ¹⁾	$V_{BE(on)}$	– 0.55 –	0.52 0.65 0.93	– 0.75 –	

EEPW.com.cn 电子产品世界

¹⁾ Pulse test: $t \leq 300\text{ }\mu\text{s}$, $D \leq 2\%$.

Electrical Characteristics

at $T_A = 25\text{ }^\circ\text{C}$, unless otherwise specified.

Parameter	Symbol	Values			Unit
		min.	typ.	max.	

AC characteristics

Transition frequency $I_C = 20\text{ mA}$, $V_{CE} = 5\text{ V}$, $f = 100\text{ MHz}$	f_t	–	250	–	MHz
Output capacitance $V_{CB} = 10\text{ V}$, $f = 1\text{ MHz}$	C_{obo}	–	3	–	pF
Input capacitance $V_{EB} = 0.5\text{ V}$, $f = 1\text{ MHz}$	C_{ibo}	–	10	–	
Short-circuit input impedance $I_C = 2\text{ mA}$, $V_{CE} = 5\text{ V}$, $f = 1\text{ kHz}$ BCX 78 VII, BCX 79 VII BCX 78 VIII, BCX 79 VIII BCX 78 IX, BCX 79 IX BCX 78 X, BCX 79 X	h_{11e}	–	2.7 3.6 4.5 7.5	–	k Ω
Open-circuit reverse voltage transfer ratio $I_C = 2\text{ mA}$, $V_{CE} = 5\text{ V}$, $f = 1\text{ kHz}$ BCX 78 VII, BCX 79 VII BCX 78 VIII, BCX 79 VIII BCX 78 IX, BCX 79 IX BCX 78 X, BCX 79 X	h_{12e}	–	1.5 2 2 3	–	10^{-4}
Short-circuit forward current transfer ratio $I_C = 2\text{ mA}$, $V_{CE} = 5\text{ V}$, $f = 1\text{ kHz}$ BCX 78 VII, BCX 79 VII BCX 78 VIII, BCX 79 VIII BCX 78 IX, BCX 79 IX BCX 78 X, BCX 79 X	h_{21e}	–	200 260 330 520	–	–
Open-circuit output admittance $I_C = 2\text{ mA}$, $V_{CE} = 5\text{ V}$, $f = 1\text{ kHz}$ BCX 78 VII, BCX 79 VII BCX 78 VIII, BCX 79 VIII BCX 78 IX, BCX 79 IX BCX 78 X, BCX 79 X	h_{22e}	–	18 24 30 50	–	μS
Noise figure $I_C = 0.2\text{ mA}$, $V_{CE} = 5\text{ V}$, $R_S = 2\text{ k}\Omega$ $f = 1\text{ kHz}$, $\Delta f = 200\text{ Hz}$	F	–	2	–	dB

Total power dissipation $P_{tot} = f(T_A; T_C)$

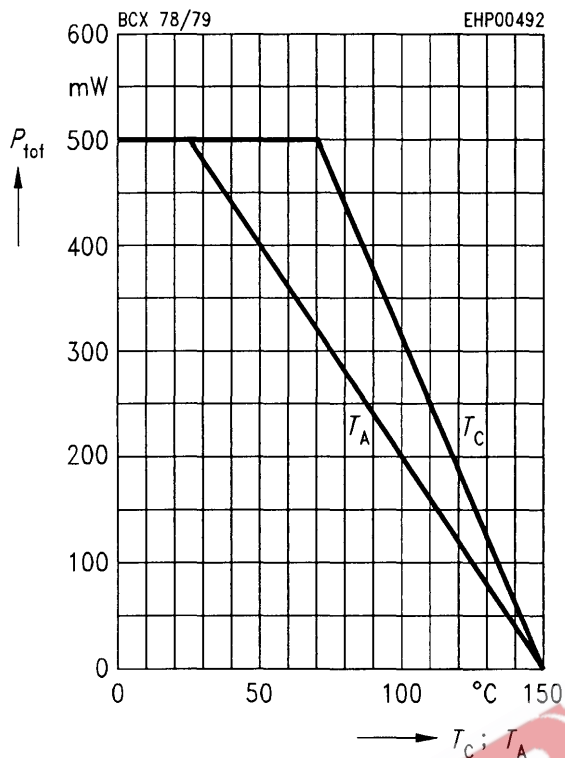

**Collector current $I_C = f(V_{BE})$
 $V_{CE} = 5 V$**

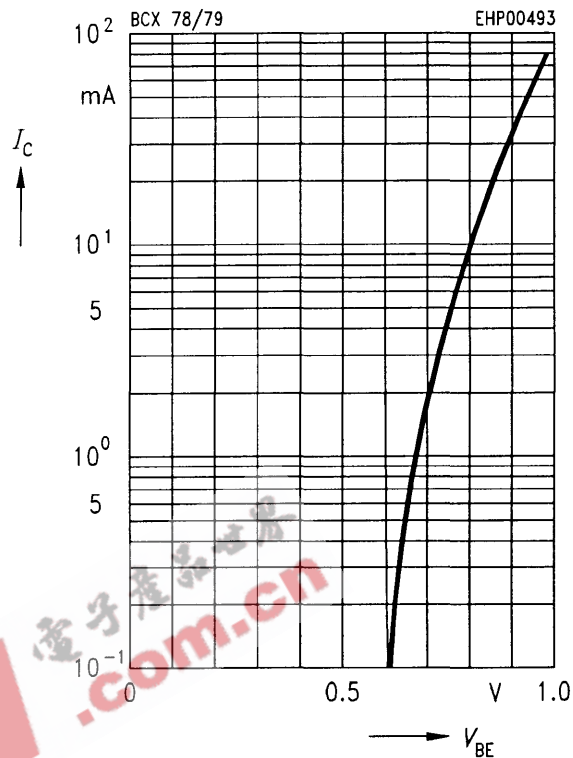

Permissible pulse load $R_{thJA} = f(t_p)$

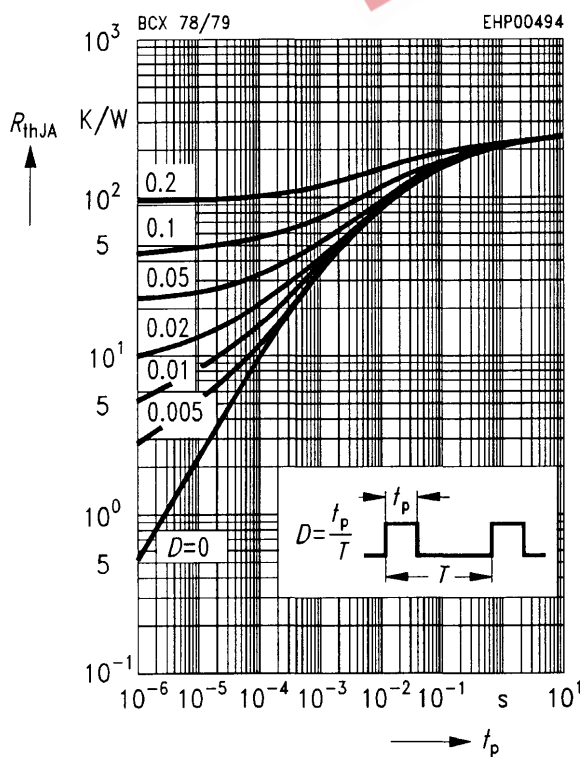

**Collector cutoff current $I_{CB0} = f(T_A)$
for max. permissible reverse voltage**

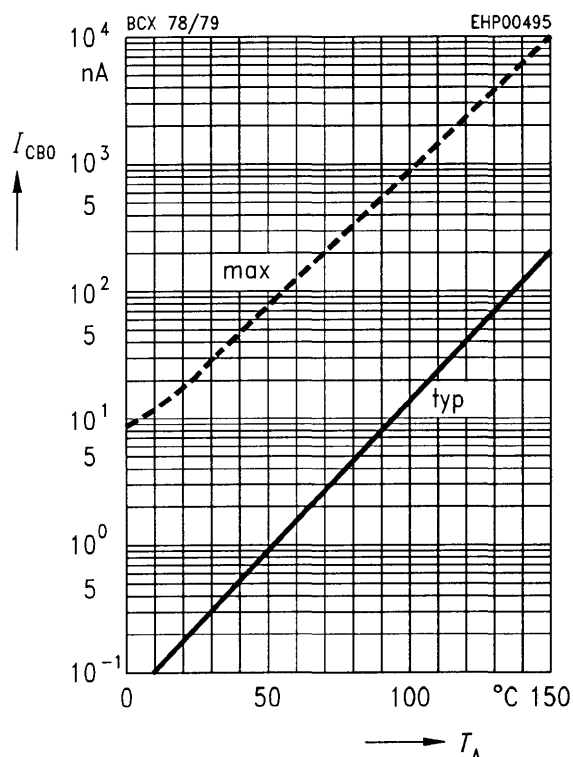

DC current gain $h_{FE} = f(I_C)$
 $V_{CE} = 5\text{ V}$ (common emitter configuration)

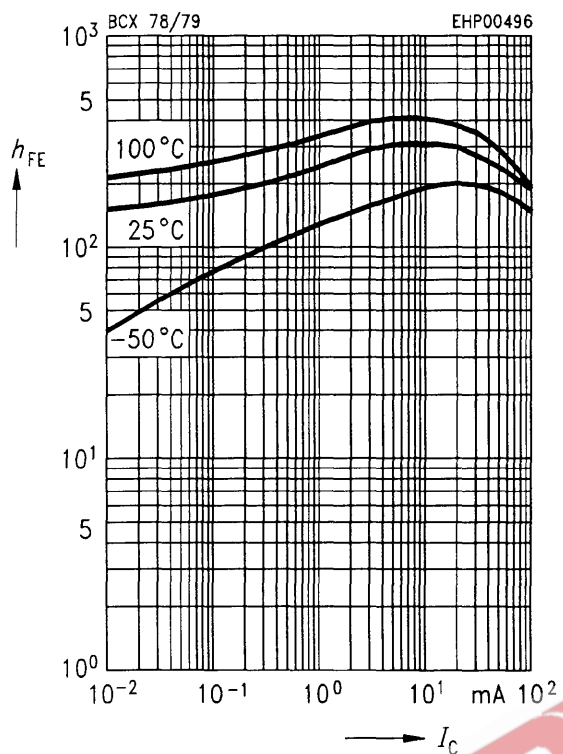

Transition frequency $f_T = f(I_C)$
 $V_{CE} = 5\text{ V}$

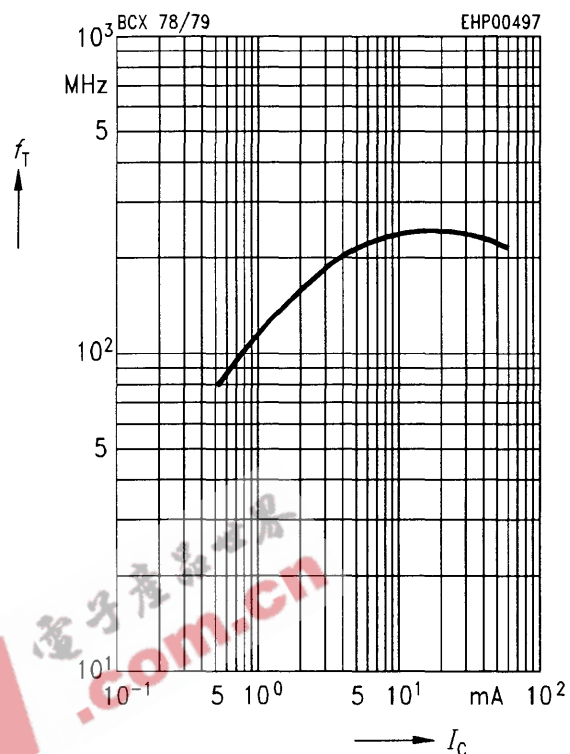

Collector-emitter saturation voltage

$I_C = f(V_{CEsat})$
 $h_{FE} = 20$

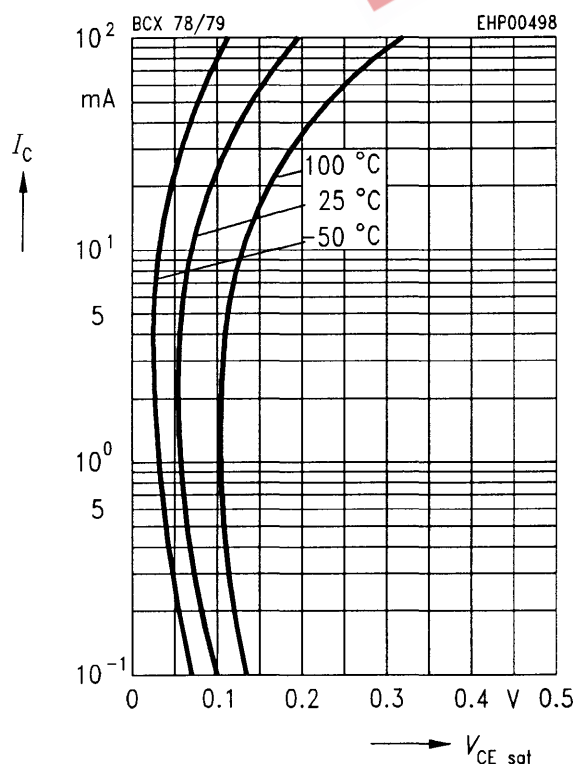

Base-emitter saturation voltage

$I_C = f(V_{BEsat})$
 $h_{FE} = 20$

