

Darlington Complementary Silicon Power Transistors

... designed for general purpose and low speed switching applications.

- High DC Current Gain — $h_{FE} = 2500$ (typ.) at $I_C = 4.0$
- Collector–Emitter Sustaining Voltage at 100 mAdc
 $V_{CEO(sus)} = 80$ Vdc (min.) — BDX33B, 34B
 100 Vdc (min.) — BDX33C, 34C
- Low Collector–Emitter Saturation Voltage
 $V_{CE(sat)} = 2.5$ Vdc (max.) at $I_C = 3.0$ Adc — BDX33B, 33C/34B, 34C
- Monolithic Construction with Build–In Base–Emitter Shunt resistors
- TO–220AB Compact Package

MAXIMUM RATINGS

Rating	Symbol	BDX33B BDX34B	BDX33C BDX34C	Unit
Collector–Emitter Voltage	V_{CEO}	80	100	Vdc
Collector–Base Voltage	V_{CB}	80	100	Vdc
Emitter–Base Voltage	V_{EB}	5.0		Vdc
Collector Current — Continuous Peak	I_C	10 15		Adc
Base Current	I_B	0.25		Adc
Total Device Dissipation @ $T_C = 25^\circ\text{C}$ Derate above 25°C	P_D	70 0.56		Watts W/ $^\circ\text{C}$
Operating and Storage Junction Temperature Range	T_J, T_{stg}	–65 to +150		$^\circ\text{C}$

THERMAL CHARACTERISTICS

Characteristic	Symbol	Max	Unit
Thermal Resistance, Junction to Case	$R_{\theta JC}$	1.78	$^\circ\text{C}/\text{W}$

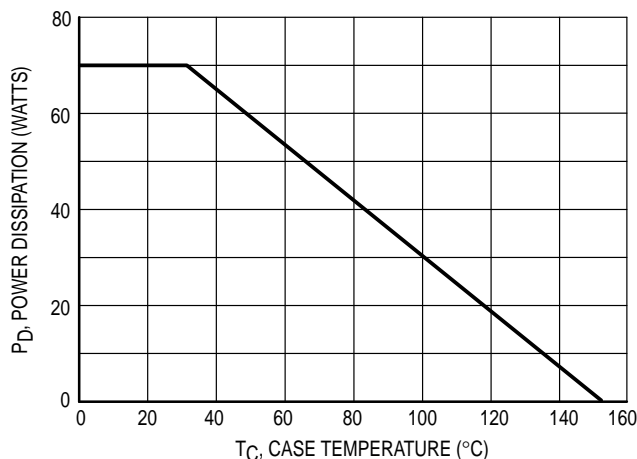

Figure 1. Power Derating

Preferred devices are Motorola recommended choices for future use and best overall value.

REV 7

NPN
BDX33B
BDX33C*
PNP
BDX34B
BDX34C*

*Motorola Preferred Device

DARLINGTON
10 AMPERE
COMPLEMENTARY
SILICON
POWER TRANSISTORS
80–100 VOLTS
70 WATTS

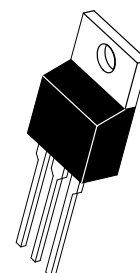

CASE 221A–06
TO–220AB

BDX33B BDX33C BDX34B BDX34C

ELECTRICAL CHARACTERISTICS ($T_C = 25^\circ\text{C}$ unless otherwise noted)

Characteristic		Symbol	Min	Max	Unit
OFF CHARACTERISTICS					
Collector–Emitter Sustaining Voltage ¹ ($I_C = 100\text{ mAdc}$, $I_B = 0$)	BDX33B/BDX34B BDX33C/BDX34C	$V_{CEO(sus)}$	80 100	— —	Vdc
Collector–Emitter Sustaining Voltage ¹ ($I_C = 100\text{ mAdc}$, $I_B = 0$, $R_{BE} = 100$)	BDX33B/BDX34B BDX33C/BDX33C	$V_{CER(sus)}$	80 100	— —	Vdc
Collector–Emitter Sustaining Voltage ¹ ($I_C = 100\text{ mAdc}$, $I_B = 0$, $V_{BE} = 1.5\text{ Vdc}$)	BDX33B/BDX34B BDX33C/BDX34C	$V_{CEX(sus)}$	80 100	— —	Vdc
Collector Cutoff Current ($V_{CE} = 1/2$ rated V_{CEO} , $I_B = 0$)	$T_C = 25^\circ\text{C}$ $T_C = 100^\circ\text{C}$	I_{CEO}	— —	0.5 10	mAdc
Collector Cutoff Current ($V_{CB} =$ rated V_{CBO} , $I_E = 0$)	$T_C = 25^\circ\text{C}$ $T_C = 100^\circ\text{C}$	I_{CBO}	— —	1.0 5.0	mAdc
Emitter Cutoff Current ($V_{BE} = 5.0\text{ Vdc}$, $I_C = 0$)		I_{EBO}	—	10	mAdc
ON CHARACTERISTICS					
DC Current Gain ¹ ($I_C = 3.0\text{ Adc}$, $V_{CE} = 3.0\text{ Vdc}$)	BDX33B, 33C/34B, 34C	h_{FE}	750	—	—
Collector–Emitter Saturation Voltage ($I_C = 3.0\text{ Adc}$, $I_B = 6.0\text{ mAdc}$)	BDX33B, 33C/34B, 34C	$V_{CE(sat)}$	—	2.5	Vdc
Base–Emitter On Voltage ($I_C = 3.0\text{ Adc}$, $V_{CE} = 3.0\text{ Vdc}$)	BDX33B, 33C/34B, 34C	$V_{BE(on)}$	—	2.5	Vdc
Diode Forward Voltage ($I_C = 8.0\text{ Adc}$)		V_F	—	4.0	Vdc

¹ Pulse Test: Pulse Width $\leq 300\ \mu\text{s}$, Duty Cycle $\leq 2.0\%$.

² Pulse Test non repetitive: Pulse Width = 0.25 s.

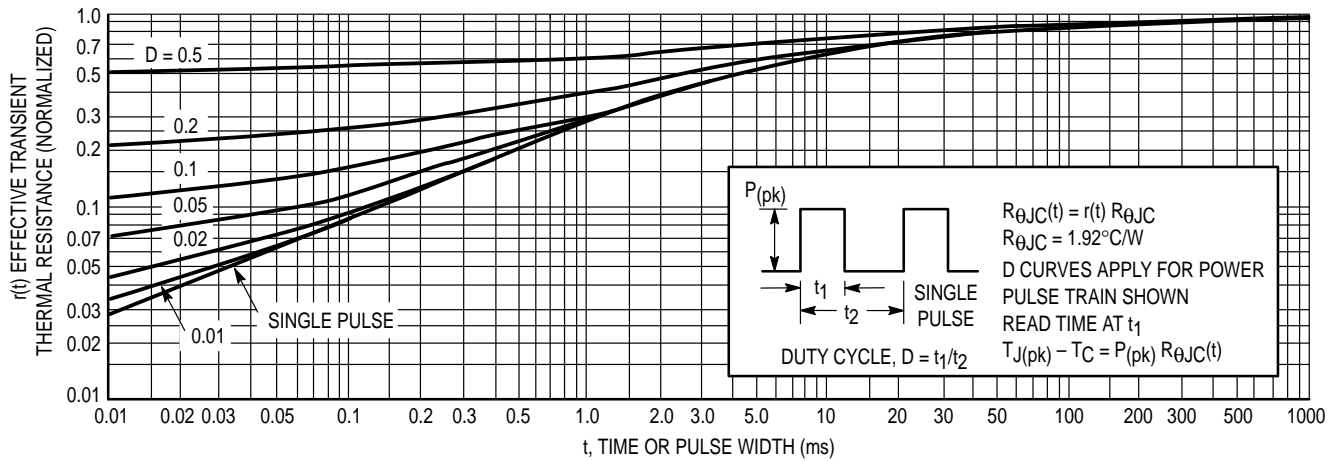

Figure 1. Thermal Response

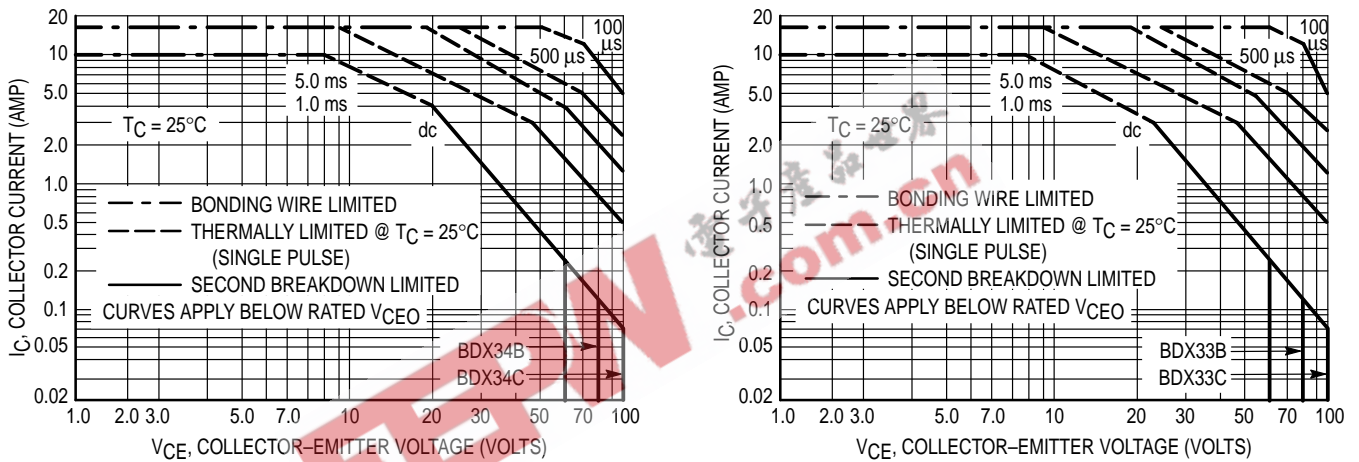

Figure 2. Active-Region Safe Operating Area

There are two limitations on the power handling ability of a transistor: average junction temperature and second breakdown. Safe operating area curves indicate $I_C - V_{CE}$ limits of the transistor that must be observed for reliable operation, i.e., the transistor must not be subjected to greater dissipation than the curves indicate. The data of Fig. 3 is based on

$T_{J(pk)} = 150^\circ\text{C}$; T_C is variable depending on conditions. Second breakdown pulse limits are valid for duty cycles to 10% provided $T_{J(pk)} = 150^\circ\text{C}$. $T_{J(pk)}$ may be calculated from the data in Fig. . At high case temperatures, thermal limitations will reduce the power that can be handled to values less than the limitations imposed by second breakdown.

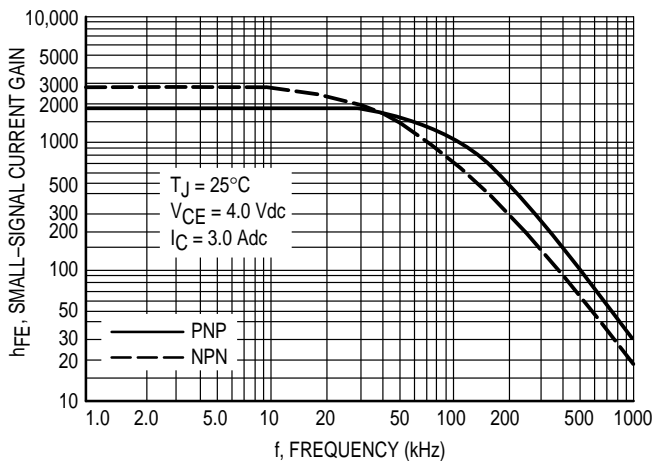

Figure 3. Small-Signal Current Gain

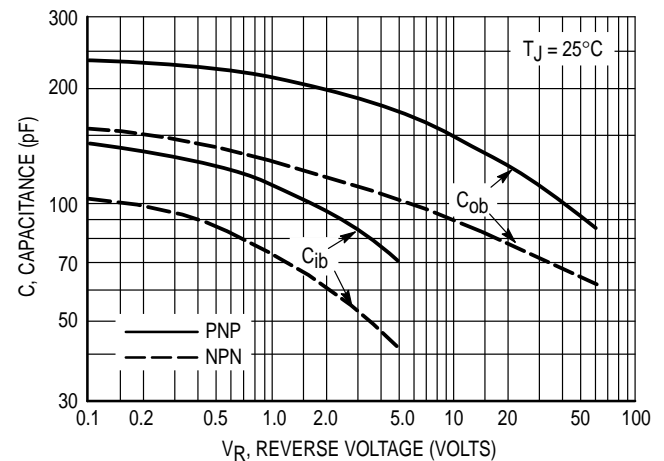

Figure 4. Capacitance

BDX33B BDX33C BDX34B BDX34C

**NPN
BDX33B, 33C**

**PNP
BDX34B, 34C**

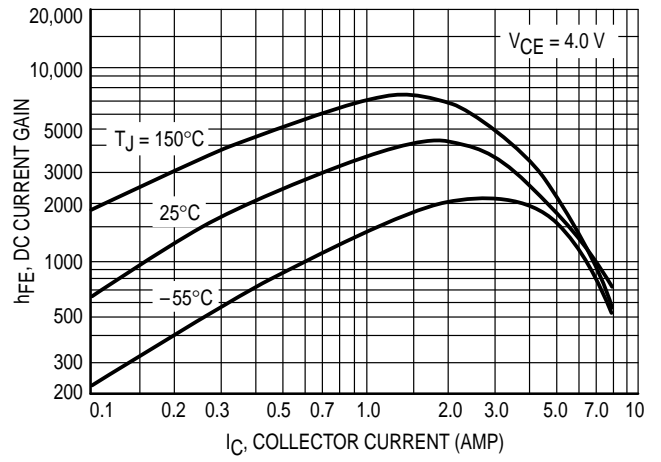
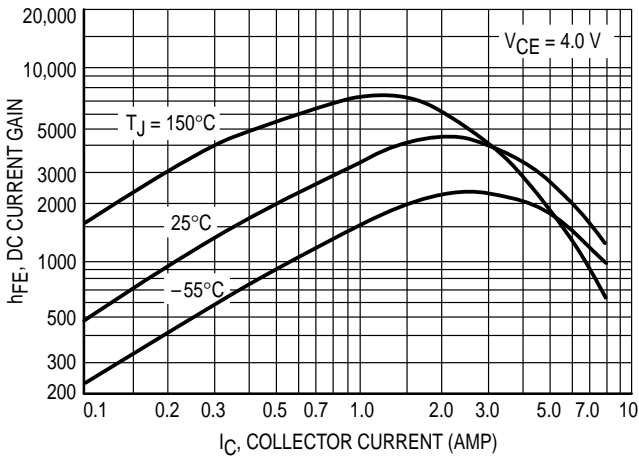

Figure 5. DC Current Gain

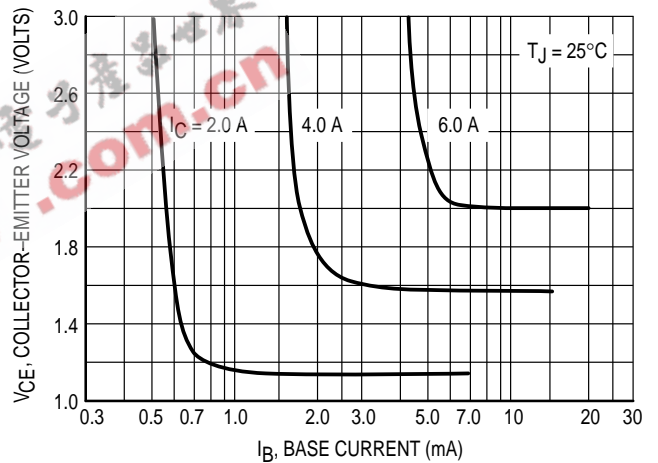
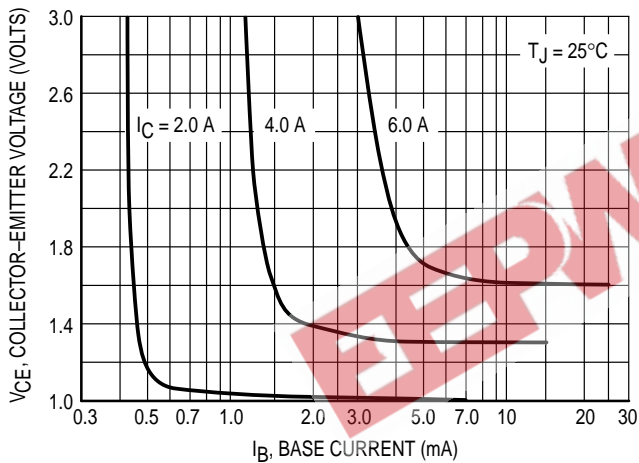

Figure 6. Collector Saturation Region

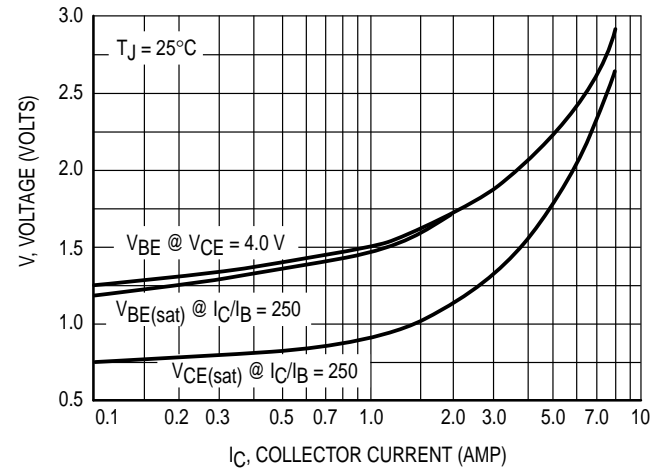
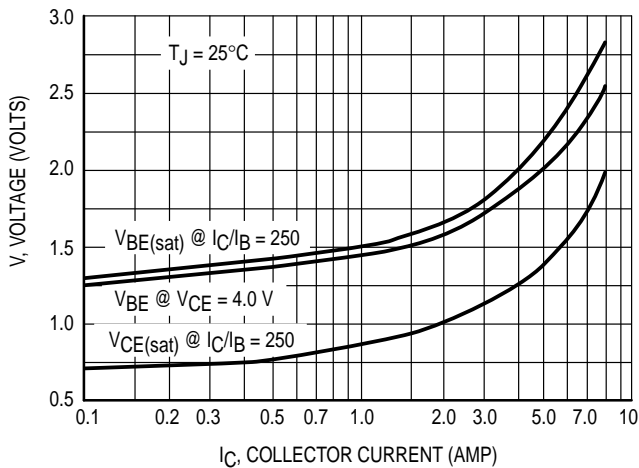
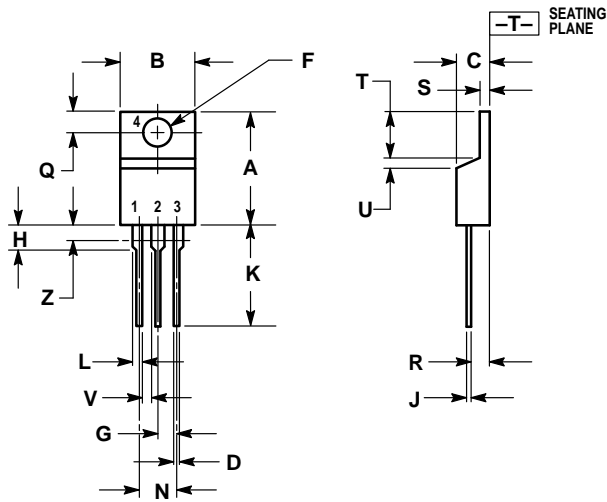

Figure 7. "On" Voltages

BDX33B BDX33C BDX34B BDX34C

PACKAGE DIMENSIONS



- NOTES:
1. DIMENSIONING AND TOLERANCING PER ANSI Y14.5M, 1982.
 2. CONTROLLING DIMENSION: INCH.
 3. DIMENSION Z DEFINES A ZONE WHERE ALL BODY AND LEAD IRREGULARITIES ARE ALLOWED.

DIM	INCHES		MILLIMETERS	
	MIN	MAX	MIN	MAX
A	0.570	0.620	14.48	15.75
B	0.380	0.405	9.66	10.28
C	0.160	0.190	4.07	4.82
D	0.025	0.035	0.64	0.88
F	0.142	0.147	3.61	3.73
G	0.095	0.105	2.42	2.66
H	0.110	0.155	2.80	3.93
J	0.018	0.025	0.46	0.64
K	0.500	0.562	12.70	14.27
L	0.045	0.060	1.15	1.52
N	0.190	0.210	4.83	5.33
Q	0.100	0.120	2.54	3.04
R	0.080	0.110	2.04	2.79
S	0.045	0.055	1.15	1.39
T	0.235	0.255	5.97	6.47
U	0.000	0.050	0.00	1.27
V	0.045	—	1.15	—
Z	—	0.080	—	2.04

- STYLE 1:
 PIN 1. BASE
 2. COLLECTOR
 3. EMITTER
 4. COLLECTOR

EPW.com.cn 电子产品世界

**CASE 221A-06
 TO-220AB
 ISSUE Y**

BDX33B BDX33C BDX34B BDX34C

EEPW 电子产品世界 .com.cn

Motorola reserves the right to make changes without further notice to any products herein. Motorola makes no warranty, representation or guarantee regarding the suitability of its products for any particular purpose, nor does Motorola assume any liability arising out of the application or use of any product or circuit, and specifically disclaims any and all liability, including without limitation consequential or incidental damages. "Typical" parameters can and do vary in different applications. All operating parameters, including "Typicals" must be validated for each customer application by customer's technical experts. Motorola does not convey any license under its patent rights nor the rights of others. Motorola products are not designed, intended, or authorized for use as components in systems intended for surgical implant into the body, or other applications intended to support or sustain life, or for any other application in which the failure of the Motorola product could create a situation where personal injury or death may occur. Should Buyer purchase or use Motorola products for any such unintended or unauthorized application, Buyer shall indemnify and hold Motorola and its officers, employees, subsidiaries, affiliates, and distributors harmless against all claims, costs, damages, and expenses, and reasonable attorney fees arising out of, directly or indirectly, any claim of personal injury or death associated with such unintended or unauthorized use, even if such claim alleges that Motorola was negligent regarding the design or manufacture of the part. Motorola and  are registered trademarks of Motorola, Inc. Motorola, Inc. is an Equal Opportunity/Affirmative Action Employer.

How to reach us:

USA / EUROPE: Motorola Literature Distribution;
P.O. Box 20912; Phoenix, Arizona 85036. 1-800-441-2447

JAPAN: Nippon Motorola Ltd.; Tatsumi-SPD-JLDC, Toshikatsu Otsuki,
6F Seibu-Butsuryu-Center, 3-14-2 Tatsumi Koto-Ku, Tokyo 135, Japan. 03-3521-8315

MFAX: RMFAX0@email.sps.mot.com – TOUCHTONE (602) 244-6609
INTERNET: <http://Design-NET.com>

HONG KONG: Motorola Semiconductors H.K. Ltd.; 8B Tai Ping Industrial Park,
51 Ting Kok Road, Tai Po, N.T., Hong Kong. 852-26629298



BDX33B/D

