

# DATA SHEET

EEPW 电子产品世界  
.com.cn

## **BF1100; BF1100R** Dual-gate MOS-FETs

Product specification  
File under Discrete Semiconductors, SC07

1995 Apr 25

Philips Semiconductors



**PHILIPS**

# Dual-gate MOS-FETs

# BF1100; BF1100R

### FEATURES

- Specially designed for use at 9 to 12 V supply voltage
- Short channel transistor with high forward transfer admittance to input capacitance ratio
- Low noise gain controlled amplifier up to 1 GHz
- Superior cross-modulation performance during AGC.

### APPLICATIONS

- VHF and UHF applications such as television tuners and professional communications equipment.

### DESCRIPTION

Enhancement type field-effect transistor in a plastic microminiature SOT143 or SOT143R package. The transistor consists of an amplifier MOS-FET with source

and substrate interconnected and an internal bias circuit to ensure good cross-modulation performance during AGC.

### CAUTION

The device is supplied in an antistatic package. The gate-source input must be protected against static discharge during transport or handling.

### PINNING

PIN	SYMBOL	DESCRIPTION
1	s, b	source
2	d	drain
3	g <sub>2</sub>	gate 2
4	g <sub>1</sub>	gate 1

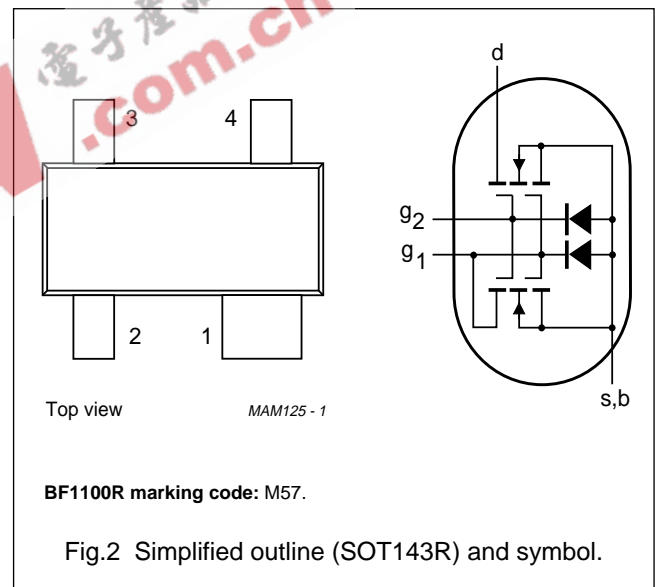
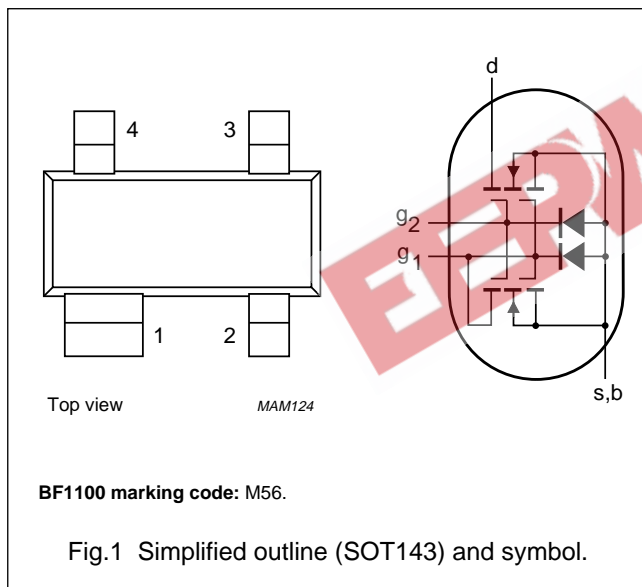

### QUICK REFERENCE DATA

SYMBOL	PARAMETER	CONDITIONS	MIN.	TYP.	MAX.	UNIT
V <sub>DS</sub>	drain-source voltage		–	–	14	V
I <sub>D</sub>	drain current		–	–	30	mA
P <sub>tot</sub>	total power dissipation		–	–	200	mW
T <sub>j</sub>	operating junction temperature		–	–	150	°C
y <sub>fs</sub>	forward transfer admittance		24	28	33	mS
C <sub>ig1-s</sub>	input capacitance at gate 1		–	2.2	2.6	pF
C <sub>rs</sub>	reverse transfer capacitance	f = 1 MHz	–	25	35	fF
F	noise figure	f = 800 MHz	–	2	–	dB

Dual-gate MOS-FETs

BF1100; BF1100R

**LIMITING VALUES**

In accordance with the Absolute Maximum Rating System (IEC 134).

SYMBOL	PARAMETER	CONDITIONS	MIN.	MAX.	UNIT
$V_{DS}$	drain-source voltage		–	14	V
$I_D$	drain current		–	30	mA
$I_{G1}$	gate 1 current		–	$\pm 10$	mA
$I_{G2}$	gate 2 current		–	$\pm 10$	mA
$P_{tot}$	total power dissipation BF1100 BF1100R	see Fig.3 up to $T_{amb} = 50\text{ }^\circ\text{C}$ ; note 1 up to $T_{amb} = 40\text{ }^\circ\text{C}$ ; note 1	–	200 200	mW mW
$T_{stg}$	storage temperature		–65	+150	$^\circ\text{C}$
$T_j$	operating junction temperature		–	+150	$^\circ\text{C}$

**Note**

1. Device mounted on a printed-circuit board.

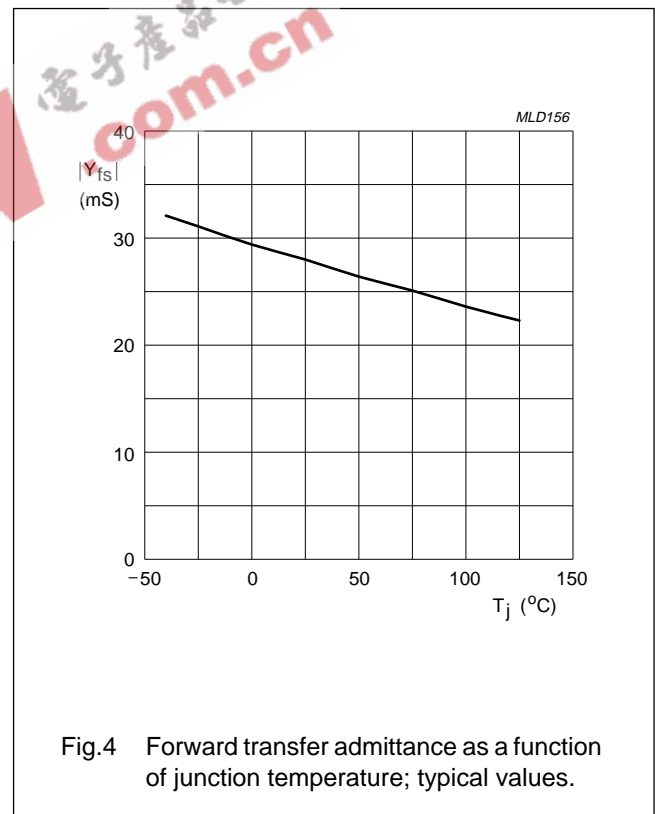
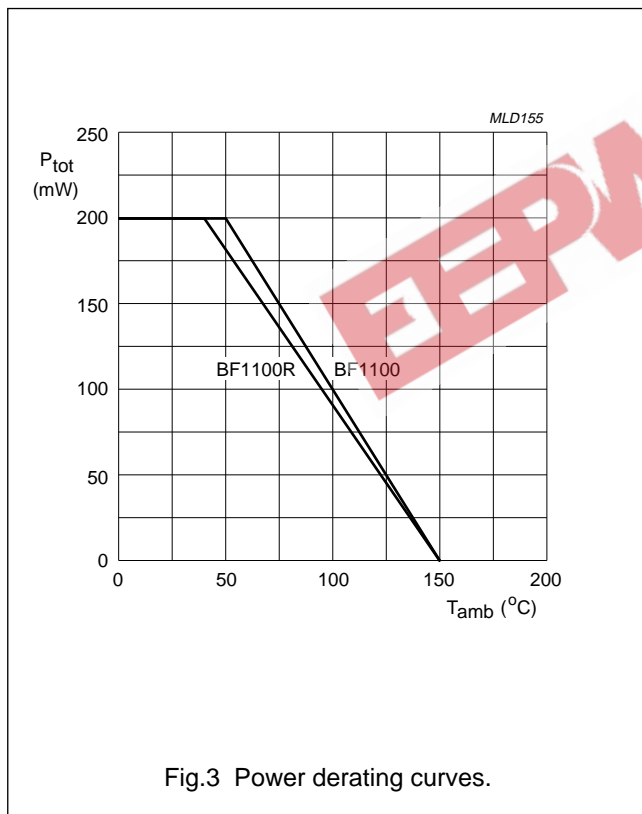

## Dual-gate MOS-FETs

## BF1100; BF1100R

## THERMAL CHARACTERISTICS

SYMBOL	PARAMETER	CONDITIONS	VALUE	UNIT
$R_{th\ j-a}$	thermal resistance from junction to ambient	note 1		
	BF1100		500	K/W
	BF1100R		550	K/W
$R_{th\ j-s}$	thermal resistance from junction to soldering point	note 2		
	BF1100	$T_s = 92\text{ °C}$	290	K/W
	BF1100R	$T_s = 78\text{ °C}$	360	K/W

## Notes

1. Device mounted on a printed-circuit board.
2.  $T_s$  is the temperature at the soldering point of the source lead.

## STATIC CHARACTERISTICS

$T_j = 25\text{ °C}$ ; unless otherwise specified.

SYMBOL	PARAMETER	CONDITIONS	MIN.	MAX.	UNIT
$V_{(BR)G1-SS}$	gate 1-source breakdown voltage	$V_{G2-S} = V_{DS} = 0$ ; $I_{G1-S} = 1\text{ mA}$	13.2	20	V
$V_{(BR)G2-SS}$	gate 2-source breakdown voltage	$V_{G1-S} = V_{DS} = 0$ ; $I_{G2-S} = 1\text{ mA}$	13.2	20	V
$V_{(F)S-G1}$	forward source-gate 1 voltage	$V_{G2-S} = V_{DS} = 0$ ; $I_{S-G1} = 10\text{ mA}$	0.5	1.5	V
$V_{(F)S-G2}$	forward source-gate 2 voltage	$V_{G1-S} = V_{DS} = 0$ ; $I_{S-G2} = 10\text{ mA}$	0.5	1.5	V
$V_{G1-S(th)}$	gate 1-source threshold voltage	$V_{G2-S} = 4\text{ V}$ ; $V_{DS} = 9\text{ V}$ ; $I_D = 20\text{ }\mu\text{A}$	0.3	1	V
		$V_{G2-S} = 4\text{ V}$ ; $V_{DS} = 12\text{ V}$ ; $I_D = 20\text{ }\mu\text{A}$	0.3	1	V
$V_{G2-S(th)}$	gate 2-source threshold voltage	$V_{G1-S} = 4\text{ V}$ ; $V_{DS} = 9\text{ V}$ ; $I_D = 20\text{ }\mu\text{A}$	0.3	1.2	V
		$V_{G1-S} = 4\text{ V}$ ; $V_{DS} = 12\text{ V}$ ; $I_D = 20\text{ }\mu\text{A}$	0.3	1.2	V
$I_{DSX}$	drain-source current	$V_{G2-S} = 4\text{ V}$ ; $V_{DS} = 9\text{ V}$ ; $R_{G1} = 180\text{ k}\Omega$ ; note 1	8	13	mA
		$V_{G2-S} = 4\text{ V}$ ; $V_{DS} = 12\text{ V}$ ; $R_{G1} = 250\text{ k}\Omega$ ; note 2	8	13	mA
$I_{G1-SS}$	gate 1 cut-off current	$V_{G2-S} = V_{DS} = 0$ ; $V_{G1-S} = 12\text{ V}$	–	50	nA
$I_{G2-SS}$	gate 2 cut-off current	$V_{G1-S} = V_{DS} = 0$ ; $V_{G2-S} = 12\text{ V}$	–	50	nA

## Notes

1.  $R_{G1}$  connects gate 1 to  $V_{GG} = 9\text{ V}$ ; see Fig.27.
2.  $R_{G1}$  connects gate 1 to  $V_{GG} = 12\text{ V}$ ; see Fig.27.

Dual-gate MOS-FETs

BF1100; BF1100R

DYNAMIC CHARACTERISTICS

Common source;  $T_{amb} = 25\text{ }^{\circ}\text{C}$ ;  $V_{G2-S} = 4\text{ V}$ ;  $I_D = 10\text{ mA}$ ; unless otherwise specified.

SYMBOL	PARAMETER	CONDITIONS	MIN.	TYP.	MAX.	UNIT
$ y_{fs} $	forward transfer admittance	pulsed; $T_j = 25\text{ }^{\circ}\text{C}$ $V_{DS} = 9\text{ V}$	24	28	33	mS
		$V_{DS} = 12\text{ V}$	24	28	33	mS
$C_{ig1-s}$	input capacitance at gate 1	$f = 1\text{ MHz}$ $V_{DS} = 9\text{ V}$	–	2.2	2.6	pF
		$V_{DS} = 12\text{ V}$	–	2.2	2.6	pF
$C_{ig2-s}$	input capacitance at gate 2	$f = 1\text{ MHz}$ $V_{DS} = 9\text{ V}$	–	1.6	–	pF
		$V_{DS} = 12\text{ V}$	–	1.4	–	pF
$C_{os}$	drain-source capacitance	$f = 1\text{ MHz}$ $V_{DS} = 9\text{ V}$	–	1.4	1.8	pF
		$V_{DS} = 12\text{ V}$	–	1.1	1.5	pF
$C_{rs}$	reverse transfer capacitance	$f = 1\text{ MHz}$ $V_{DS} = 9\text{ V}$	–	25	35	fF
		$V_{DS} = 12\text{ V}$	–	25	35	fF
F	noise figure	$f = 800\text{ MHz}$ ; $G_S = G_{Sopt}$ ; $B_S = B_{Sopt}$ $V_{DS} = 9\text{ V}$	–	2	2.8	dB
		$V_{DS} = 12\text{ V}$	–	2	2.8	dB

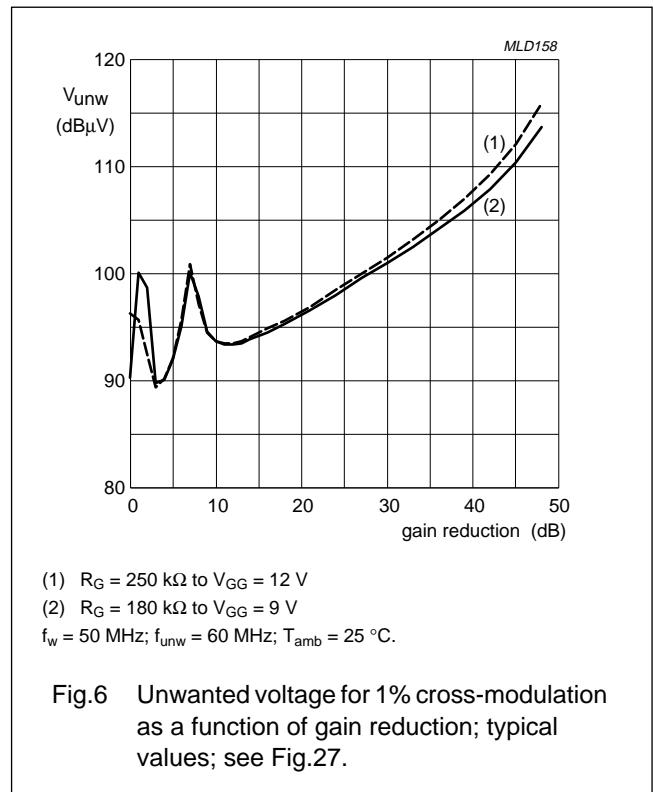
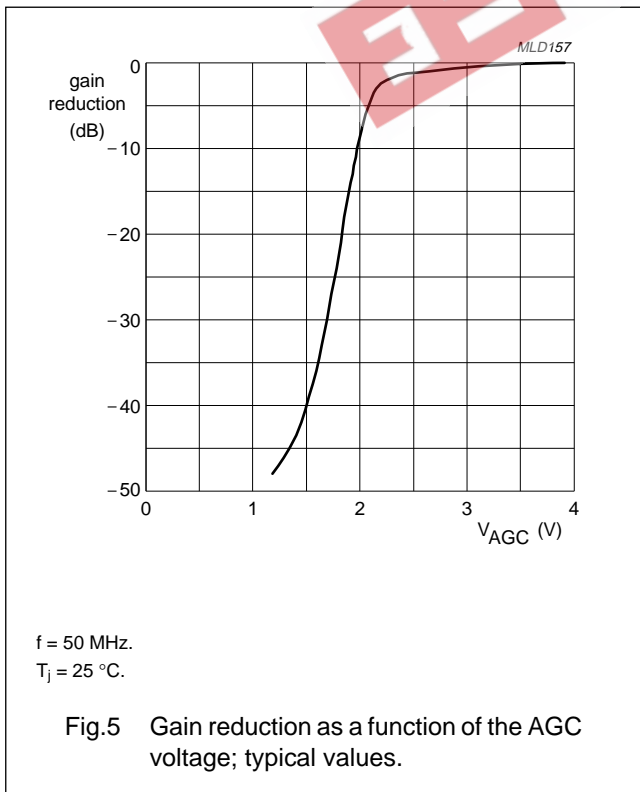

Dual-gate MOS-FETs

BF1100; BF1100R

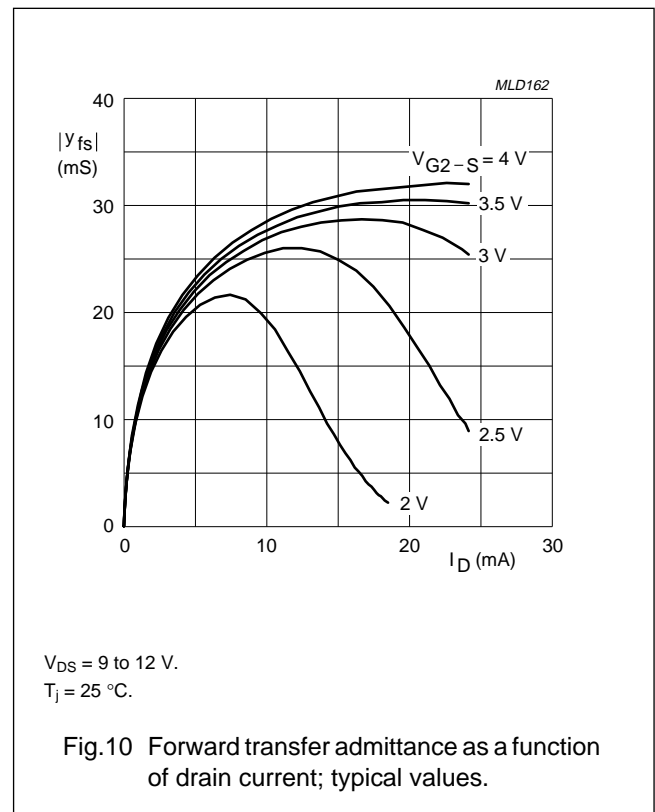
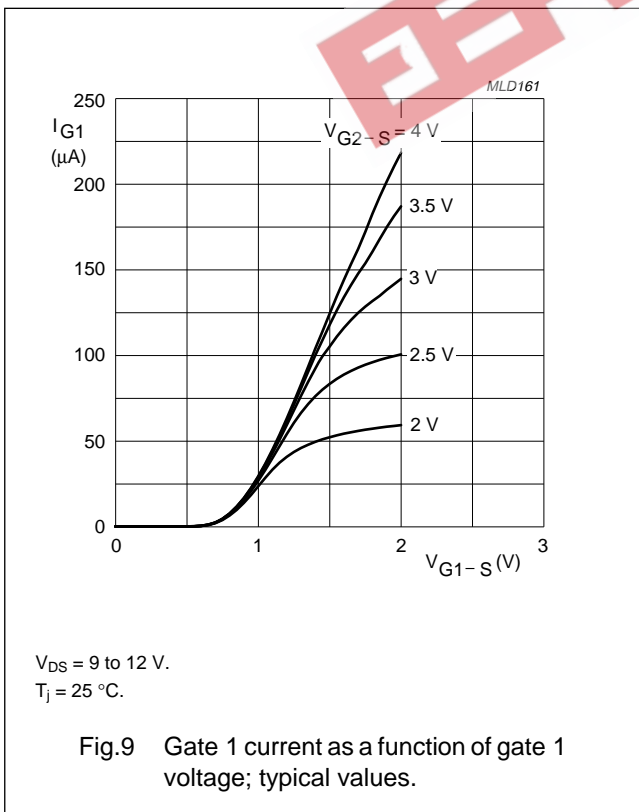
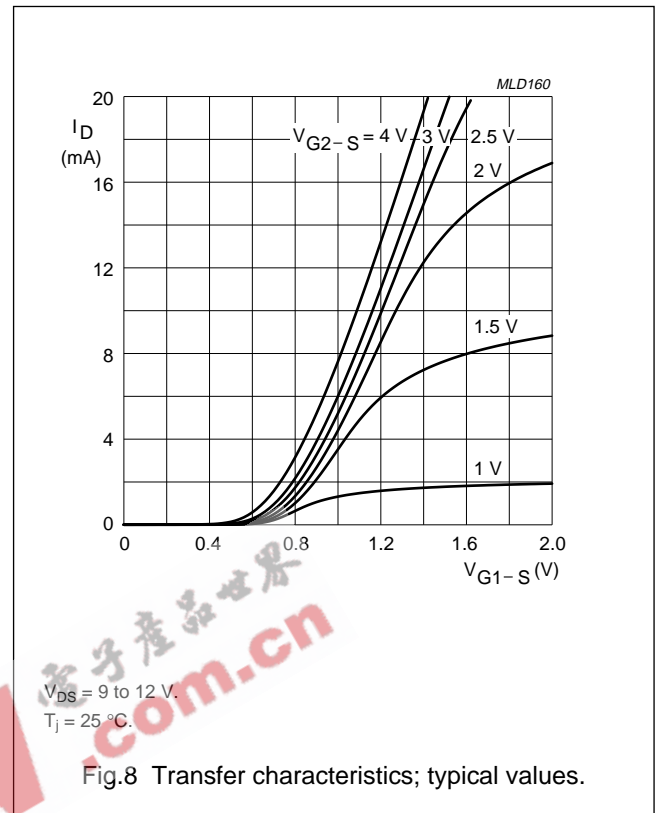
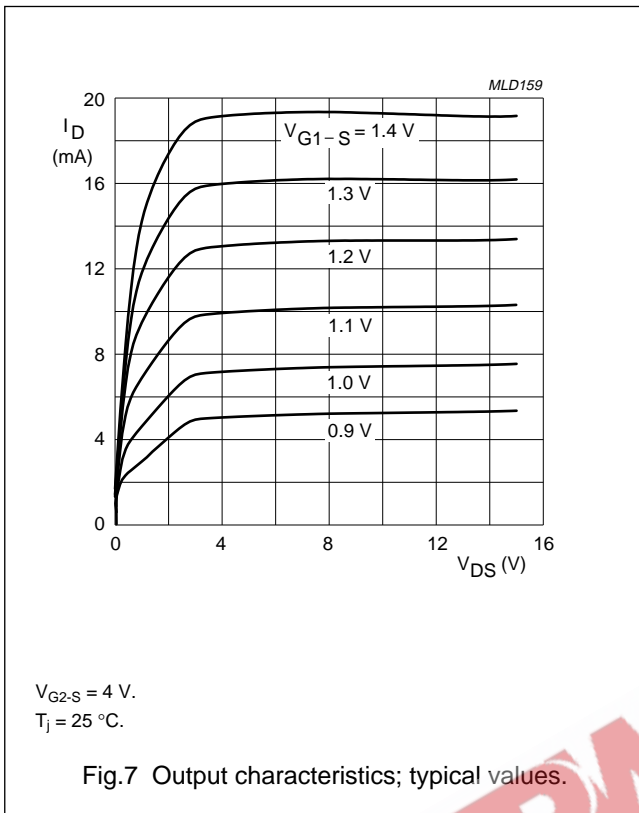

Dual-gate MOS-FETs

BF1100; BF1100R

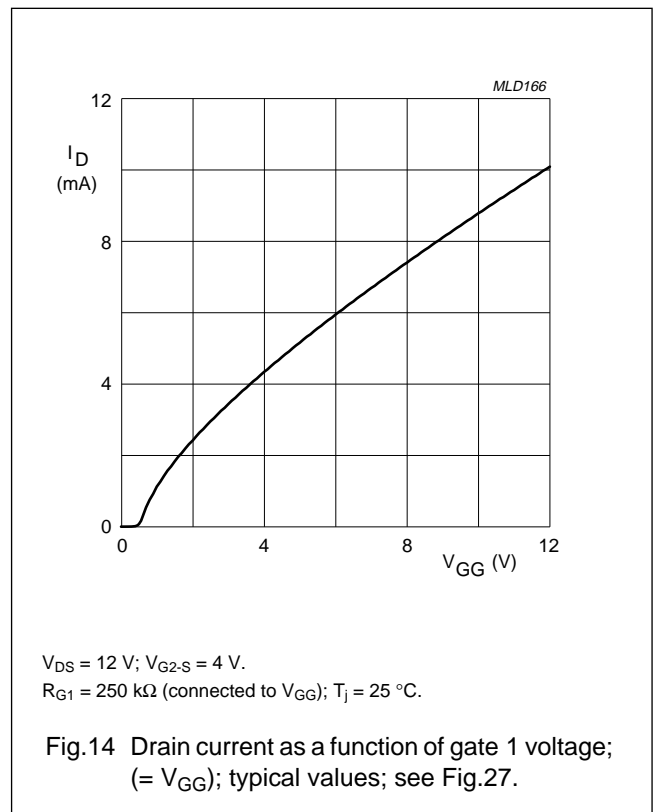
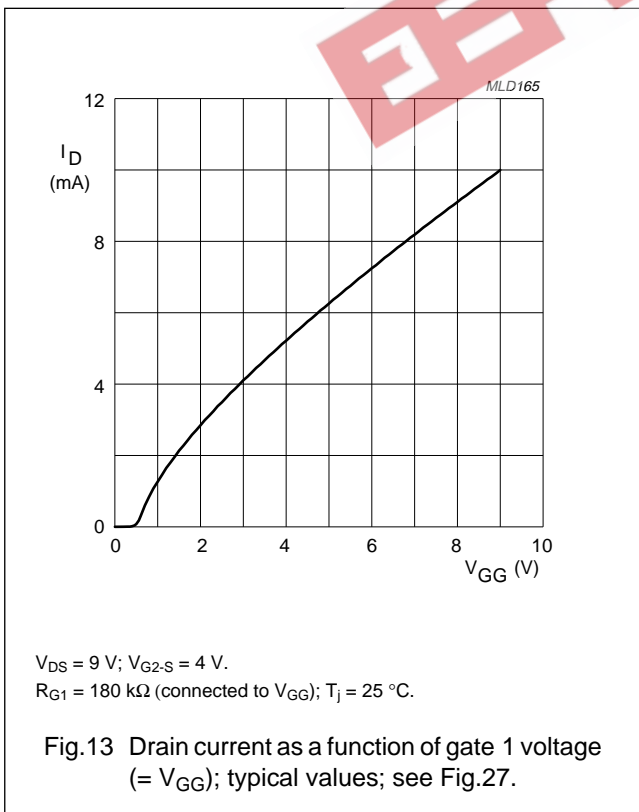
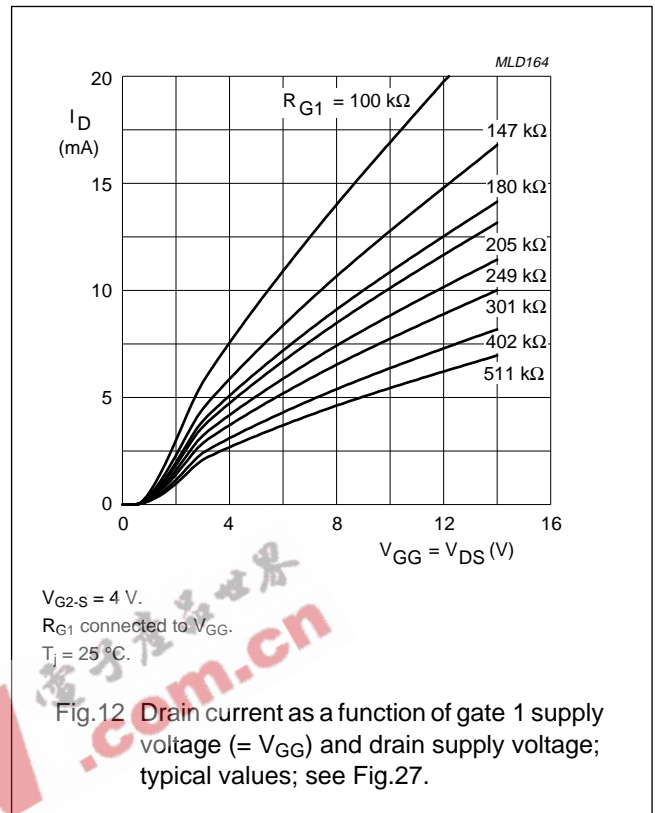
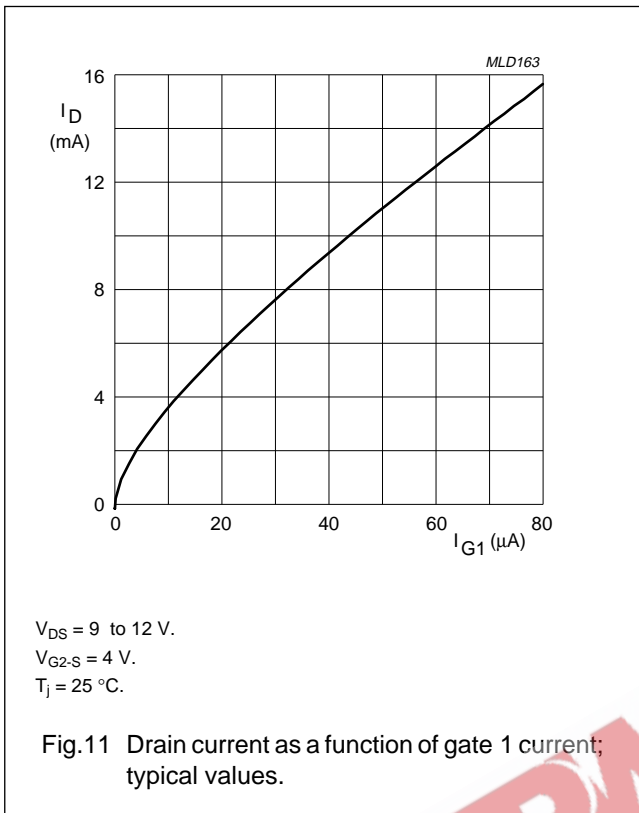

Dual-gate MOS-FETs

BF1100; BF1100R

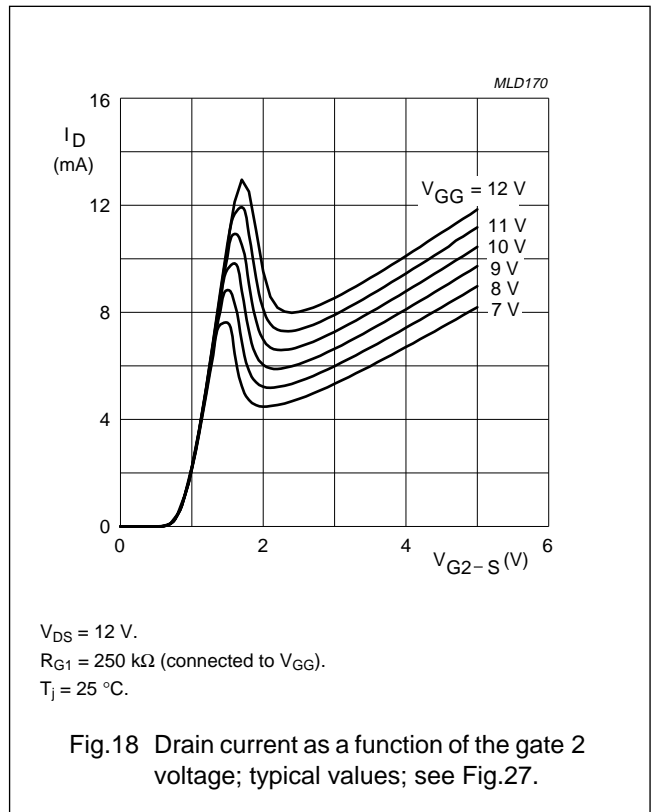
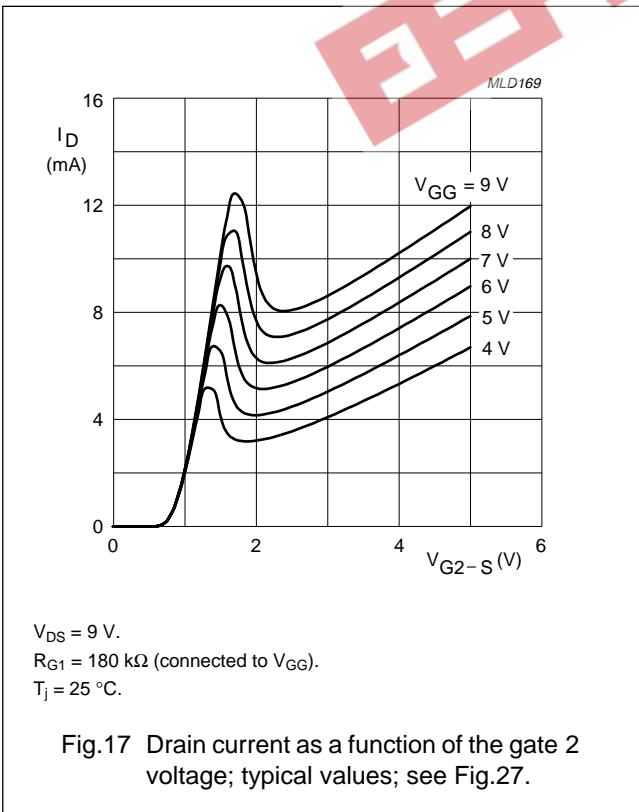
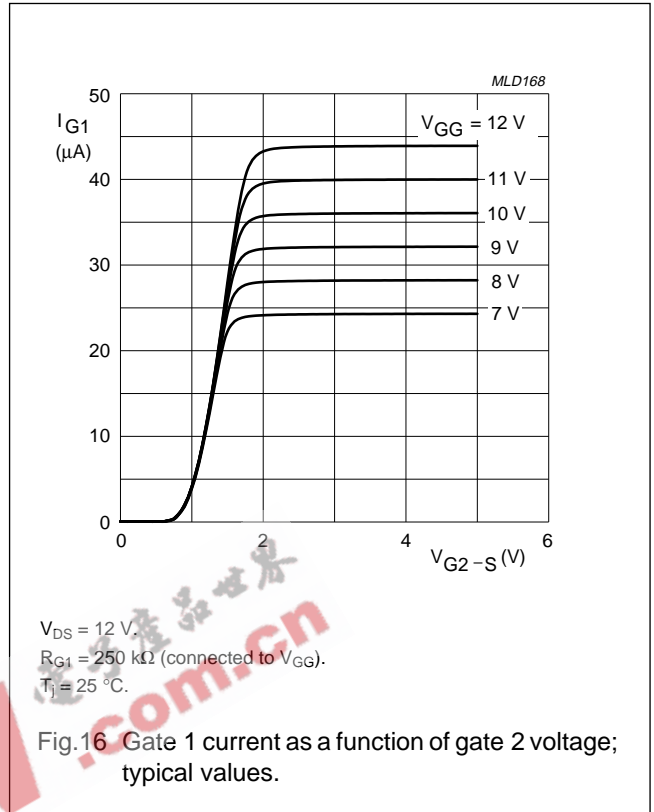
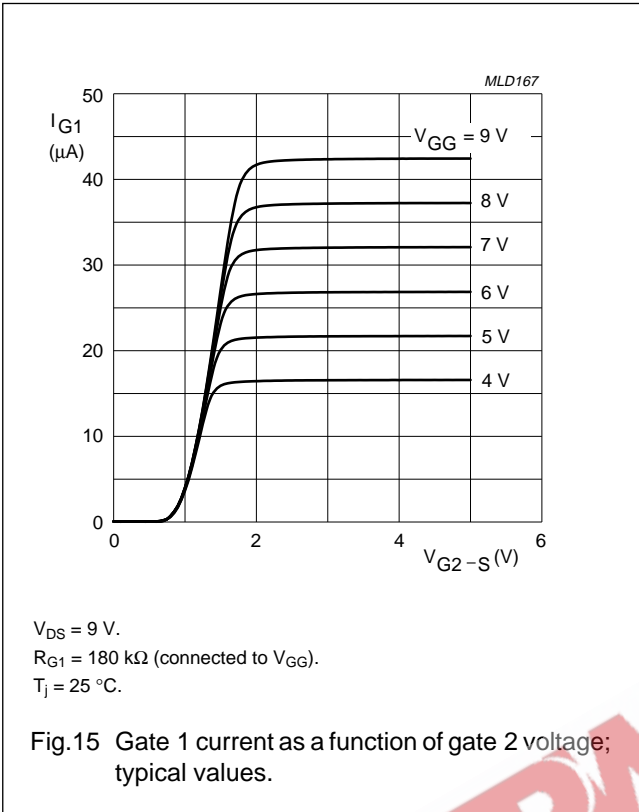



Dual-gate MOS-FETs

BF1100; BF1100R

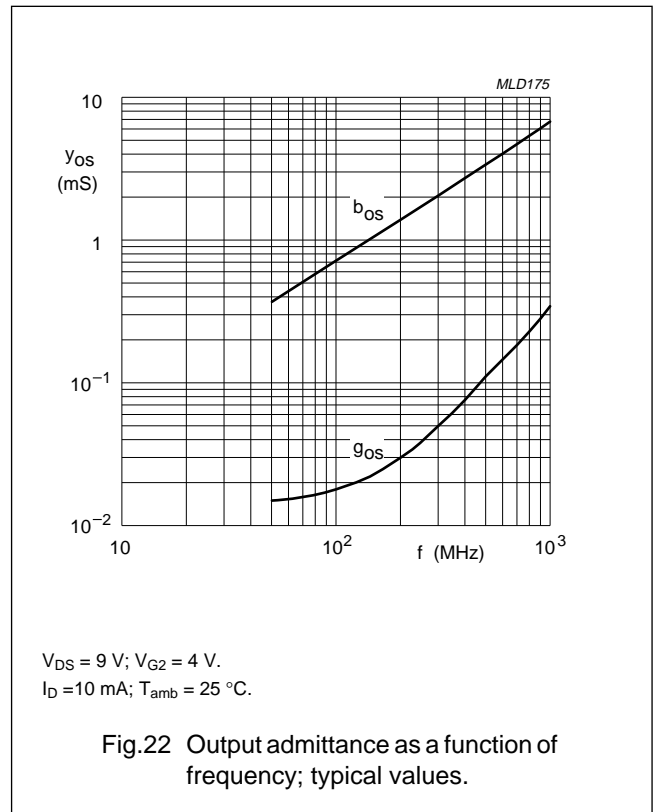
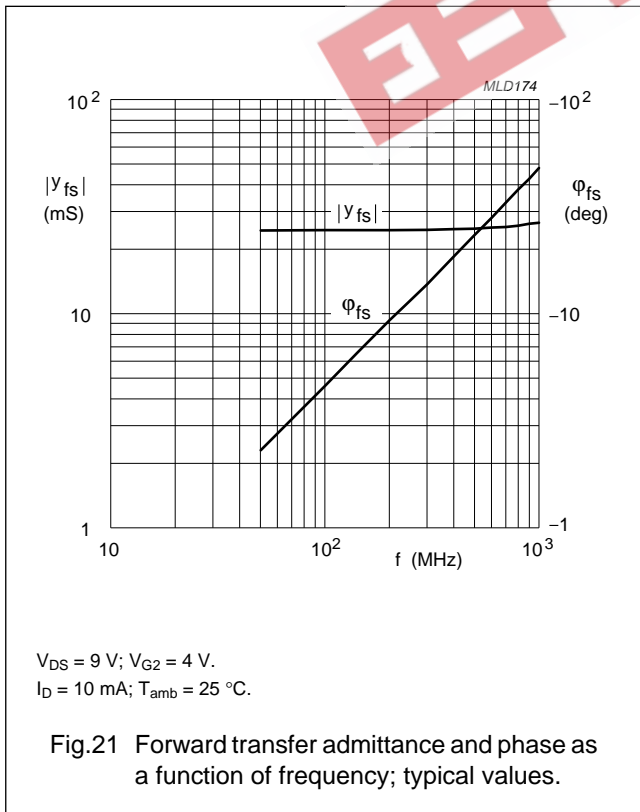
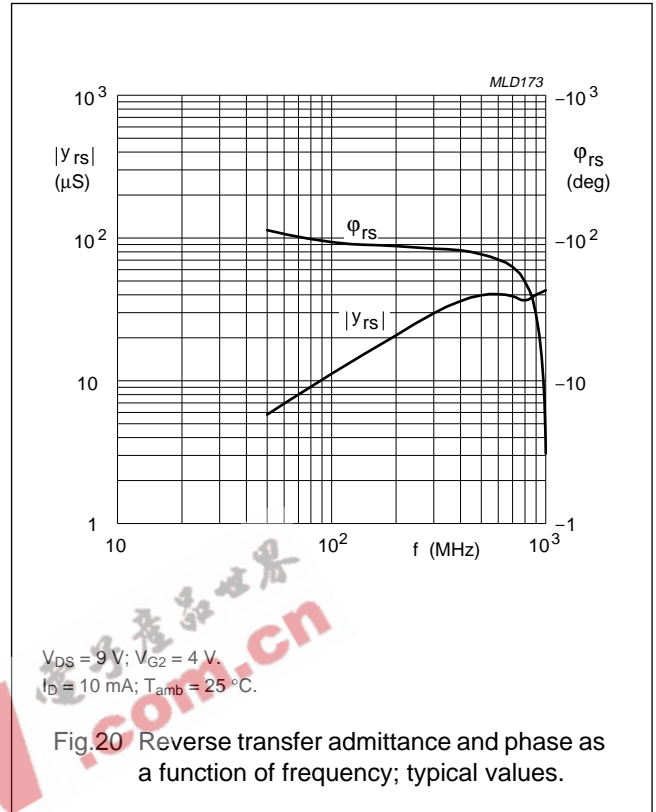
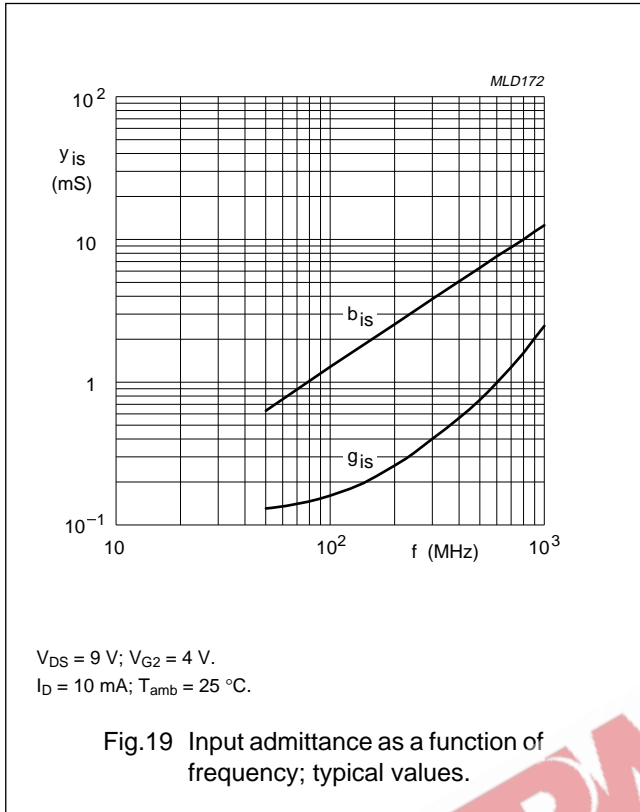

Dual-gate MOS-FETs

BF1100; BF1100R

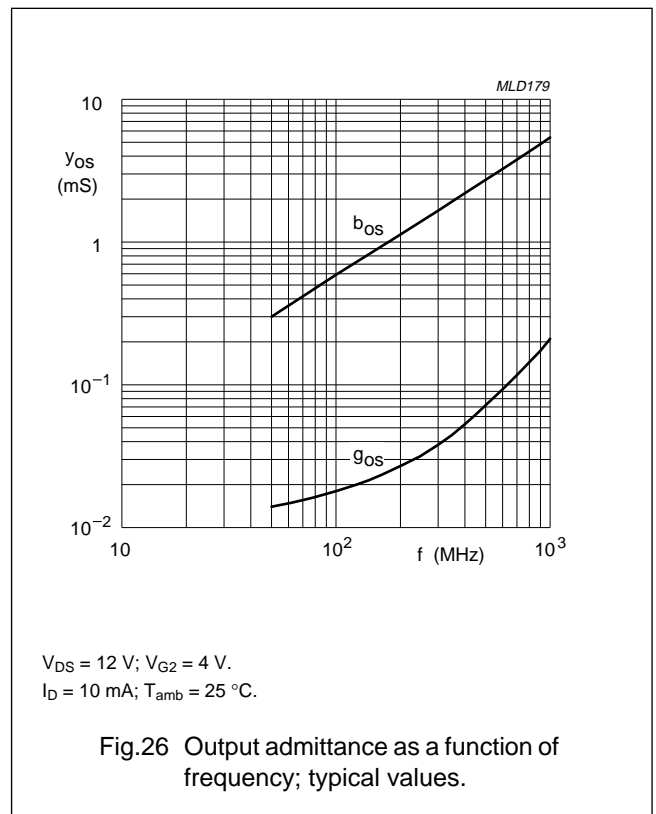
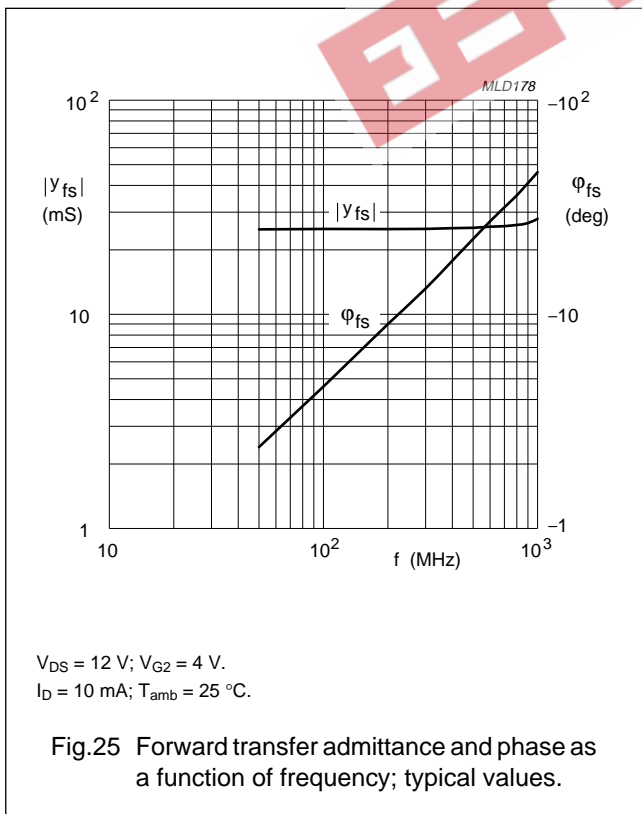
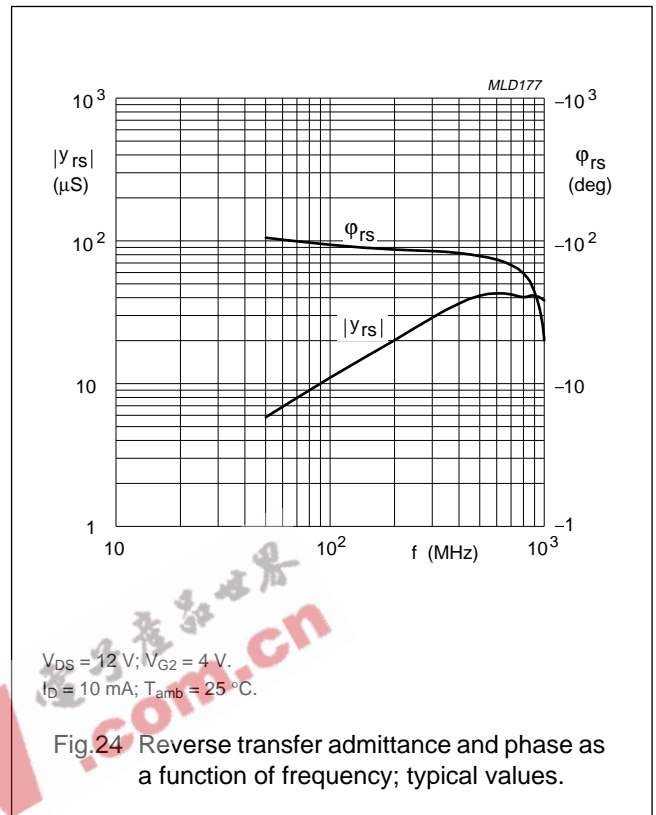
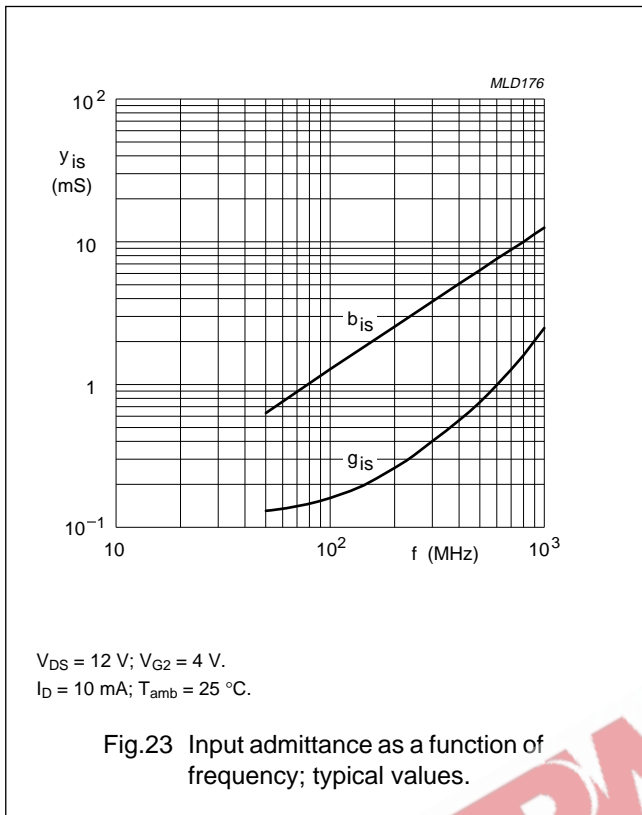

Dual-gate MOS-FETs

BF1100; BF1100R

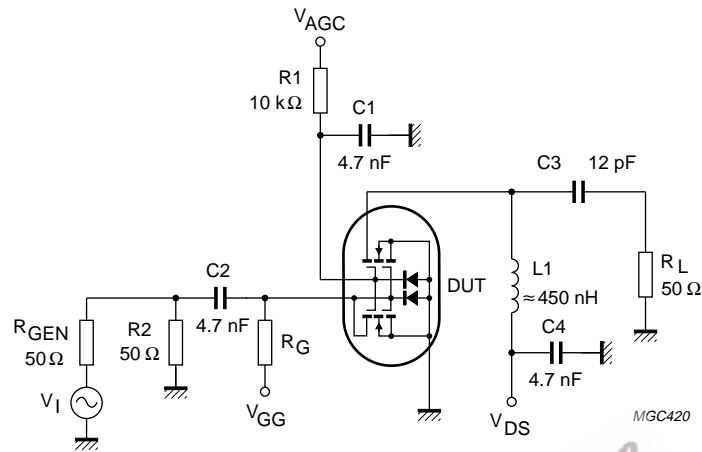

For  $V_{GG} = V_{DS} = 9\text{ V}$ ,  $R_G = 180\text{ k}\Omega$ .  
 For  $V_{GG} = V_{DS} = 12\text{ V}$ ,  $R_G = 250\text{ k}\Omega$ .

Fig.27 Cross-modulation test set-up.



## Dual-gate MOS-FETs

## BF1100; BF1100R

**Table 1** Scattering parameters:  $V_{DS} = 9\text{ V}$ ;  $V_{G2-S} = 4\text{ V}$ ;  $I_D = 10\text{ mA}$ 

f (MHz)	S <sub>11</sub>		S <sub>21</sub>		S <sub>12</sub>		S <sub>22</sub>	
	MAGNITUDE (ratio)	ANGLE (deg)	MAGNITUDE (ratio)	ANGLE (deg)	MAGNITUDE (ratio)	ANGLE (deg)	MAGNITUDE (ratio)	ANGLE (deg)
50	0.986	-3.6	2.528	174.4	0.001	63.7	1.000	-2.0
100	0.983	-7.4	2.531	169.8	0.001	80.7	1.000	-4.2
200	0.974	-14.7	2.490	159.5	0.002	81.0	0.996	-8.1
300	0.960	-21.8	2.446	149.8	0.002	80.3	0.994	-11.9
400	0.953	-28.7	2.412	139.8	0.003	76.3	0.992	-15.7
500	0.933	-35.4	2.341	130.1	0.003	76.5	0.987	-19.4
600	0.915	-42.0	2.283	120.4	0.004	79.0	0.984	-23.0
700	0.895	-47.9	2.205	111.6	0.003	81.5	0.981	-26.7
800	0.880	-53.5	2.146	102.9	0.003	90.8	0.978	-30.3
900	0.864	-59.6	2.087	93.4	0.003	106.6	0.974	-33.9
1000	0.839	-65.0	1.998	84.4	0.003	135.4	0.971	-37.6

**Table 2** Noise data:  $V_{DS} = 9\text{ V}$ ;  $V_{G2-S} = 4\text{ V}$ ;  $I_D = 10\text{ mA}$ 

f (MHz)	F <sub>min</sub> (dB)	Γ <sub>opt</sub>		r <sub>n</sub>
		(ratio)	(deg)	
800	2.00	0.67	43.9	0.89

**Table 3** Scattering parameters:  $V_{DS} = 12\text{ V}$ ;  $V_{G2-S} = 4\text{ V}$ ;  $I_D = 10\text{ mA}$ 

f (MHz)	S <sub>11</sub>		S <sub>21</sub>		S <sub>12</sub>		S <sub>22</sub>	
	MAGNITUDE (ratio)	ANGLE (deg)	MAGNITUDE (ratio)	ANGLE (deg)	MAGNITUDE (ratio)	ANGLE (deg)	MAGNITUDE (ratio)	ANGLE (deg)
50	0.986	-3.7	2.478	174.7	0.001	72.2	1.000	-1.6
100	0.984	-7.4	2.480	170.3	0.001	80.9	1.000	-3.5
200	0.974	-14.6	2.440	160.6	0.002	82.7	0.997	-6.6
300	0.960	-21.8	2.400	151.4	0.002	79.9	0.996	-9.7
400	0.953	-28.7	2.371	141.9	0.003	77.7	0.994	-12.8
500	0.933	-35.3	2.306	132.7	0.003	77.1	0.991	-15.8
600	0.915	-41.9	2.255	123.6	0.004	77.1	0.989	-18.7
700	0.894	-47.8	2.183	115.3	0.004	79.3	0.986	-21.7
800	0.879	-53.5	2.131	107.2	0.003	83.9	0.984	-24.6
900	0.863	-59.5	2.080	98.2	0.003	95.1	0.982	-27.5
1000	0.838	-65.0	1.999	89.7	0.003	115.8	0.980	-30.4

**Table 4** Noise data:  $V_{DS} = 12\text{ V}$ ;  $V_{G2-S} = 4\text{ V}$ ;  $I_D = 10\text{ mA}$ 

f (MHz)	F <sub>min</sub> (dB)	Γ <sub>opt</sub>		r <sub>n</sub>
		(ratio)	(deg)	
800	2.00	0.66	43.3	0.97

Dual-gate MOS-FETs

BF1100; BF1100R

PACKAGE OUTLINES

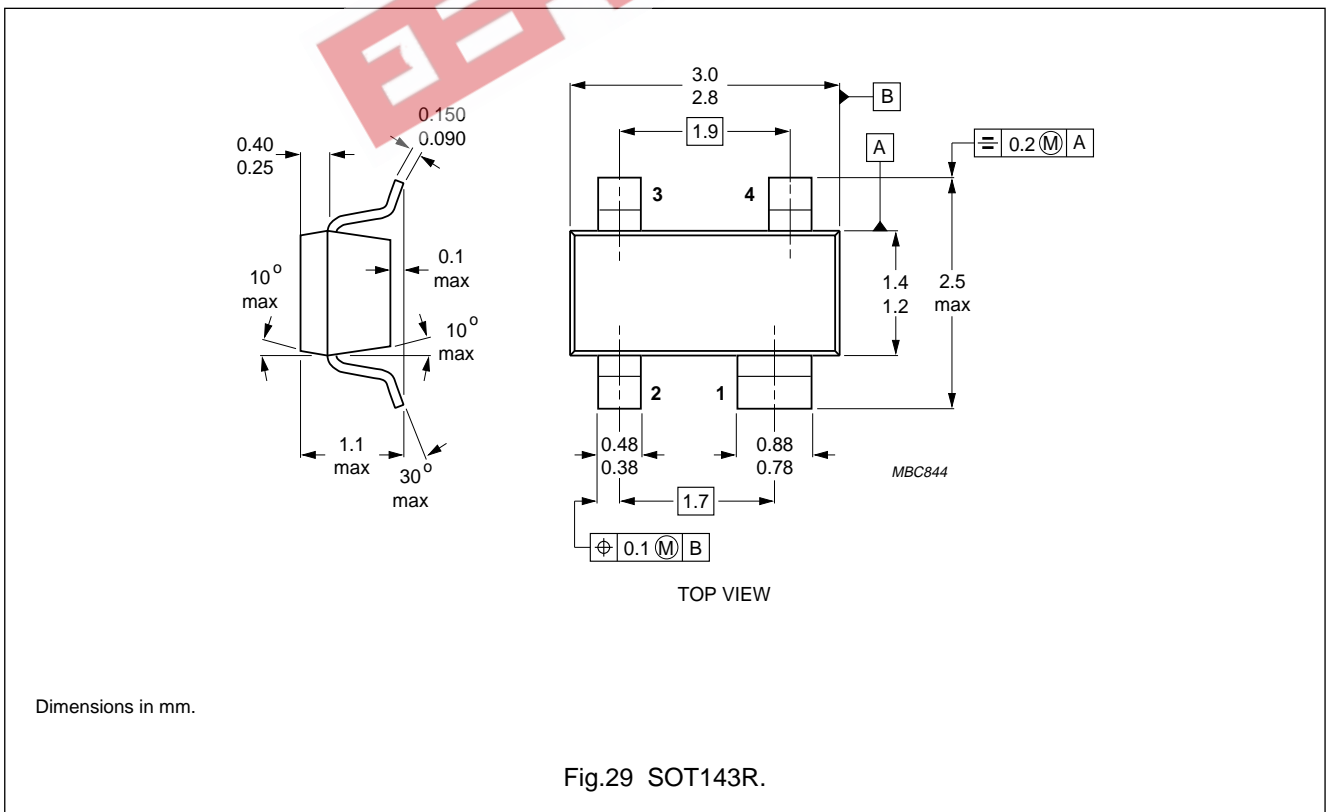
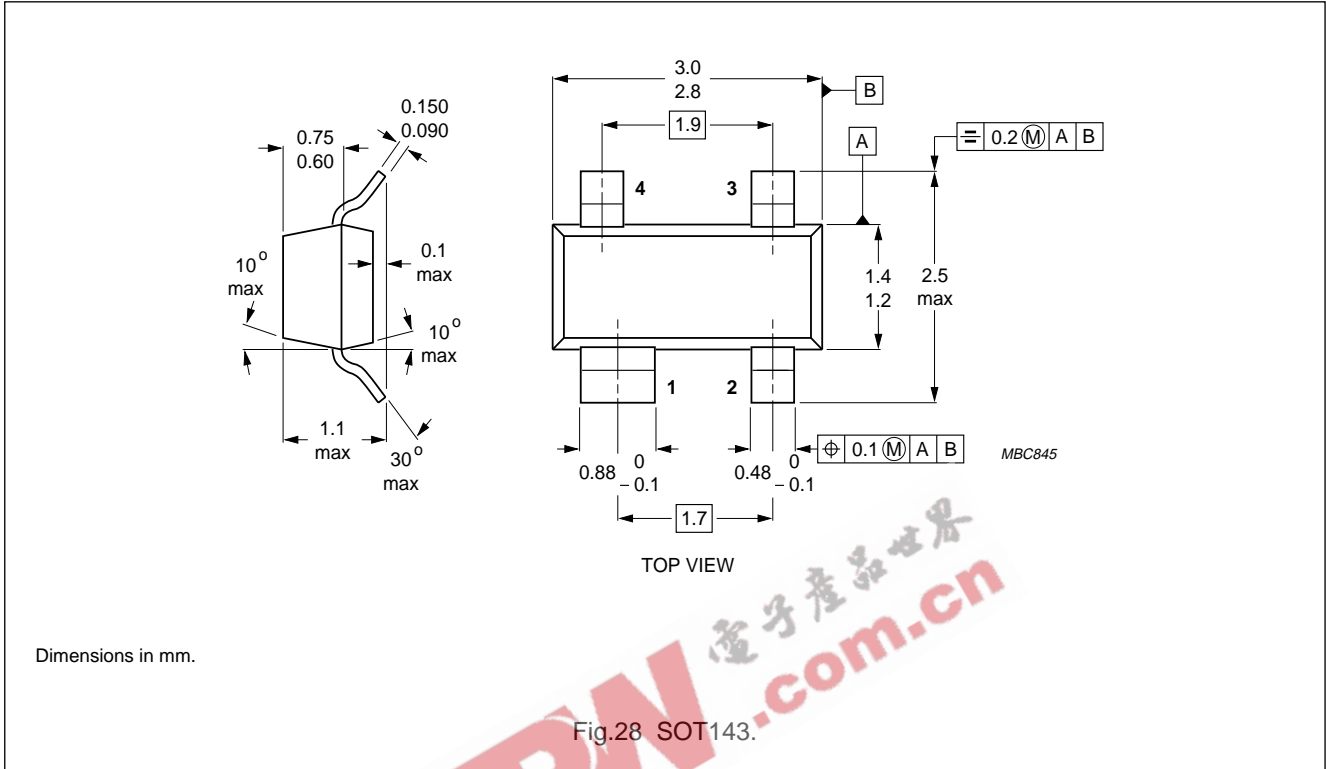

## Dual-gate MOS-FETs

BF1100; BF1100R

**DEFINITIONS**

<b>Data Sheet Status</b>	
Objective specification	This data sheet contains target or goal specifications for product development.
Preliminary specification	This data sheet contains preliminary data; supplementary data may be published later.
Product specification	This data sheet contains final product specifications.
<b>Limiting values</b>	
Limiting values given are in accordance with the Absolute Maximum Rating System (IEC 134). Stress above one or more of the limiting values may cause permanent damage to the device. These are stress ratings only and operation of the device at these or at any other conditions above those given in the Characteristics sections of the specification is not implied. Exposure to limiting values for extended periods may affect device reliability.	
<b>Application information</b>	
Where application information is given, it is advisory and does not form part of the specification.	

**LIFE SUPPORT APPLICATIONS**

These products are not designed for use in life support appliances, devices, or systems where malfunction of these products can reasonably be expected to result in personal injury. Philips customers using or selling these products for use in such applications do so at their own risk and agree to fully indemnify Philips for any damages resulting from such improper use or sale.

EEPW.com.cn