

PNP Silicon AF Transistors

BCX 69

- For general AF applications
- High collector current
- High current gain
- Low collector-emitter saturation voltage
- Complementary type: BCX 68 (NPN)



Type	Marking	Ordering Code (tape and reel)	Pin Configuration			Package ¹⁾
			1	2	3	
BCX 69	–	Q62702-C1714	B	C	E	SOT-89
BCX 69-10	CF	Q62702-C1867				
BCX 69-16	CG	Q62702-C1868				
BCX 69-25	CH	Q62702-C1869				

Maximum Ratings

Parameter	Symbol	Values	Unit
Collector-emitter voltage	V_{CE0}	20	V
Collector-base voltage	V_{CB0}	25	
Emitter-base voltage	V_{EB0}	5	
Collector current	I_C	1	A
Peak collector current	I_{CM}	2	
Base current	I_B	100	mA
Peak base current	I_{BM}	200	
Total power dissipation, $T_s = 130\text{ °C}$	P_{tot}	1	W
Junction temperature	T_j	150	°C
Storage temperature range	T_{stg}	– 65 ... + 150	

Thermal Resistance

Junction - ambient ²⁾	$R_{th\ JA}$	≤ 75	K/W
Junction - soldering point	$R_{th\ JS}$	≤ 20	

¹⁾ For detailed information see chapter Package Outlines.

²⁾ Package mounted on epoxy pcb 40 mm × 40 mm × 1.5 mm/6 cm² Cu.

Electrical Characteristics

at $T_A = 25\text{ °C}$, unless otherwise specified.

Parameter	Symbol	Values			Unit
		min.	typ.	max.	

DC characteristics

Collector-emitter breakdown voltage $I_C = 30\text{ mA}$	$V_{(BR)CE0}$	20	–	–	V
Collector-base breakdown voltage $I_C = 10\text{ }\mu\text{A}$	$V_{(BR)CB0}$	25	–	–	
Emitter-base breakdown voltage $I_E = 1\text{ }\mu\text{A}$	$V_{(BR)EB0}$	5	–	–	
Collector cutoff current $V_{CB} = 25\text{ V}$ $V_{CB} = 25\text{ V}, T_A = 150\text{ °C}$	I_{CB0}	–	–	100	nA μA
Emitter cutoff current $V_{EB} = 5\text{ V}$	I_{EB0}	–	–	10	μA
DC current gain ¹⁾ $I_C = 5\text{ mA}, V_{CE} = 10\text{ V}$ $I_C = 500\text{ mA}, V_{CE} = 1\text{ V}$	h_{FE}	50	–	–	–
		85	–	375	
		85	100	160	
		100	160	250	
		160	250	375	
$I_C = 1\text{ A}, V_{CE} = 1\text{ V}$		60	–	–	
Collector-emitter saturation voltage ¹⁾ $I_C = 1\text{ A}, I_B = 100\text{ mA}$	V_{CEsat}	–	–	0.5	V
Base-emitter voltage ¹⁾ $I_C = 5\text{ mA}, V_{CE} = 10\text{ V}$ $I_C = 1\text{ A}, V_{CE} = 1\text{ V}$	V_{BE}	–	0.6	–	
		–	–	1	

AC characteristics

Transition frequency $I_C = 100\text{ mA}, V_{CE} = 5\text{ V}, f = 20\text{ MHz}$	f_T	–	100	–	MHz
---	-------	---	-----	---	-----

¹⁾ Pulse test: $t \leq 300\text{ }\mu\text{s}, D = 2\text{ %}$.

Total power dissipation $P_{tot} = f(T_A^*; T_S)$

* Package mounted on epoxy

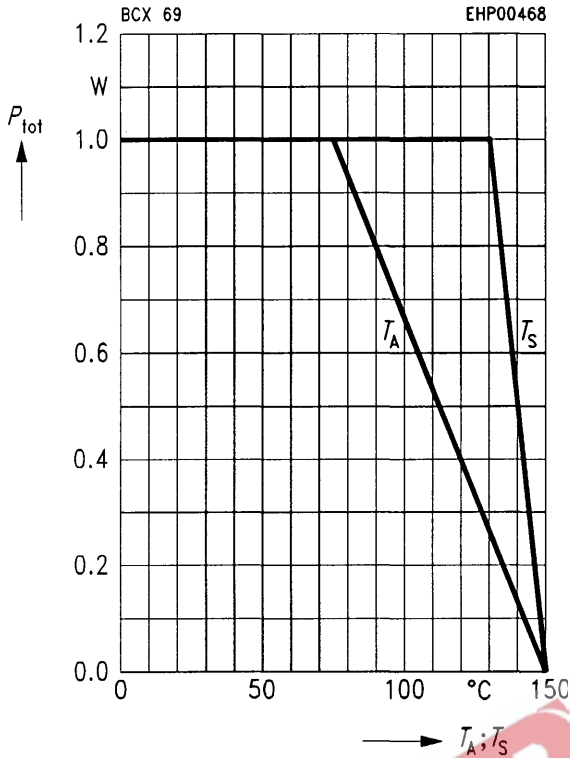

Transition frequency $f_T = f(I_C)$

$V_{CE} = 5 V$

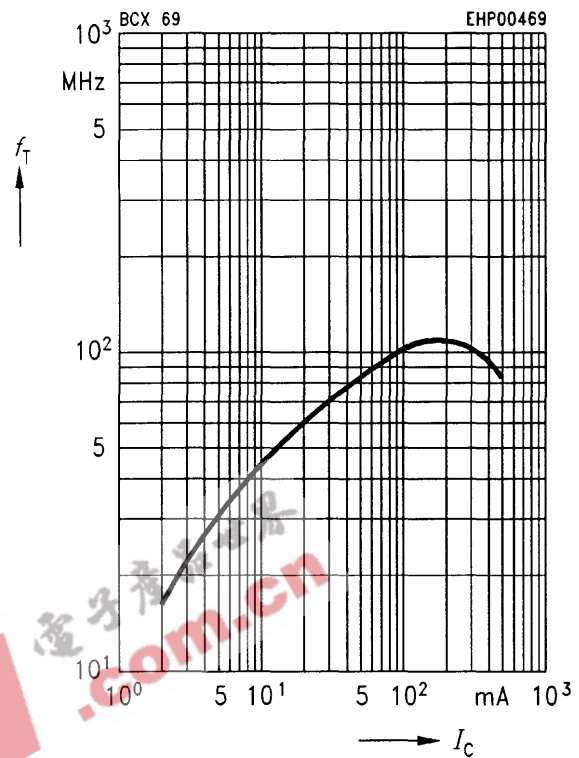

Permissible pulse load $P_{tot max}/P_{tot DC} = f(t_p)$

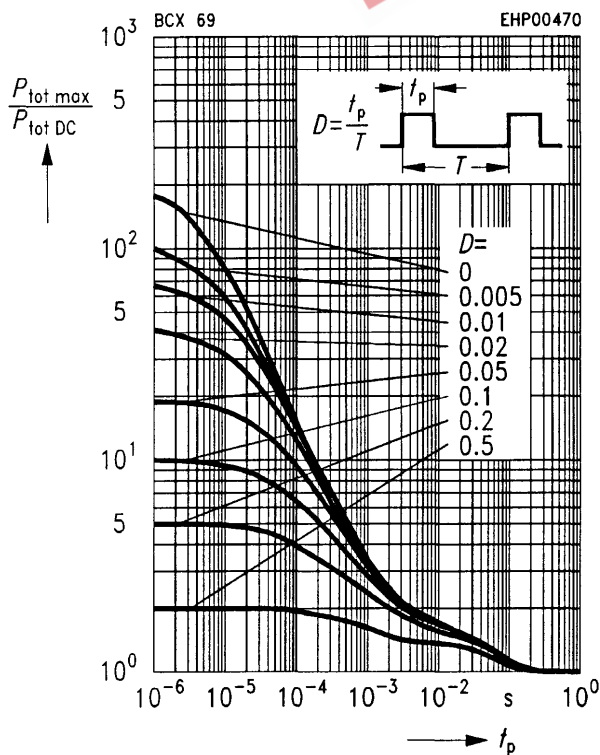

Collector cutoff current $I_{CB0} = f(T_A)$

$V_{CB} = 25 V$

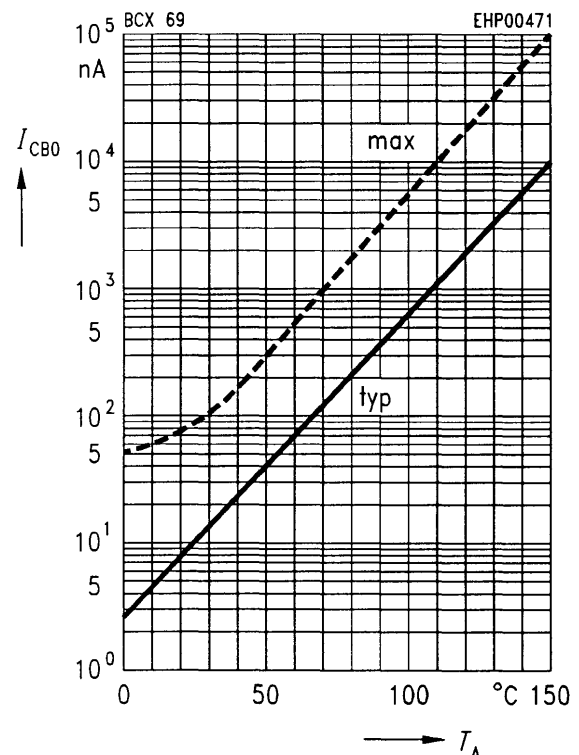

Base-emitter saturation voltage

$I_C = f(V_{BEsat})$

$h_{FE} = 10$

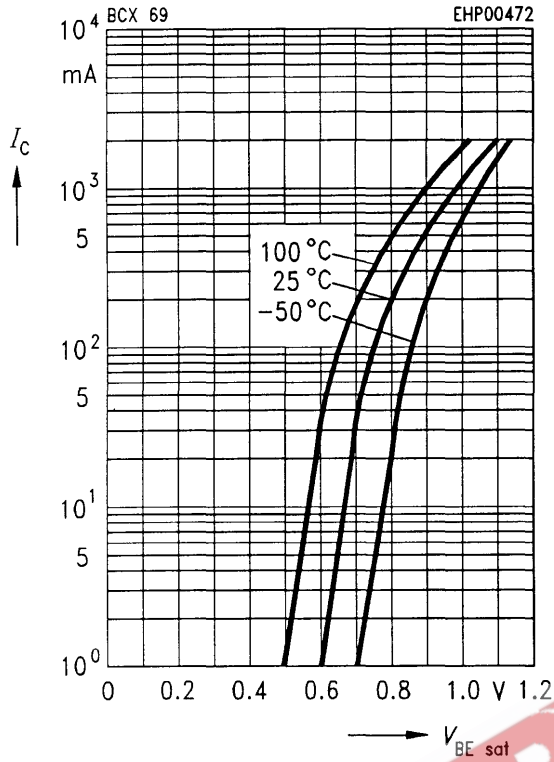

Collector-emitter saturation voltage

$I_C = f(V_{CEsat})$

$h_{FE} = 10$

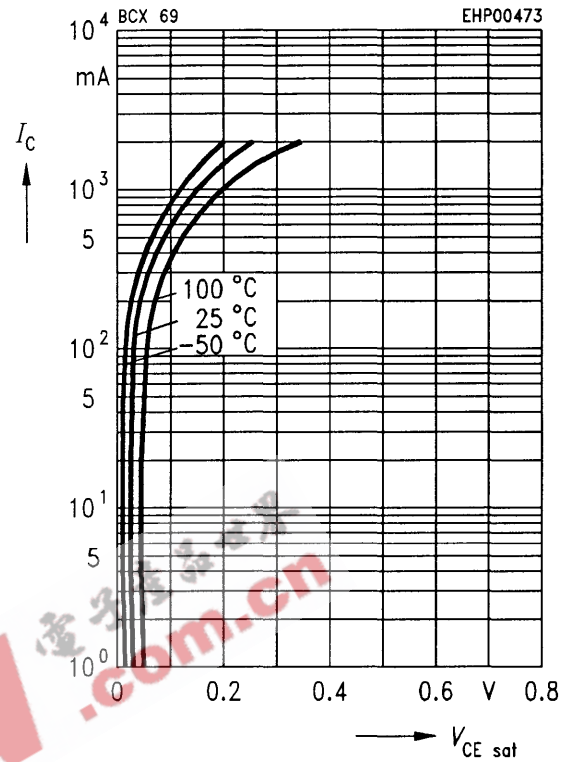

Collector current $I_C = f(V_{BE})$

$V_{CE} = 1 V$

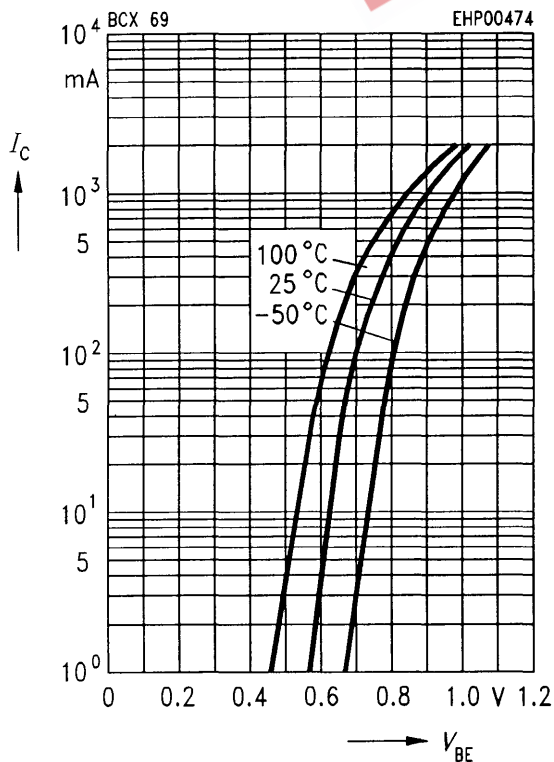

DC current gain $h_{FE} = f(I_C)$

$V_{CE} = 1 V$

