

Three quadrant triacs guaranteed commutation

BTA208S series D, E and F

GENERAL DESCRIPTION

Passivated guaranteed commutation triacs in a plastic envelope suitable for surface mounting, intended for use in motor control circuits or with other highly inductive loads. These devices balance the requirements of commutation performance and gate sensitivity. The "sensitive gate" E series and "logic level" D series are intended for interfacing with low power drivers, including micro controllers.

QUICK REFERENCE DATA

SYMBOL	PARAMETER	MAX.	MAX.	UNIT
V_{DRM}	Repetitive peak off-state voltages	600D 600E 600F 600	- 800E 800F 800	V
$I_{\text{T(RMS)}}$	RMS on-state current	8	8	A
I_{TSM}	Non-repetitive peak on-state current	65	65	A

PINNING - SOT428

PIN	DESCRIPTION
1	MT1
2	MT2
3	gate
tab	MT2

PIN CONFIGURATION

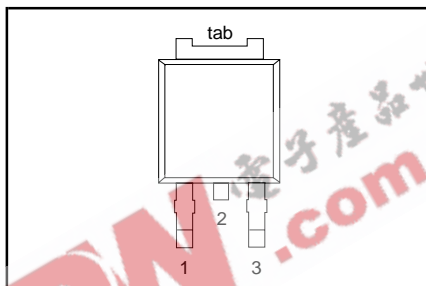

SYMBOL

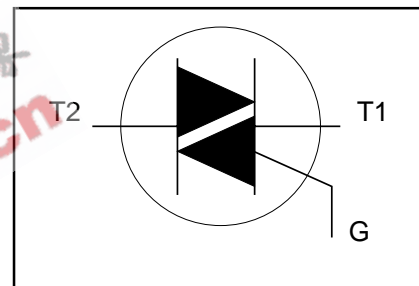

LIMITING VALUES

Limiting values in accordance with the Absolute Maximum System (IEC 134).

SYMBOL	PARAMETER	CONDITIONS	MIN.	MAX.		UNIT
				-600 600 ¹	-800 800	
V_{DRM}	Repetitive peak off-state voltages		-	-600 600 ¹	-800 800	V
$I_{\text{T(RMS)}}$	RMS on-state current	full sine wave; $T_{\text{mb}} \leq 102\text{ }^{\circ}\text{C}$	-	8		A
I_{TSM}	Non-repetitive peak on-state current	full sine wave; $T_{\text{j}} = 25\text{ }^{\circ}\text{C}$ prior to surge $t = 20\text{ ms}$ $t = 16.7\text{ ms}$ $t = 10\text{ ms}$	-	65	72	A
I^2t	I^2t for fusing		-	21	100	A ² s
di_{T}/dt	Repetitive rate of rise of on-state current after triggering	$I_{\text{TM}} = 12\text{ A}$; $I_{\text{G}} = 0.2\text{ A}$; $di_{\text{G}}/dt = 0.2\text{ A}/\mu\text{s}$	-	100		A/ μs
I_{GM}	Peak gate current		-	2		A
V_{GM}	Peak gate voltage		-	5		V
P_{GM}	Peak gate power		-	5		W
$P_{\text{G(AV)}}$	Average gate power	over any 20 ms period	-	0.5		W
T_{stg}	Storage temperature		-40	150		$^{\circ}\text{C}$
T_{j}	Operating junction temperature		-	125		$^{\circ}\text{C}$

¹ Although not recommended, off-state voltages up to 800V may be applied without damage, but the triac may switch to the on-state. The rate of rise of current should not exceed 6 A/ μs .

Three quadrant triacs guaranteed commutation

BTA208S series D, E and F

THERMAL RESISTANCES

SYMBOL	PARAMETER	CONDITIONS	MIN.	TYP.	MAX.	UNIT
$R_{th\ j-mb}$	Thermal resistance junction to mounting base	full cycle	-	-	2.0	K/W
$R_{th\ j-a}$	Thermal resistance junction to ambient	half cycle pcb (FR4) mounted; footprint as in Fig.14	-	-	2.4	K/W
			-	75	-	K/W

STATIC CHARACTERISTICS

$T_j = 25\text{ °C}$ unless otherwise stated

SYMBOL	PARAMETER	CONDITIONS	MIN.	TYP.	MAX.	UNIT		
		BTA208S-		...D	...D	...E	...F	
I_{GT}	Gate trigger current ²	$V_D = 12\text{ V}; I_T = 0.1\text{ A}$ T2+ G+ T2+ G- T2- G-	-	0.8	5	10	25	mA
			-	2.0	5	10	25	mA
			-	3.2	5	10	25	mA
I_L	Latching current	$V_D = 12\text{ V}; I_{GT} = 0.1\text{ A}$ T2+ G+ T2+ G- T2- G-	-	7.2	15	25	30	mA
			-	8.2	25	30	40	mA
			-	11.0	25	30	40	mA
I_H	Holding current	$V_D = 12\text{ V}; I_{GT} = 0.1\text{ A}$	-	5.3	15	25	30	mA
			...D, E, F					
V_T	On-state voltage	$I_T = 10\text{ A}$	-	1.3	1.65			V
V_{GT}	Gate trigger voltage	$V_D = 12\text{ V}; I_T = 0.1\text{ A}$ $V_D = 400\text{ V}; I_T = 0.1\text{ A};$ $T_j = 125\text{ °C}$	-	0.7	1.5			V
			0.25	0.4	-			V
I_D	Off-state leakage current	$V_D = V_{DRM(max)};$ $T_j = 125\text{ °C}$	-	0.1	0.5			mA

DYNAMIC CHARACTERISTICS

$T_j = 25\text{ °C}$ unless otherwise stated

SYMBOL	PARAMETER	CONDITIONS	MIN.	TYP.	MAX.	UNIT		
		BTA208S-	...D	...E	...F	...D		
dV_D/dt	Critical rate of rise of off-state voltage	$V_{DM} = 67\% V_{DRM(max)};$ $T_j = 110\text{ °C};$ exponential waveform; gate open circuit	20	60	70	60	-	V/ μ s
dI_{com}/dt	Critical rate of change of commutating current	$V_{DM} = 400\text{ V}; T_j = 110\text{ °C};$ $I_{T(RMS)} = 8\text{ A};$ $dV_{com}/dt = 20\text{ V}/\mu\text{s};$ gate open circuit	1.8	3.5	5	8.5	-	A/ms
dI_{com}/dt	Critical rate of change of commutating current	$V_{DM} = 400\text{ V}; T_j = 110\text{ °C};$ $I_{T(RMS)} = 8\text{ A};$ $dV_{com}/dt = 0.1\text{ V}/\mu\text{s};$ gate open circuit	5	16	19	100	-	A/ms
			...D, E, F					
t_{gt}	Gate controlled turn-on time	$I_{TM} = 12\text{ A}; V_D = V_{DRM(max)};$ $I_G = 0.1\text{ A}; dI_G/dt = 5\text{ A}/\mu\text{s}$	-	-	-	2	-	μ s

² Device does not trigger in the T2-, G+ quadrant.

Three quadrant triacs
guaranteed commutation

BTA208S series D, E and F

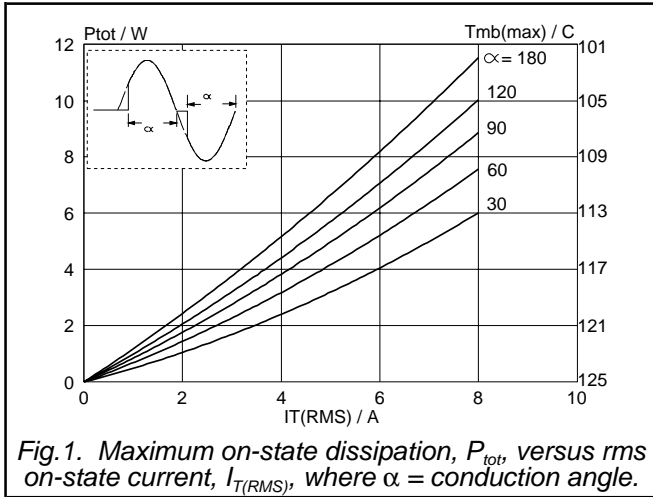

Fig.1. Maximum on-state dissipation, P_{tot} , versus rms on-state current, $I_{T(RMS)}$, where α = conduction angle.

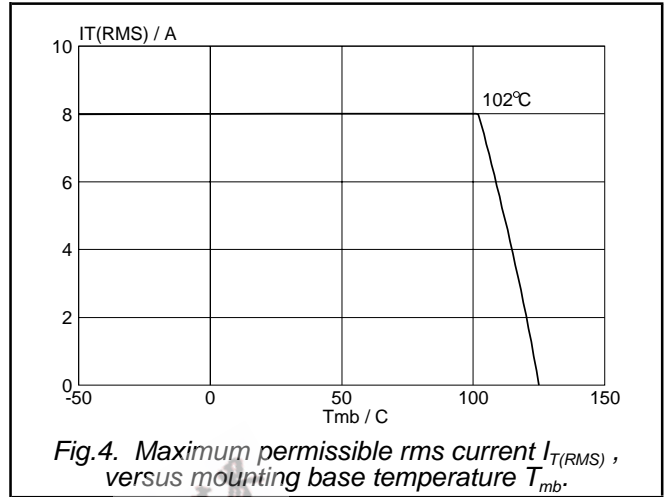

Fig.4. Maximum permissible rms current $I_{T(RMS)}$, versus mounting base temperature T_{mb} .

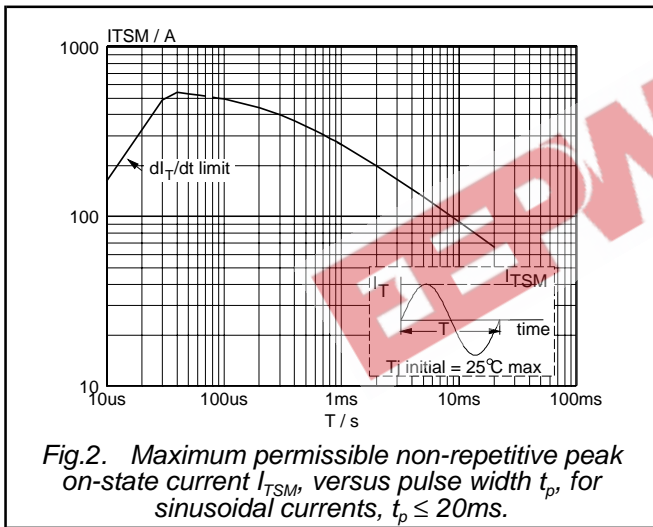

Fig.2. Maximum permissible non-repetitive peak on-state current I_{TSM} , versus pulse width t_p , for sinusoidal currents, $t_p \leq 20ms$.

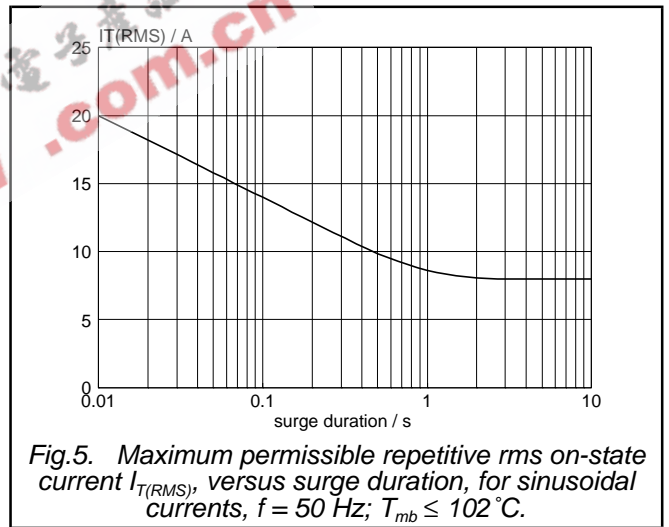

Fig.5. Maximum permissible repetitive rms on-state current $I_{T(RMS)}$, versus surge duration, for sinusoidal currents, $f = 50 Hz$; $T_{mb} \leq 102^\circ C$.

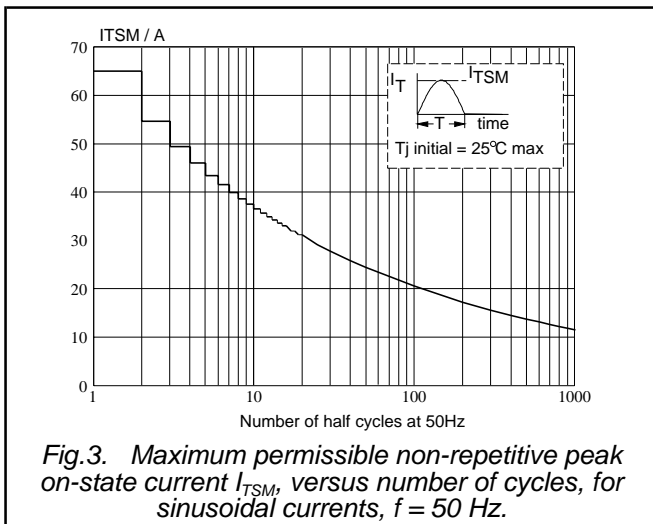

Fig.3. Maximum permissible non-repetitive peak on-state current I_{TSM} , versus number of cycles, for sinusoidal currents, $f = 50 Hz$.

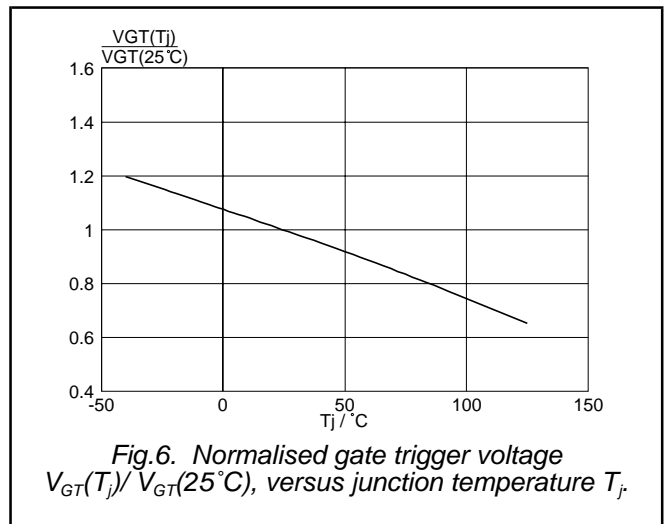
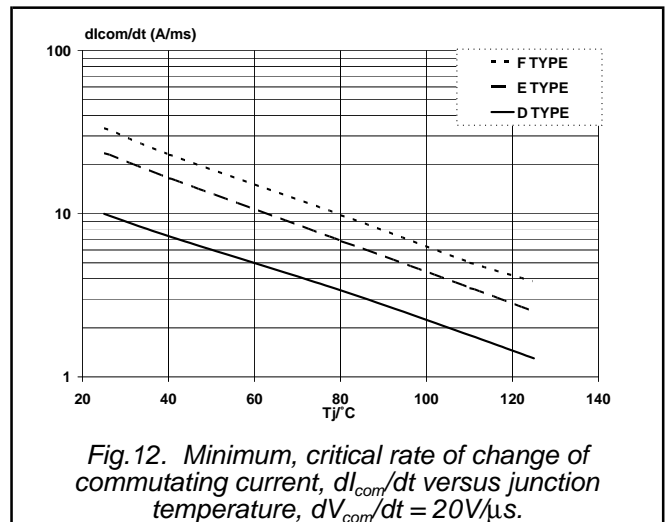
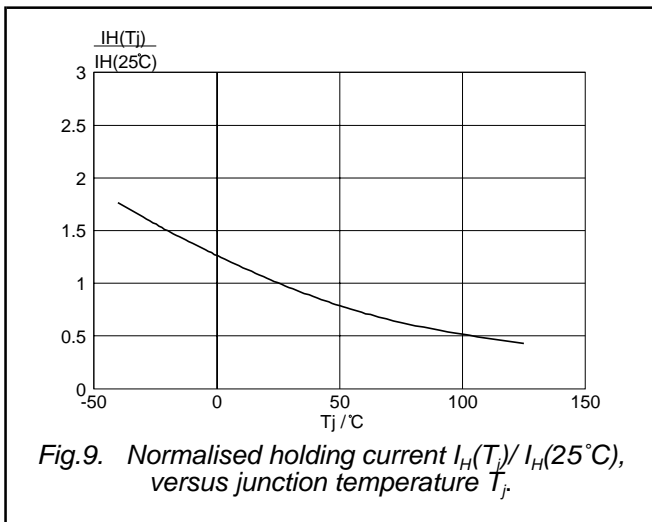
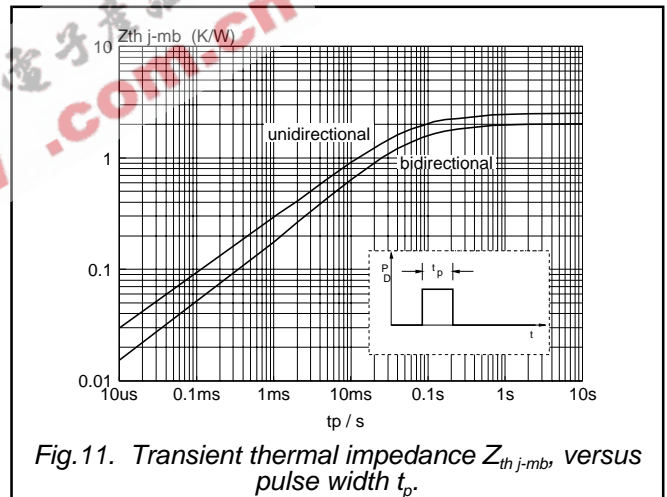
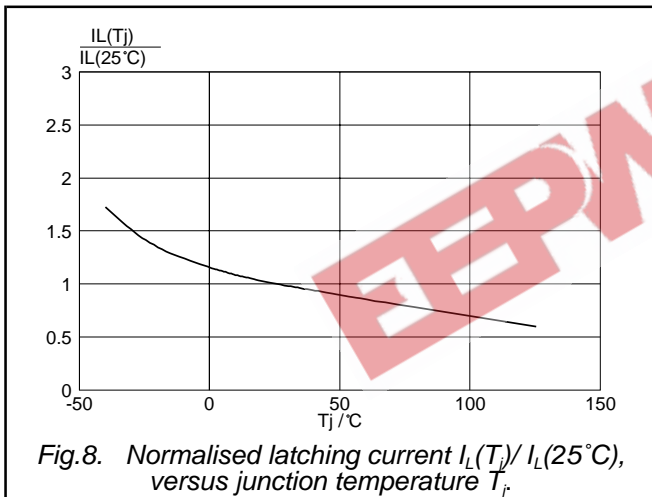
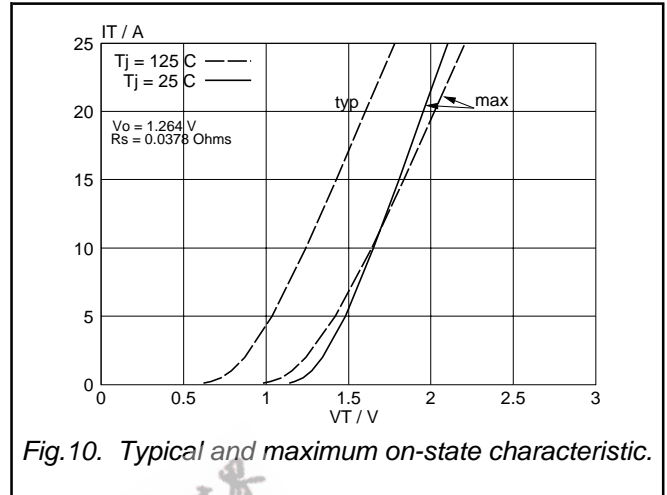
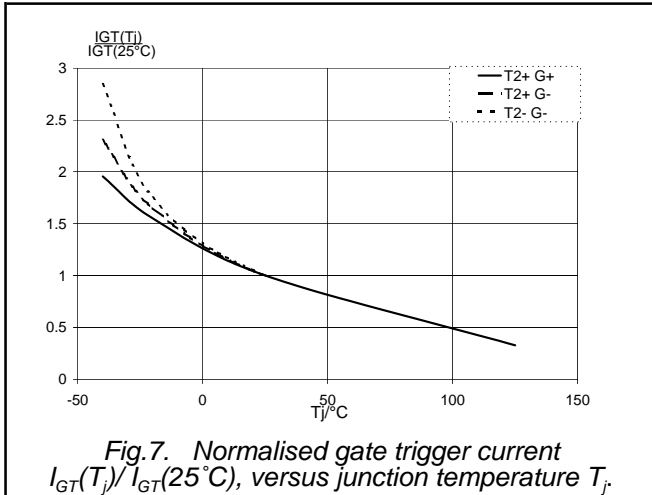

Fig.6. Normalised gate trigger voltage $V_{GT}(T_j) / V_{GT}(25^\circ C)$, versus junction temperature T_j .

Three quadrant triacs
guaranteed commutation

BTA208S series D, E and F



Three quadrant triacs
guaranteed commutation

BTA208S series D, E and F

MECHANICAL DATA

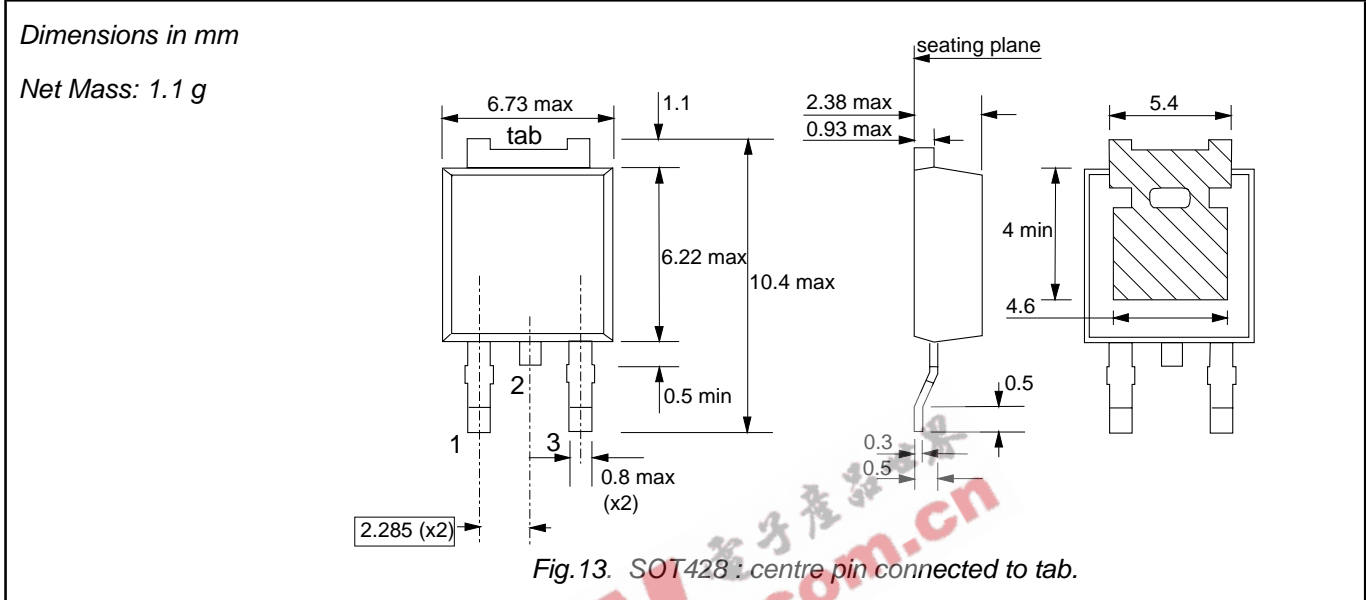

MOUNTING INSTRUCTIONS

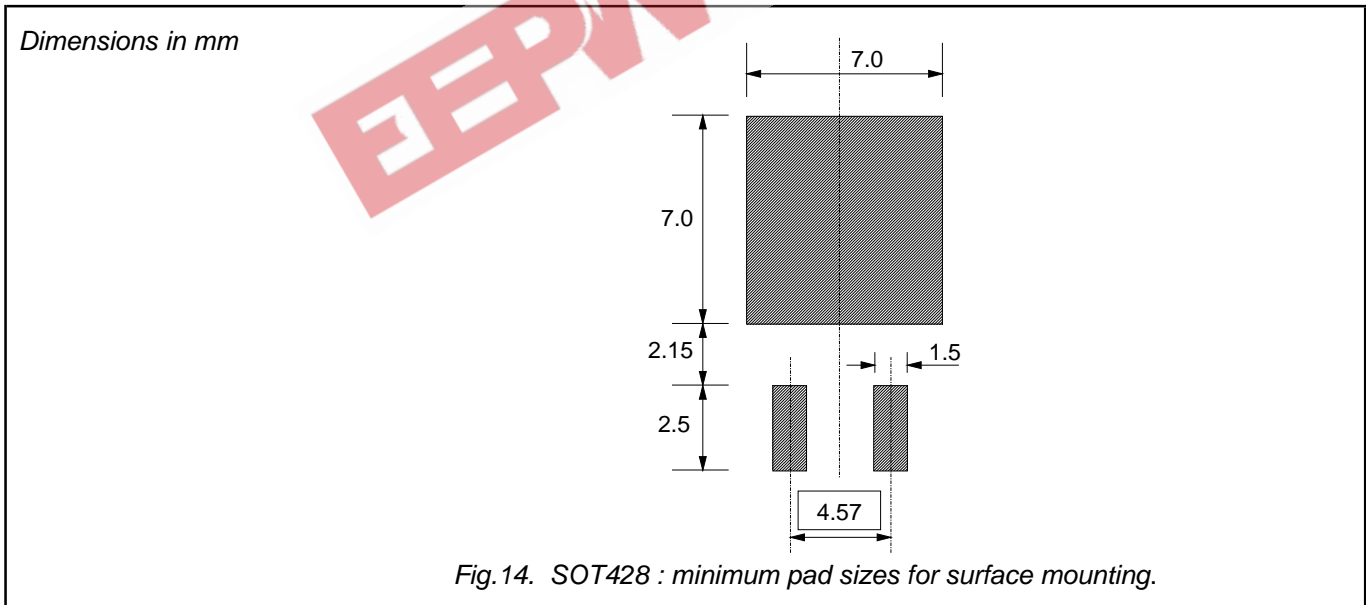

Notes

1. Plastic meets UL94 V0 at 1/8".

Three quadrant triacs guaranteed commutation

BTA208S series D, E and F

DEFINITIONS

Data sheet status	
Objective specification	This data sheet contains target or goal specifications for product development.
Preliminary specification	This data sheet contains preliminary data; supplementary data may be published later.
Product specification	This data sheet contains final product specifications.
Limiting values	
Limiting values are given in accordance with the Absolute Maximum Rating System (IEC 134). Stress above one or more of the limiting values may cause permanent damage to the device. These are stress ratings only and operation of the device at these or at any other conditions above those given in the Characteristics sections of this specification is not implied. Exposure to limiting values for extended periods may affect device reliability.	
Application information	
Where application information is given, it is advisory and does not form part of the specification.	
© Philips Electronics N.V. 2000	
All rights are reserved. Reproduction in whole or in part is prohibited without the prior written consent of the copyright owner.	
The information presented in this document does not form part of any quotation or contract, it is believed to be accurate and reliable and may be changed without notice. No liability will be accepted by the publisher for any consequence of its use. Publication thereof does not convey nor imply any license under patent or other industrial or intellectual property rights.	

LIFE SUPPORT APPLICATIONS

These products are not designed for use in life support appliances, devices or systems where malfunction of these products can be reasonably expected to result in personal injury. Philips customers using or selling these products for use in such applications do so at their own risk and agree to fully indemnify Philips for any damages resulting from such improper use or sale.