

**General Purpose PNP Epitaxial Planar Transistor**

# BTA1514N3

**Description**

- The BTA1514N3 is designed for general purpose applications requiring high breakdown voltage.

**Features**

- High collector-emitter breakdown voltage. ( $BV_{CEO}=150V @ I_C=1mA$ )
- Complement to NPN type BTC3906N3

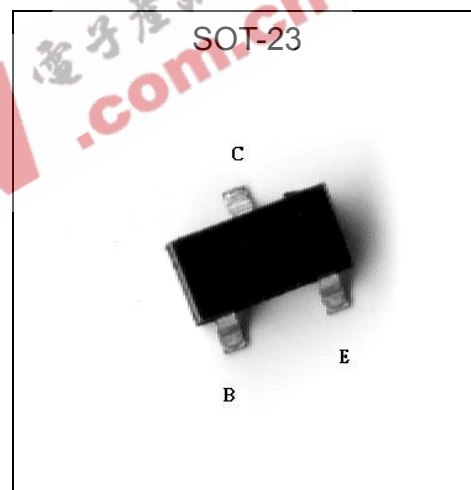
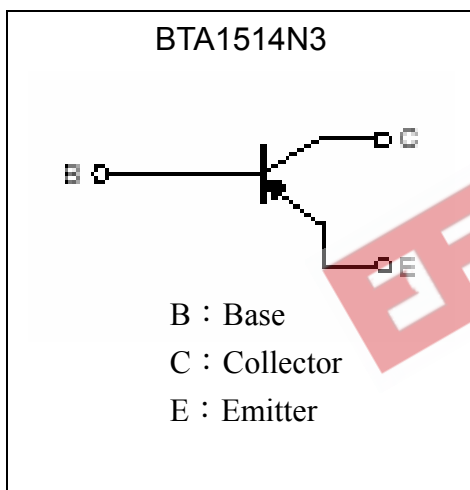
**Equivalent Circuit**

**Absolute Maximum Ratings** ( $T_a=25^{\circ}C$ )

Parameter	Symbol	Limits	Unit
Collector-Base Voltage	VCBO	-160	V
Collector-Emitter Voltage	VCEO	-150	V
Emitter-Base Voltage	VEBO	-5	V
Collector Current	$I_C$	600	mA
Power Dissipation	$P_d$	225	mW
Junction Temperature	$T_j$	150	$^{\circ}C$
Storage Temperature	$T_{stg}$	-55~+150	$^{\circ}C$

**Characteristics (Ta=25°C)**

Symbol	Min.	Typ.	Max.	Unit	Test Conditions
BVCBO	-160	-	-	V	IC=-50uA
BVCEO	-150	-	-	V	IC=-1mA
BVEBO	-5	-	-	V	IE=-50uA
ICBO	-	-	-50	nA	VCB=-120V
IEBO	-	-	-50	nA	VEB=-4V
*VCE(sat)1	-	-	-0.2	V	IC=-10mA, IB=-1mA
*VCE(sat)2	-	-	-0.5	V	IC=-50mA, IB=-5mA
*VBE(sat)1	-	-	-1	V	IC=-10mA, IB=-1mA
*VBE(sat)2	-	-	-1	V	IC=-50mA, IB=-5mA
*hFE1	50	-	-	-	VCE=-5V, IC=-1mA
*hFE2	60	-	-	-	VCE=-5V, IC=-10mA
*hFE3	50	-	-	-	VCE=-5V, IC=-50mA
*hFE4	52	-	390	-	VCE=-6V, IC=-2mA
fT	100	-	-	MHz	VCE=-30V, IE=10mA, f=100MHz
Cob	-	-	6	pF	VCB=-30V, IE=0A, f=1MHz

\*Pulse Test: Pulse Width ≤380us, Duty Cycle≤2%

**Classification Of hFE4**

Rank	K	P	Q	R
Range	52~120	82~180	120~270	180~390

**Characteristic Curves**

Current Gain vs Collector Current

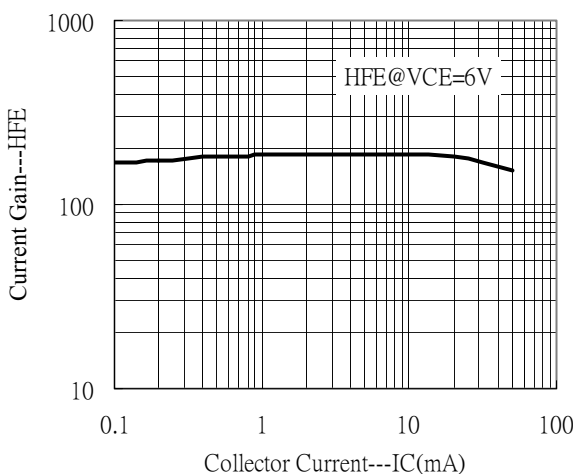

Saturation Voltage vs Collector Current

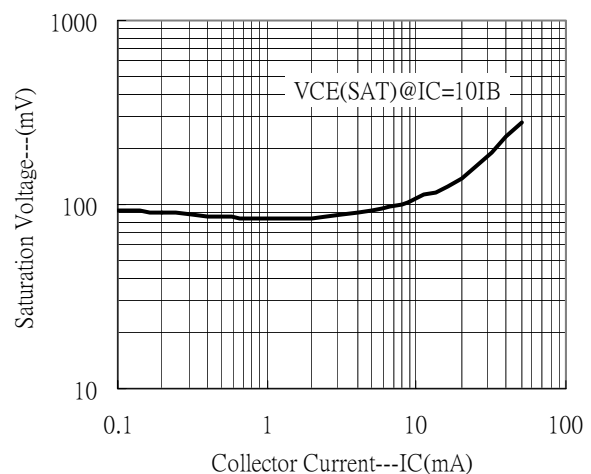



Saturation Voltage vs Collector Current

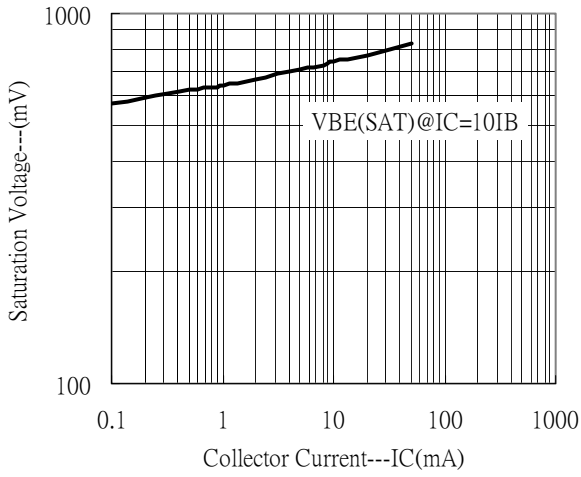

Cutoff Frequency vs Collector Current

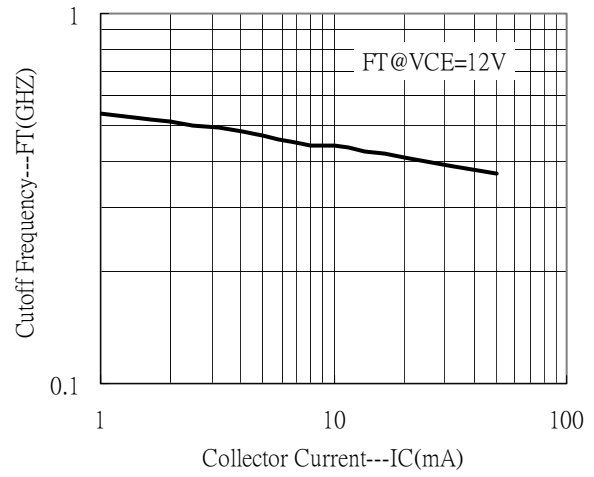

PD - Ta

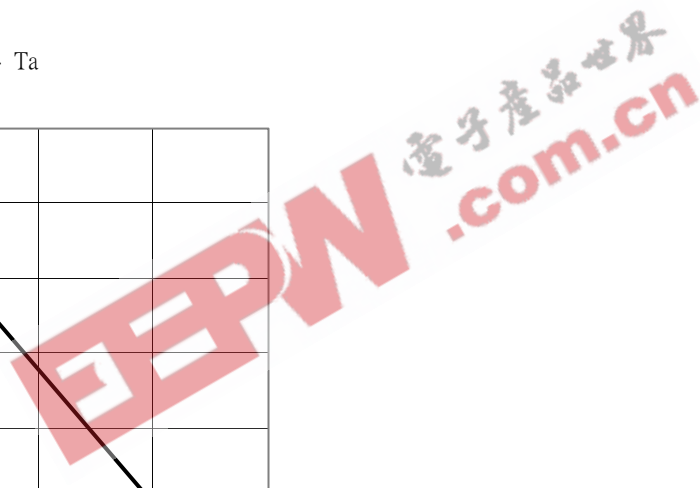
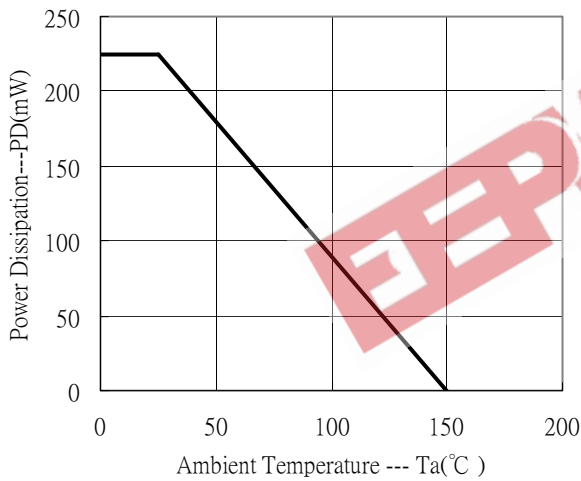

## SOT-23 Dimension

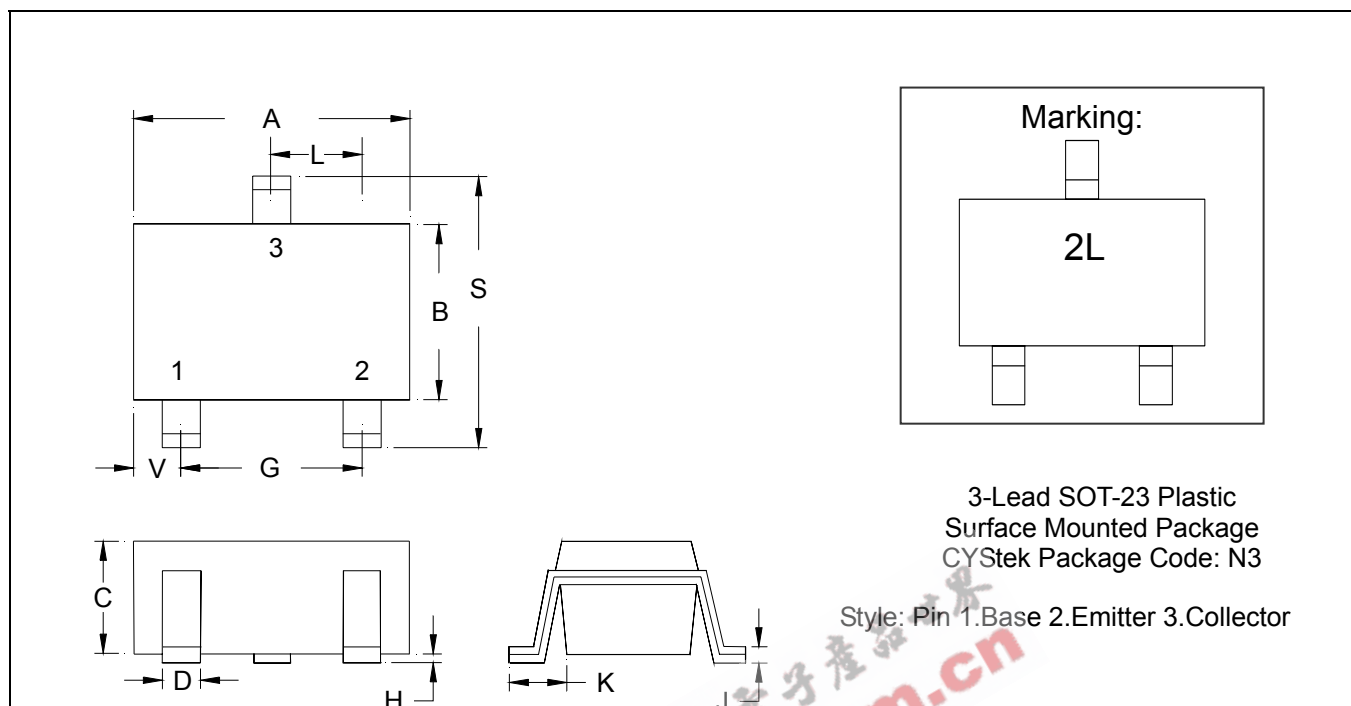

\*: Typical

DIM	Inches		Millimeters		DIM	Inches		Millimeters	
	Min.	Max.	Min.	Max.		Min.	Max.	Min.	Max.
A	0.1102	0.1204	2.80	3.04	J	0.0034	0.0070	0.085	0.177
B	0.0472	0.0630	1.20	1.60	K	0.0128	0.0266	0.32	0.67
C	0.0335	0.0512	0.89	1.30	L	0.0335	0.0453	0.85	1.15
D	0.0118	0.0197	0.30	0.50	S	0.0830	0.1083	2.10	2.75
G	0.0669	0.0910	1.70	2.30	V	0.0098	0.0256	0.25	0.65
H	0.0005	0.0040	0.013	0.10					

- Notes:**
- 1.Dimension and tolerance based on our Spec. dated Feb. 18,2002.
  - 2.Controlling dimension: millimeters.
  - 3.Maximum lead thickness includes lead finish thickness, and minimum lead thickness is the minimum thickness of base material.
  - 4.If there is any question with packing specification or packing method, please contact your local CYStek sales office.

**Material:**

- Lead: 42 Alloy ; solder plating
- Mold Compound: Epoxy resin family, flammability solid burning class: UL94V-0

**Important Notice:**

- All rights are reserved. Reproduction in whole or in part is prohibited without the prior written approval of CYStek.
- CYStek reserves the right to make changes to its products without notice.
- CYStek **semiconductor products are not warranted to be suitable for use in Life-Support Applications, or systems.**
- CYStek assumes no liability for any consequence of customer product design, infringement of patents, or application assistance.