

MINI TYPE LED LAMPS

小型化發光二極體指示

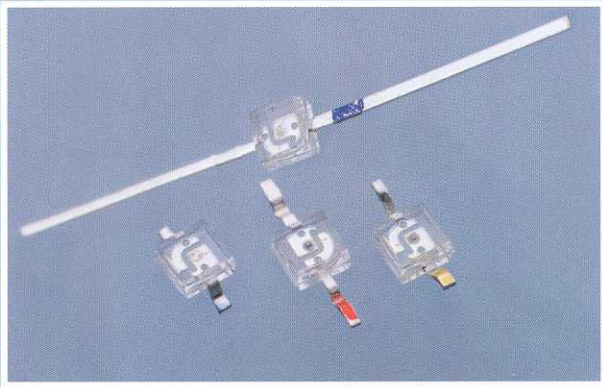

Recommended Soldering Pattern For Reflow Soldering

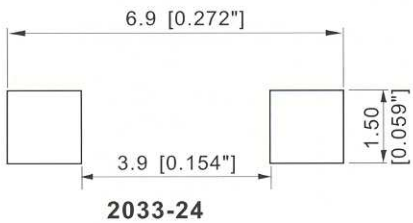
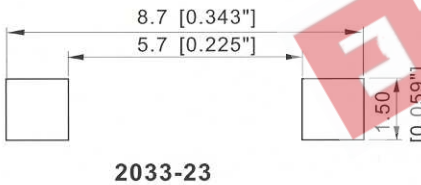
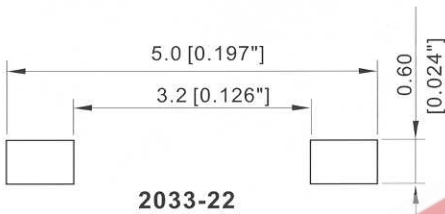

Package Outline Drawing:

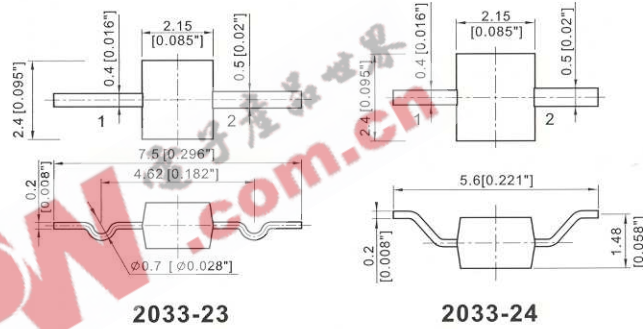
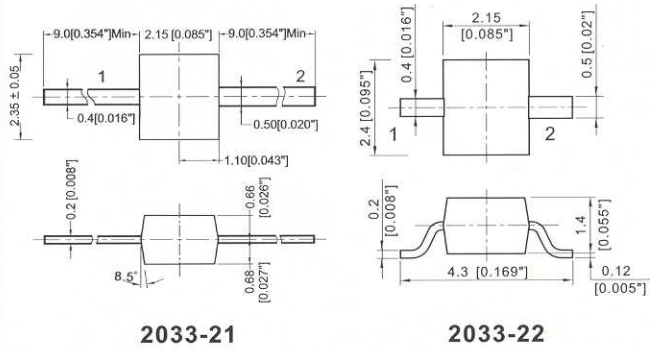

NOTES 1. All dimensions are in millimeters (inches);
2. Tolerances are ± 0.1mm (0.004inch) unless otherwise noted;
3. Resin color: water clear.

Recommended Reflow Soldering Profile.

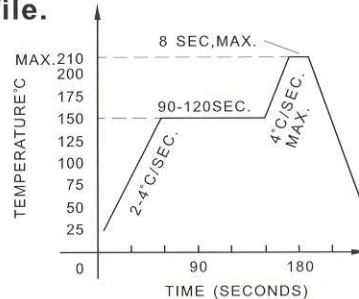

Axial Flat Top LEDs

Part Number	Raw Material	Wave Length λ D(nm)	Emitting color	Lens Type	Vf(V) Typ	Iv(mcd) Typ	Viewing angle 2 θ 1/2(°)
					At 20mA		
RF-RS2033TS-(21-24)E	GaAlAs	645	Red	Water Clear	1.8	15	135
RF-RU2033TP-(21-24)E	AlGaInP	630	Red	Water Clear	2.0	35	135
RF-OU2033TP-(21-24)E	AlGaInP	620	Orange	Water Clear	2.0	45	135
RF-YU2033TP-(21-24)E	AlGaInP	587	Yellow	Water Clear	2.0	45	135
RF-YG2033TP-(21-24)E	GaP	570	Yellow Green	Water Clear	2.3	12	135
RF-GP2033TP-(21-24)E	AlInGaN	525	Green	Water Clear	3.3	120	135
RF-BN2033TP-(21-24)E	AlInGaN	470	Blue	Water Clear	3.3	36	135
RF-WN2033TP-(21-24)E	AlInGaN		White	diffused	3.3	80	135