

**MOTOROLA
SEMICONDUCTOR
TECHNICAL DATA**

500 mW DO-35 Glass
Zener Voltage Regulator Diodes
**GENERAL DATA APPLICABLE TO ALL SERIES IN
THIS GROUP**

**500 Milliwatt
Hermetically Sealed
Glass Silicon Zener Diodes**

**GENERAL
DATA
500 mW
DO-35 GLASS**

**GLASS ZENER DIODES
500 MILLIWATTS
1.8-200 VOLTS**

Specification Features:

- Complete Voltage Range — 1.8 to 200 Volts
- DO-204AH Package — Smaller than Conventional DO-204AA Package
- Double Slug Type Construction
- Metallurgically Bonded Construction

Mechanical Characteristics:

CASE: Double slug type, hermetically sealed glass

MAXIMUM LEAD TEMPERATURE FOR SOLDERING PURPOSES: 230°C, 1/16" from case for 10 seconds

FINISH: All external surfaces are corrosion resistant with readily solderable leads

POLARITY: Cathode indicated by color band. When operated in zener mode, cathode will be positive with respect to anode

MOUNTING POSITION: Any

WAFER FAB LOCATION: Phoenix, Arizona

ASSEMBLY/TEST LOCATION: Seoul, Korea

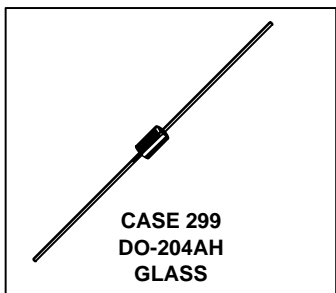

MAXIMUM RATINGS (Motorola Devices)*

Rating	Symbol	Value	Unit
DC Power Dissipation and $T_L \leq 75^\circ\text{C}$ Lead Length = 3/8" Derate above $T_L = 75^\circ\text{C}$	P_D	500 4	mW mW/°C
Operating and Storage Temperature Range	T_J, T_{stg}	-65 to +200	°C

* Some part number series have lower JEDEC registered ratings.

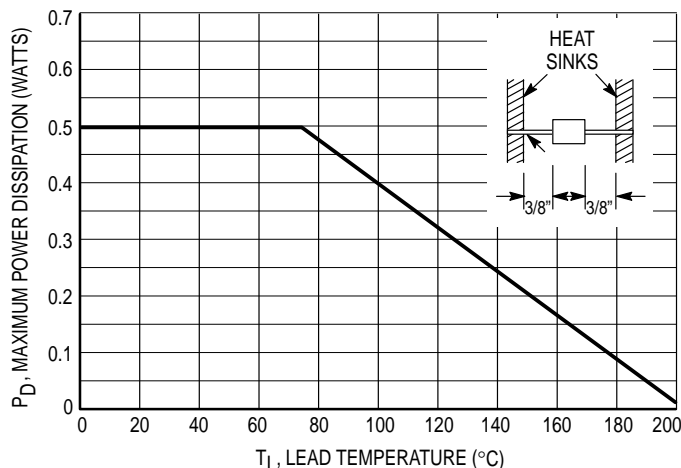

Figure 1. Steady State Power Derating

GENERAL DATA — 500 mW DO-35 GLASS

APPLICATION NOTE — ZENER VOLTAGE

Since the actual voltage available from a given zener diode is temperature dependent, it is necessary to determine junction temperature under any set of operating conditions in order to calculate its value. The following procedure is recommended:

Lead Temperature, T_L , should be determined from:

$$T_L = \theta_{LA} P_D + T_A.$$

θ_{LA} is the lead-to-ambient thermal resistance ($^{\circ}\text{C}/\text{W}$) and P_D is the power dissipation. The value for θ_{LA} will vary and depends on the device mounting method. θ_{LA} is generally 30 to 40 $^{\circ}\text{C}/\text{W}$ for the various clips and tie points in common use and for printed circuit board wiring.

The temperature of the lead can also be measured using a thermocouple placed on the lead as close as possible to the tie point. The thermal mass connected to the tie point is normally large enough so that it will not significantly respond to heat surges generated in the diode as a result of pulsed operation once steady-state conditions are achieved. Using the measured value of T_L , the junction temperature may be determined by:

$$T_J = T_L + \Delta T_{JL}.$$

ΔT_{JL} is the increase in junction temperature above the lead temperature and may be found from Figure 2 for dc power:

$$\Delta T_{JL} = \theta_{JL} P_D.$$

For worst-case design, using expected limits of I_Z , limits of P_D and the extremes of T_J (ΔT_J) may be estimated. Changes in voltage, V_Z , can then be found from:

$$\Delta V = \theta_{VZ} T_J.$$

θ_{VZ} , the zener voltage temperature coefficient, is found from Figures 4 and 5.

Under high power-pulse operation, the zener voltage will vary with time and may also be affected significantly by the zener resistance. For best regulation, keep current excursions as low as possible.

Surge limitations are given in Figure 7. They are lower than would be expected by considering only junction temperature, as current crowding effects cause temperatures to be extremely high in small spots, resulting in device degradation should the limits of Figure 7 be exceeded.

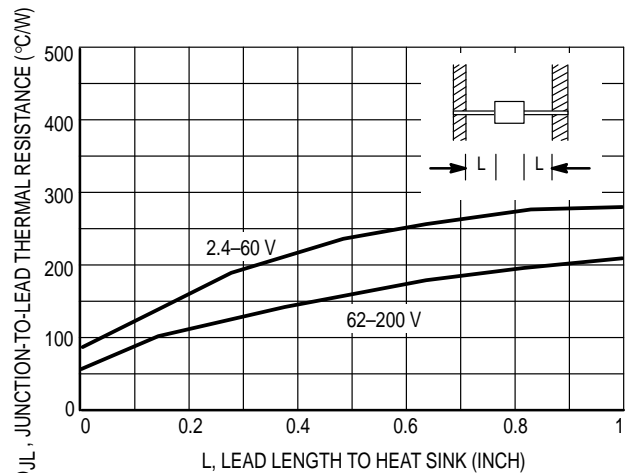

Figure 2. Typical Thermal Resistance

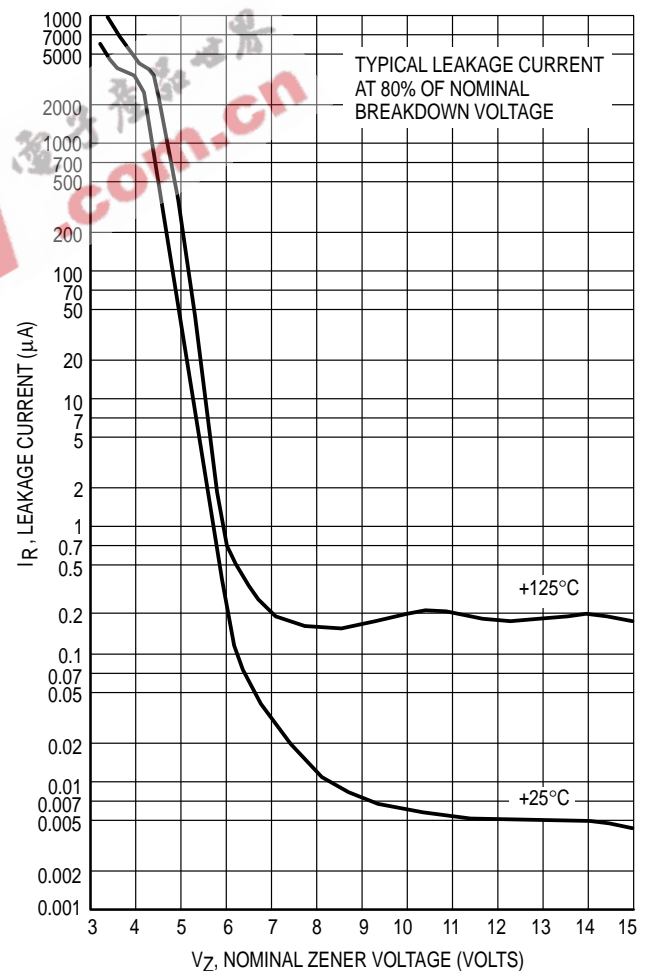

Figure 3. Typical Leakage Current

GENERAL DATA — 500 mW DO-35 GLASS

TEMPERATURE COEFFICIENTS

(-55°C to +150°C temperature range; 90% of the units are in the ranges indicated.)

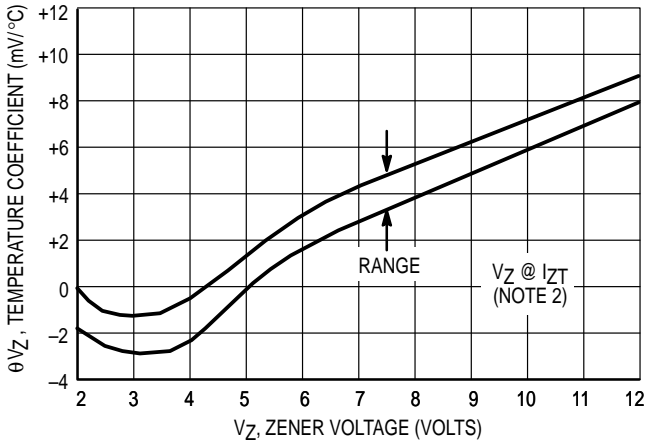

Figure 4a. Range for Units to 12 Volts

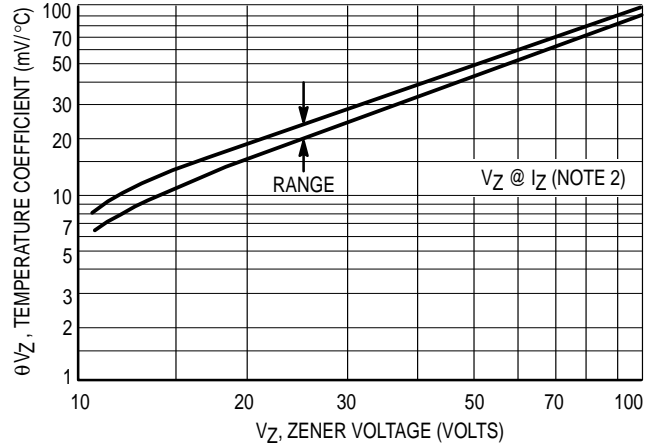

Figure 4b. Range for Units 12 to 100 Volts

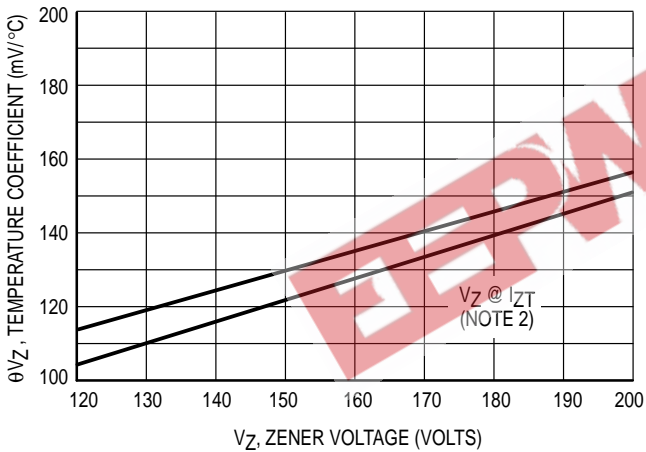

Figure 4c. Range for Units 120 to 200 Volts

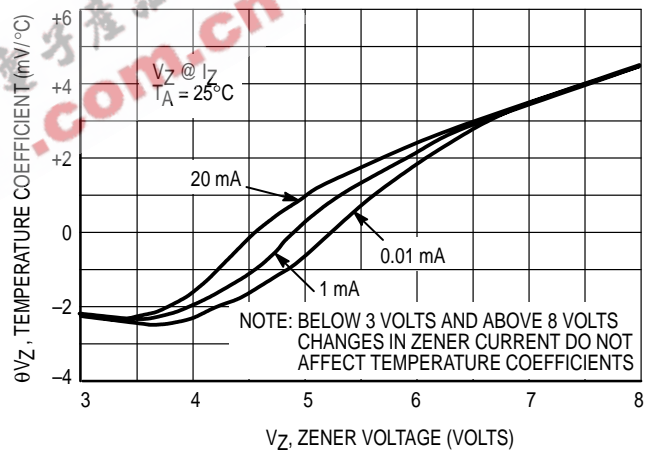

Figure 5. Effect of Zener Current

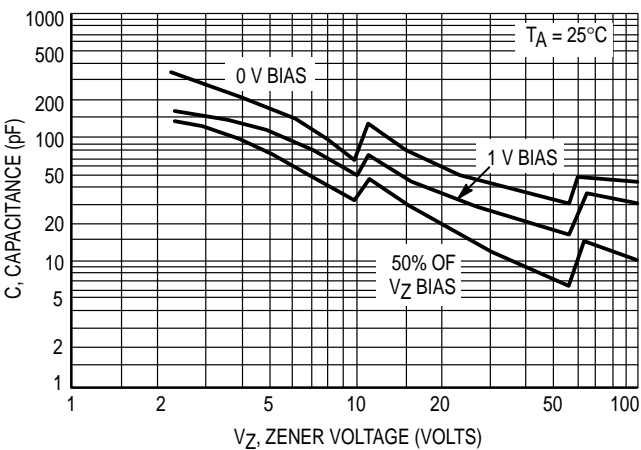

Figure 6a. Typical Capacitance 2.4-100 Volts

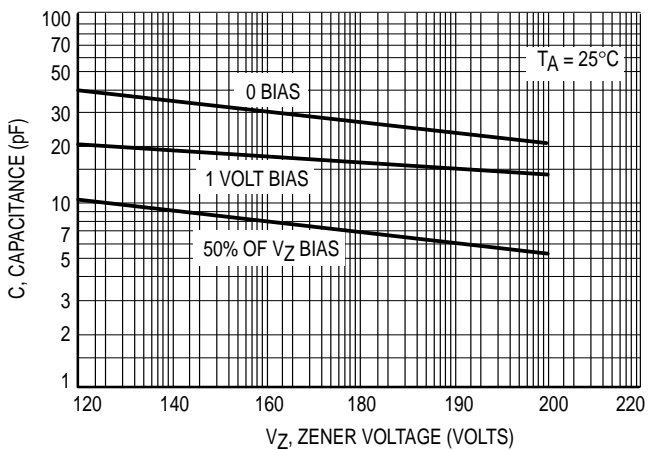

Figure 6b. Typical Capacitance 120-200 Volts

GENERAL DATA — 500 mW DO-35 GLASS

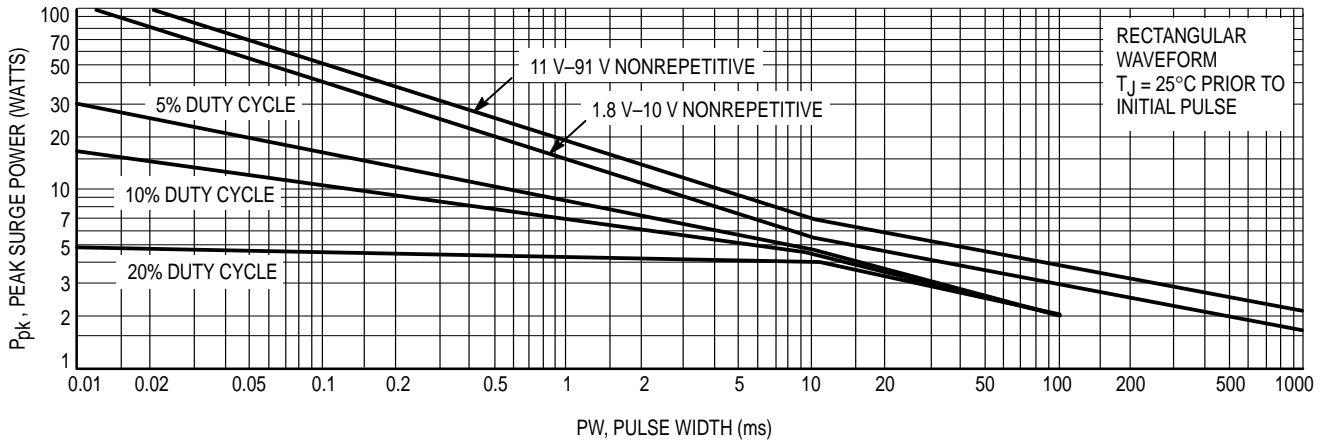

Figure 7a. Maximum Surge Power 1.8-91 Volts

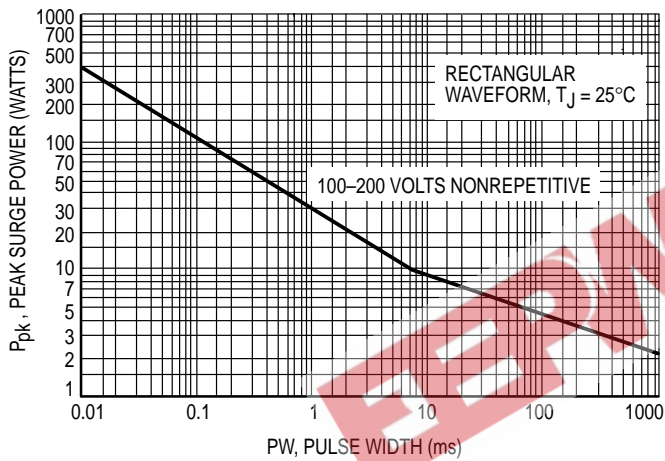

Figure 7b. Maximum Surge Power DO-204AH 100-200 Volts

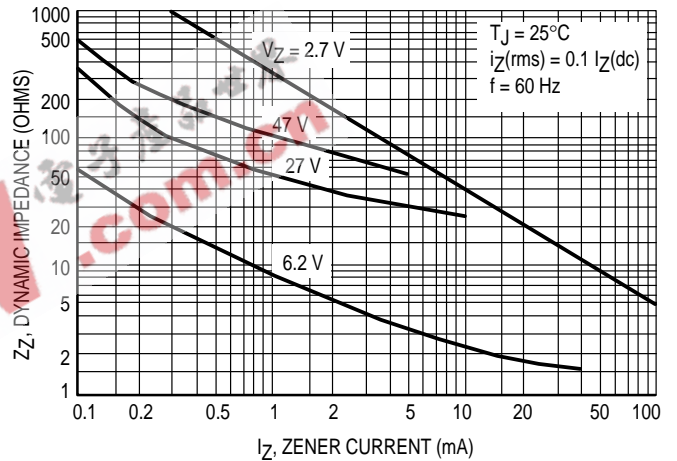

Figure 8. Effect of Zener Current on Zener Impedance

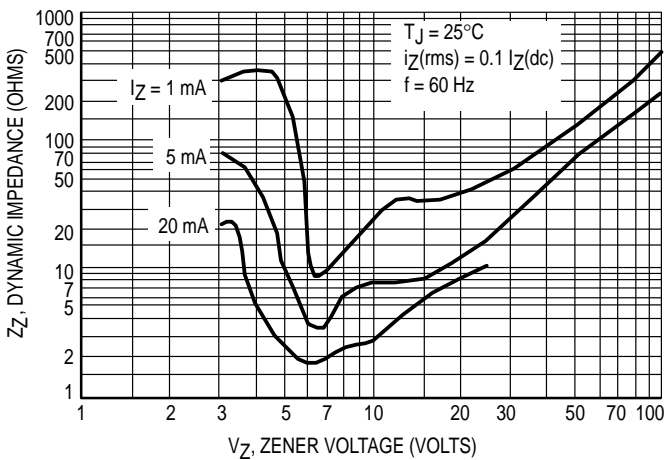

Figure 9. Effect of Zener Voltage on Zener Impedance

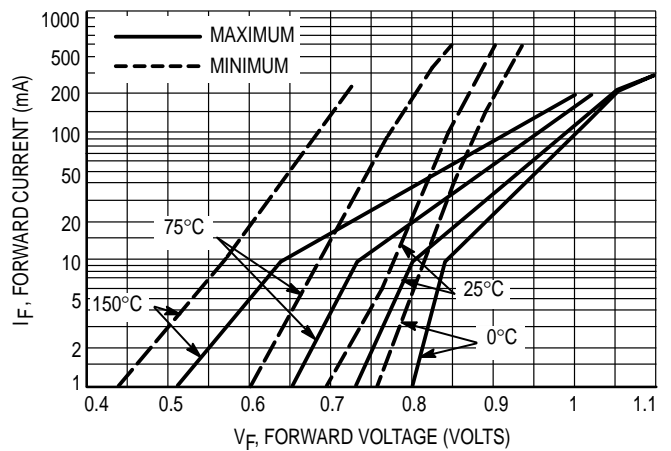

Figure 10. Typical Forward Characteristics

GENERAL DATA — 500 mW DO-35 GLASS

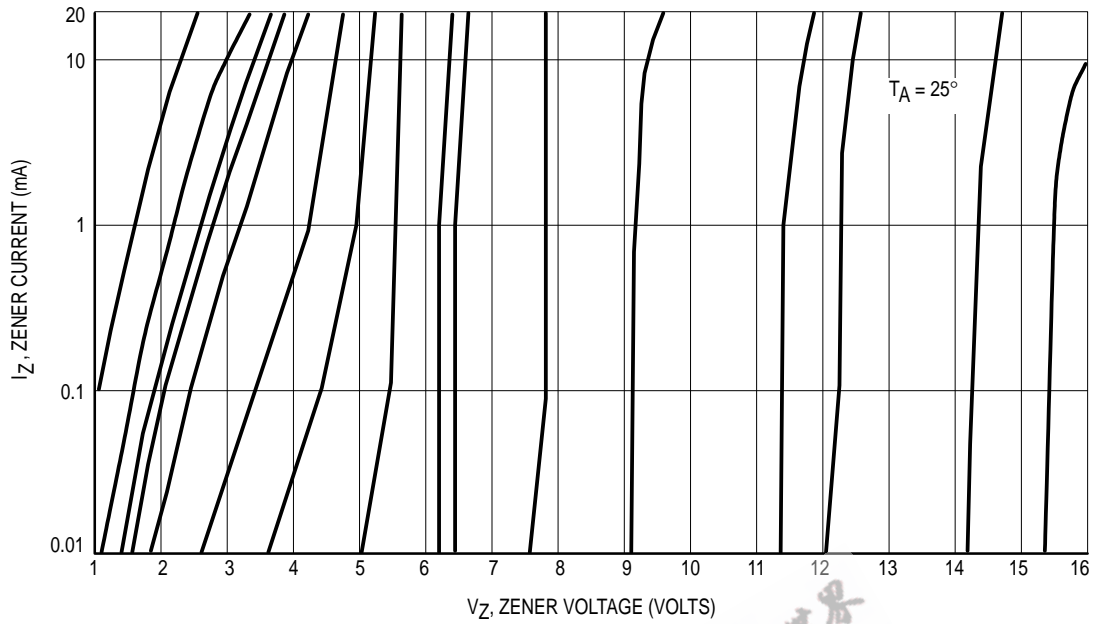

Figure 11. Zener Voltage versus Zener Current — $V_Z = 1$ thru 16 Volts

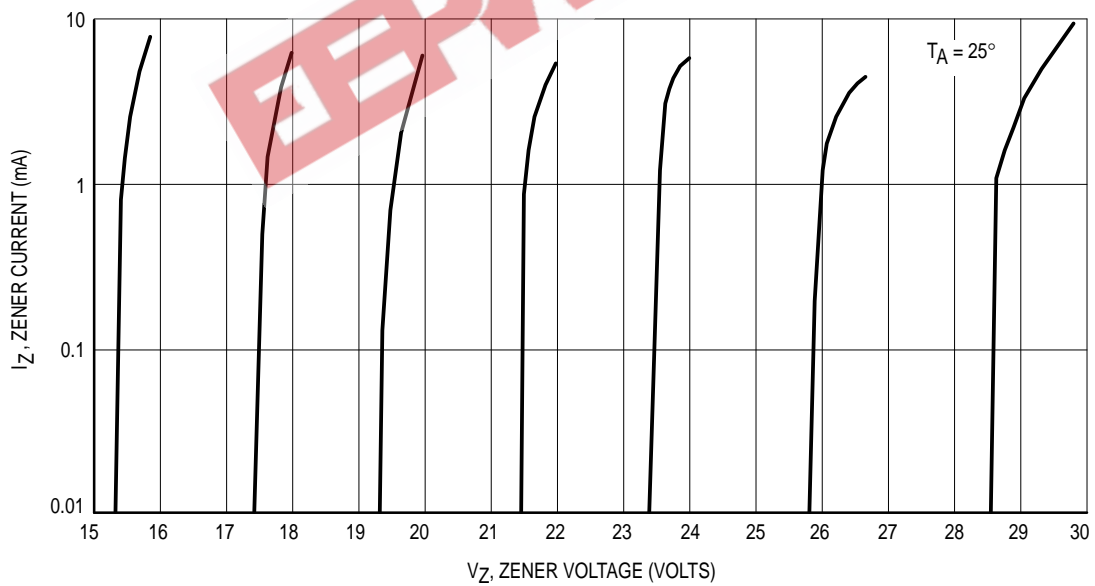

Figure 12. Zener Voltage versus Zener Current — $V_Z = 15$ thru 30 Volts

GENERAL DATA — 500 mW DO-35 GLASS

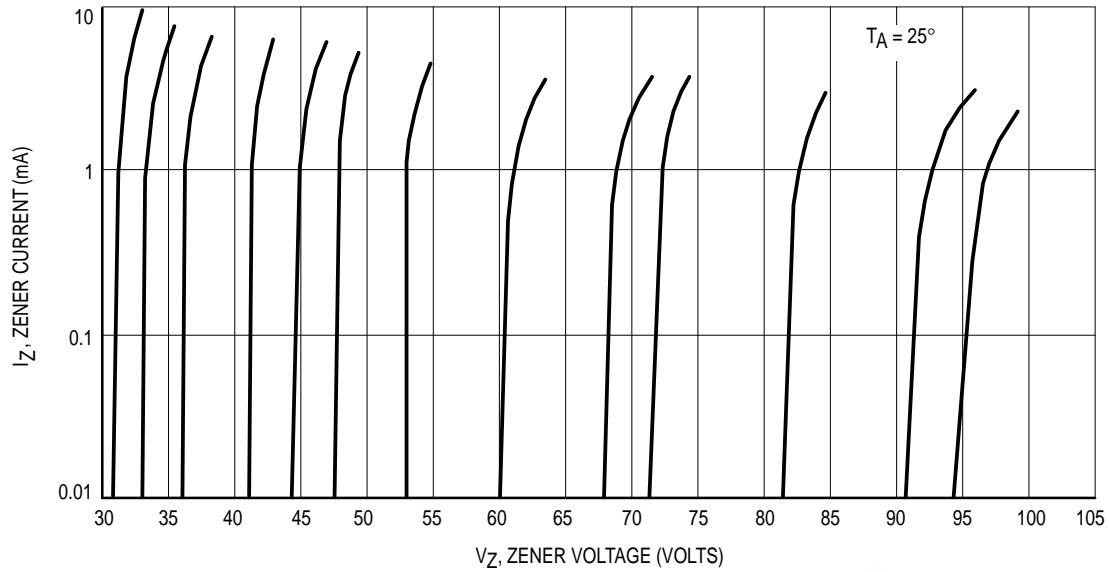

Figure 13. Zener Voltage versus Zener Current — $V_Z = 30$ thru 105 Volts

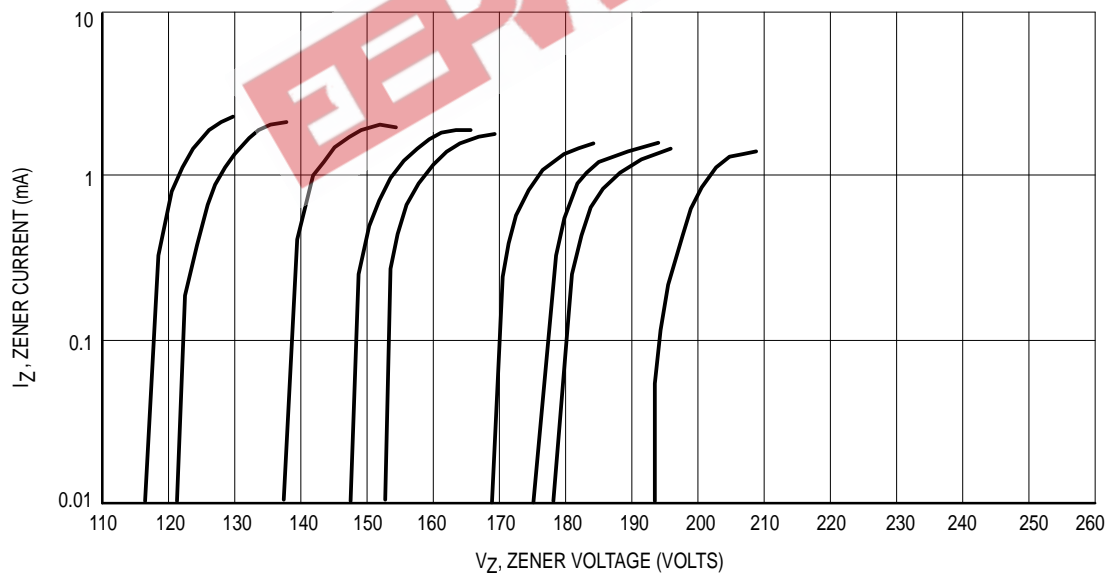

Figure 14. Zener Voltage versus Zener Current — $V_Z = 110$ thru 220 Volts

GENERAL DATA — 500 mW DO-35 GLASS

ELECTRICAL CHARACTERISTICS ($T_A = 25^\circ\text{C}$, $V_F = 1.5\text{ V}$ Max at 200 mA for all types)

Type Number (Note 1)	Nominal Zener Voltage V_Z @ I_{ZT} (Note 2) Volts	Test Current I_{ZT} mA	Maximum Zener Impedance Z_{ZT} @ I_{ZT} (Note 3) Ohms	Maximum DC Zener Current I_{ZM} (Note 4) mA	Maximum Reverse Leakage Current	
					$T_A = 25^\circ\text{C}$ I_R @ $V_R = 1\text{ V}$ μA	$T_A = 150^\circ\text{C}$ I_R @ $V_R = 1\text{ V}$ μA
1N4370A	2.4	20	30	150	100	200
1N4371A	2.7	20	30	135	75	150
1N4372A	3	20	29	120	50	100
1N746A	3.3	20	28	110	10	30
1N747A	3.6	20	24	100	10	30
1N748A	3.9	20	23	95	10	30
1N749A	4.3	20	22	85	2	30
1N750A	4.7	20	19	75	2	30
1N751A	5.1	20	17	70	1	20
1N752A	5.6	20	11	65	1	20
1N753A	6.2	20	7	60	0.1	20
1N754A	6.8	20	5	55	0.1	20
1N755A	7.5	20	6	50	0.1	20
1N756A	8.2	20	8	45	0.1	20
1N757A	9.1	20	10	40	0.1	20
1N758A	10	20	17	35	0.1	20
1N759A	12	20	30	30	0.1	20

Type Number (Note 1)	Nominal Zener Voltage V_Z (Note 2) Volts	Test Current I_{ZT} mA	Maximum Zener Impedance (Note 3)			Maximum DC Zener Current I_{ZM} (Note 4) mA	Maximum Reverse Current	
			Z_{ZT} @ I_{ZT} Ohms	Z_{ZK} @ I_{ZK} Ohms	I_{ZK} mA		I_R Maximum μA	Test Voltage Vdc V_R
1N957B	6.8	18.5	4.5	700	1	47	150	5.2
1N958B	7.5	16.5	5.5	700	0.5	42	75	5.7
1N959B	8.2	15	6.5	700	0.5	38	50	6.2
1N960B	9.1	14	7.5	700	0.5	35	25	6.9
1N961B	10	12.5	8.5	700	0.25	32	10	7.6
1N962B	11	11.5	9.5	700	0.25	28	5	8.4
1N963B	12	10.5	11.5	700	0.25	26	5	9.1
1N964B	13	9.5	13	700	0.25	24	5	9.9
1N965B	15	8.5	16	700	0.25	21	5	11.4
1N966B	16	7.8	17	700	0.25	19	5	12.2
1N967B	18	7	21	750	0.25	17	5	13.7
1N968B	20	6.2	25	750	0.25	15	5	15.2
1N969B	22	5.6	29	750	0.25	14	5	16.7
1N970B	24	5.2	33	750	0.25	13	5	18.2
1N971B	27	4.6	41	750	0.25	11	5	20.6
1N972B	30	4.2	49	1000	0.25	10	5	22.8
1N973B	33	3.8	58	1000	0.25	9.2	5	25.1
1N974B	36	3.4	70	1000	0.25	8.5	5	27.4
1N975B	39	3.2	80	1000	0.25	7.8	5	29.7
1N976B	43	3	93	1500	0.25	7	5	32.7
1N977B	47	2.7	105	1500	0.25	6.4	5	35.8
1N978B	51	2.5	125	1500	0.25	5.9	5	38.8
1N979B	56	2.2	150	2000	0.25	5.4	5	42.6
1N980B	62	2	185	2000	0.25	4.9	5	47.1

GENERAL DATA — 500 mW DO-35 GLASS

Type Number (Note 1)	Nominal Zener Voltage V_Z (Note 2) Volts	Test Current I_{ZT} mA	Maximum Zener Impedance (Note 3)			Maximum DC Zener Current I_{ZM} (Note 4) mA	Maximum Reverse Leakage Current	
			Z_{ZT} @ I_{ZT} Ohms	Z_{ZK} @ I_{ZK} Ohms	I_{ZK} mA		I_R Maximum μA	Test Voltage Vdc V_R
1N981B	68	1.8	230	2000	0.25	4.5	5	51.7
1N982B	75	1.7	270	2000	0.25	4.1	5	56
1N983B	82	1.5	330	3000	0.25	3.7	5	62.2
1N984B	91	1.4	400	3000	0.25	3.3	5	69.2
1N985B	100	1.3	500	3000	0.25	3	5	76
1N986B	110	1.1	750	4000	0.25	2.7	5	83.6
1N987B	120	1	900	4500	0.25	2.5	5	91.2
1N988B	130	0.95	1100	5000	0.25	2.3	5	98.8
1N989B	150	0.85	1500	6000	0.25	2	5	114
1N990B	160	0.8	1700	6500	0.25	1.9	5	121.6
1N991B	180	0.68	2200	7100	0.25	1.7	5	136.8
1N992B	200	0.65	2500	8000	0.25	1.5	5	152

NOTE 1. TOLERANCE AND VOLTAGE DESIGNATION

Tolerance Designation

The type numbers shown have tolerance designations as follows:

1N4370A series: $\pm 5\%$ units, C for $\pm 2\%$, D for $\pm 1\%$.

1N746A series: $\pm 5\%$ units, C for $\pm 2\%$, D for $\pm 1\%$.

1N957B series: $\pm 5\%$ units, C for $\pm 2\%$, D for $\pm 1\%$.

NOTE 2. ZENER VOLTAGE (V_Z) MEASUREMENT

Nominal zener voltage is measured with the device junction in thermal equilibrium at the lead temperature of $30^\circ\text{C} \pm 1^\circ\text{C}$ and $3/8"$ lead length.

NOTE 3. ZENER IMPEDANCE (Z_Z) DERIVATION

Z_{ZT} and Z_{ZK} are measured by dividing the ac voltage drop across the device by the ac current applied. The specified limits are for $I_Z(\text{ac}) = 0.1 I_Z(\text{dc})$ with the ac frequency = 60 Hz.

NOTE 4. MAXIMUM ZENER CURRENT RATINGS (I_{ZM})

Values shown are based on the JEDEC rating of 400 mW. Where the actual zener voltage (V_Z) is known at the operating point, the maximum zener current may be increased and is limited by the derating curve.



GENERAL DATA — 500 mW DO-35 GLASS

Low level oxide passivated zener diodes for applications requiring extremely low operating currents, low leakage, and sharp breakdown voltage.

- Zener Voltage Specified @ $I_{ZT} = 50 \mu\text{A}$
- Maximum Delta V_Z Given from 10 to 100 μA

ELECTRICAL CHARACTERISTICS ($T_A = 25^\circ\text{C}$, $V_F = 1.5 \text{ V Max}$ at $I_F = 100 \text{ mA}$ for all types)

Type Number (Note 1)	Zener Voltage V_Z @ $I_{ZT} = 50 \mu\text{A}$ Volts			Maximum Reverse Current $I_R \mu\text{A}$ (Note 3)	Test Voltage V_R Volts	Maximum Zener Current $I_{ZM} \text{ mA}$ (Note 2)	Maximum Voltage Change ΔV_Z Volts (Note 4)
	Nom (Note 1)	Min	Max				
1N4678	1.8	1.71	1.89	7.5	1	120	0.7
1N4679	2	1.9	2.1	5	1	110	0.7
1N4680	2.2	2.09	2.31	4	1	100	0.75
1N4681	2.4	2.28	2.52	2	1	95	0.8
1N4682	2.7	2.565	2.835	1	1	90	0.85
1N4683	3	2.85	3.15	0.8	1	85	0.9
1N4684	3.3	3.135	3.465	7.5	1.5	80	0.95
1N4685	3.6	3.42	3.78	7.5	2	75	0.95
1N4686	3.9	3.705	4.095	5	2	70	0.97
1N4687	4.3	4.085	4.515	4	2	65	0.99
1N4688	4.7	4.465	4.935	10	3	60	0.99
1N4689	5.1	4.845	5.355	10	3	55	0.97
1N4690	5.6	5.32	5.88	10	4	50	0.96
1N4691	6.2	5.89	6.51	10	5	45	0.95
1N4692	6.8	6.46	7.14	10	5.1	35	0.9
1N4693	7.5	7.125	7.875	10	5.7	31.8	0.75
1N4694	8.2	7.79	8.61	1	6.2	29	0.5
1N4695	8.7	8.265	9.135	1	6.6	27.4	0.1
1N4696	9.1	8.645	9.555	1	6.9	26.2	0.08
1N4697	10	9.5	10.5	1	7.6	24.8	0.1
1N4698	11	10.45	11.55	0.05	8.4	21.6	0.11
1N4699	12	11.4	12.6	0.05	9.1	20.4	0.12
1N4700	13	12.35	13.65	0.05	9.8	19	0.13
1N4701	14	13.3	14.7	0.05	10.6	17.5	0.14
1N4702	15	14.25	15.75	0.05	11.4	16.3	0.15
1N4703	16	15.2	16.8	0.05	12.1	15.4	0.16
1N4704	17	16.15	17.85	0.05	12.9	14.5	0.17
1N4705	18	17.1	18.9	0.05	13.6	13.2	0.18
1N4706	19	18.05	19.95	0.05	14.4	12.5	0.19
1N4707	20	19	21	0.01	15.2	11.9	0.2
1N4708	22	20.9	23.1	0.01	16.7	10.8	0.22
1N4709	24	22.8	25.2	0.01	18.2	9.9	0.24
1N4710	25	23.75	26.25	0.01	19	9.5	0.25
1N4711	27	25.65	28.35	0.01	20.4	8.8	0.27
1N4712	28	26.6	29.4	0.01	21.2	8.5	0.28
1N4713	30	28.5	31.5	0.01	22.8	7.9	0.3
1N4714	33	31.35	34.65	0.01	25	7.2	0.33
1N4715	36	34.2	37.8	0.01	27.3	6.6	0.36
1N4716	39	37.05	40.95	0.01	29.6	6.1	0.39
1N4717	43	40.85	45.15	0.01	32.6	5.5	0.43

NOTE 1. TOLERANCE AND VOLTAGE DESIGNATION (V_Z)

The type numbers shown have a standard tolerance of $\pm 5\%$ on the nominal Zener voltage, C for $\pm 2\%$, D for $\pm 1\%$.

NOTE 2. MAXIMUM ZENER CURRENT RATINGS (I_{ZM})

Maximum Zener current ratings are based on maximum Zener voltage of the individual units and JEDEC 250 mW rating.

NOTE 3. REVERSE LEAKAGE CURRENT (I_R)

Reverse leakage currents are guaranteed and measured at V_R as shown on the table.

NOTE 4. MAXIMUM VOLTAGE CHANGE (ΔV_Z)

Voltage change is equal to the difference between V_Z at 100 μA and V_Z at 10 μA .

NOTE 5. ZENER VOLTAGE (V_Z) MEASUREMENT

Nominal Zener voltage is measured with the device junction in thermal equilibrium at the lead temperature at $30^\circ\text{C} \pm 1^\circ\text{C}$ and 3/8" lead length.

GENERAL DATA — 500 mW DO-35 GLASS

ELECTRICAL CHARACTERISTICS ($T_A = 25^\circ\text{C}$ unless otherwise noted. Based on dc measurements at thermal equilibrium; lead length = 3/8"; thermal resistance of heat sink = 30°C/W) $V_F = 1.1$ Max @ $I_F = 200$ mA for all types.

JEDEC Type No. (Note 1)	Nominal Zener Voltage V_Z @ I_{ZT} Volts (Note 3)	Test Current I_{ZT} mA	Max Zener Impedance (Note 4)		Max Reverse Leakage Current		Max Zener Voltage Temperature Coeff. θ_{VZ} (%/°C) (Note 2)
			Z_{ZT} @ I_{ZT} Ohms	Z_{ZK} @ $I_{ZK} = 0.25$ mA Ohms	I_R μA	V_R Volts	
1N5221B	2.4	20	30	1200	100	1	-0.085
1N5222B	2.5	20	30	1250	100	1	-0.085
1N5223B	2.7	20	30	1300	75	1	-0.08
1N5224B	2.8	20	30	1400	75	1	-0.08
1N5225B	3	20	29	1600	50	1	-0.075
1N5226B	3.3	20	28	1600	25	1	-0.07
1N5227B	3.6	20	24	1700	15	1	-0.065
1N5228B	3.9	20	23	1900	10	1	-0.06
1N5229B	4.3	20	22	2000	5	1	± 0.055
1N5230B	4.7	20	19	1900	5	2	± 0.03
1N5231B	5.1	20	17	1600	5	2	± 0.03
1N5232B	5.6	20	11	1600	5	3	+0.038
1N5233B	6	20	7	1600	5	3.5	+0.038
1N5234B	6.2	20	7	1000	5	4	+0.045
1N5235B	6.8	20	5	750	3	5	+0.05
1N5236B	7.5	20	6	500	3	6	+0.058
1N5237B	8.2	20	8	500	3	6.5	+0.062
1N5238B	8.7	20	8	600	3	6.5	+0.065
1N5239B	9.1	20	10	600	3	7	+0.068
1N5240B	10	20	17	600	3	8	+0.075
1N5241B	11	20	22	600	2	8.4	+0.076
1N5242B	12	20	30	600	1	9.1	+0.077
1N5243B	13	9.5	13	600	0.5	9.9	+0.079
1N5244B	14	9	15	600	0.1	10	+0.082
1N5245B	15	8.5	16	600	0.1	11	+0.082
1N5246B	16	7.8	17	600	0.1	12	+0.083
1N5247B	17	7.4	19	600	0.1	13	+0.084
1N5248B	18	7	21	600	0.1	14	+0.085
1N5249B	19	6.6	23	600	0.1	14	+0.086
1N5250B	20	6.2	25	600	0.1	15	+0.086
1N5251B	22	5.6	29	600	0.1	17	+0.087
1N5252B	24	5.2	33	600	0.1	18	+0.088
1N5253B	25	5	35	600	0.1	19	+0.089
1N5254B	27	4.6	41	600	0.1	21	+0.09
1N5255B	28	4.5	44	600	0.1	21	+0.091
1N5256B	30	4.2	49	600	0.1	23	+0.091
1N5257B	33	3.8	58	700	0.1	25	+0.092
1N5258B	36	3.4	70	700	0.1	27	+0.093
1N5259B	39	3.2	80	800	0.1	30	+0.094
1N5260B	43	3	93	900	0.1	33	+0.095
1N5261B	47	2.7	105	1000	0.1	36	+0.095
1N5262B	51	2.5	125	1100	0.1	39	+0.096
1N5263B	56	2.2	150	1300	0.1	43	+0.096
1N5264B	60	2.1	170	1400	0.1	46	+0.097
1N5265B	62	2	185	1400	0.1	47	+0.097

(continued)

GENERAL DATA — 500 mW DO-35 GLASS

ELECTRICAL CHARACTERISTICS — continued ($T_A = 25^\circ\text{C}$ unless otherwise noted. Based on dc measurements at thermal equilibrium; lead length = 3/8"; thermal resistance of heat sink = 30°C/W) $V_F = 1.1$ Max @ $I_F = 200$ mA for all types.

JEDEC Type No. (Note 1)	Nominal Zener Voltage V_Z @ I_{ZT} Volts (Note 3)	Test Current I_{ZT} mA	Max Zener Impedance (Note 4)		Max Reverse Leakage Current		Max Zener Voltage Temperature Coeff. θ_{VZ} (%/°C) (Note 2)
			Z_{ZT} @ I_{ZT} Ohms	Z_{ZK} @ $I_{ZK} = 0.25$ mA Ohms	I_R μA	V_R Volts	
1N5266B	68	1.8	230	1600	0.1	52	+0.097
1N5267B	75	1.7	270	1700	0.1	56	+0.098
1N5268B	82	1.5	330	2000	0.1	62	+0.098
1N5269B	87	1.4	370	2200	0.1	68	+0.099
1N5270B	91	1.4	400	2300	0.1	69	+0.099
1N5271B	100	1.3	500	2600	0.1	76	+0.11
1N5272B	110	1.1	750	3000	0.1	84	+0.11
1N5273B	120	1	900	4000	0.1	91	+0.11
1N5274B	130	0.95	1100	4500	0.1	99	+0.11
1N5275B	140	0.9	1300	4500	0.1	106	+0.11
1N5276B	150	0.85	1500	5000	0.1	114	+0.11
1N5277B	160	0.8	1700	5500	0.1	122	+0.11
1N5278B	170	0.74	1900	5500	0.1	129	+0.11
1N5279B	180	0.68	2200	6000	0.1	137	+0.11
1N5280B	190	0.66	2400	6500	0.1	144	+0.11
1N5281B	200	0.65	2500	7000	0.1	152	+0.11

NOTE 1. TOLERANCE

The JEDEC type numbers shown indicate a tolerance of $\pm 5\%$. For tighter tolerance devices use suffixes "C" for $\pm 2\%$ and "D" for $\pm 1\%$.

NOTE 2. TEMPERATURE COEFFICIENT (θ_{VZ})[†]

Test conditions for temperature coefficient are as follows:

- a. $I_{ZT} = 7.5$ mA, $T_1 = 25^\circ\text{C}$,
 $T_2 = 125^\circ\text{C}$ (1N5221B through 1N5242B).
- b. $I_{ZT} = \text{Rated } I_{ZT}$, $T_1 = 25^\circ\text{C}$,
 $T_2 = 125^\circ\text{C}$ (1N5243B through 1N5281B).

Device to be temperature stabilized with current applied prior to reading breakdown voltage at the specified ambient temperature.

NOTE 3. ZENER VOLTAGE (V_Z) MEASUREMENT

Nominal zener voltage is measured with the device junction in thermal equilibrium at the lead temperature of $30^\circ\text{C} \pm 1^\circ\text{C}$ and 3/8" lead length.

NOTE 4. ZENER IMPEDANCE (Z_Z) DERIVATION

Z_{ZT} and Z_{ZK} are measured by dividing the ac voltage drop across the device by the ac current applied. The specified limits are for $I_{Z(ac)} = 0.1 I_{Z(dc)}$ with the ac frequency = 60 Hz.

[†] For more information on special selections contact your nearest Motorola representative.

GENERAL DATA — 500 mW DO-35 GLASS

*ELECTRICAL CHARACTERISTICS ($T_L = 30^\circ\text{C}$ unless otherwise noted.) ($V_F = 1.5$ Volts Max @ $I_F = 100$ mAdc for all types.)

Motorola Type Number (Note 1)	Nominal Zener Voltage V_Z @ I_{ZT} Volts (Note 4)	Test Current I_{ZT} mA	Max Zener Impedance (Note 3)		Max Reverse Leakage Current		Max DC Zener Current I_{ZM} (Note 2)
			Z_{ZT} @ I_{ZT} Ohms	Z_{ZK} @ $I_{ZK} = 0.25$ mA	I_R μA	@ V_R Volts	
1N5985B	2.4	5	100	1800	100	1	208
1N5986B	2.7	5	100	1900	75	1	185
1N5987B	3	5	95	2000	50	1	167
1N5988B	3.3	5	95	2200	25	1	152
1N5989B	3.6	5	90	2300	15	1	139
1N5990B	3.9	5	90	2400	10	1	128
1N5991B	4.3	5	88	2500	5	1	116
1N5992B	4.7	5	70	2200	3	1.5	106
1N5993B	5.1	5	50	2050	2	2	98
1N5994B	5.6	5	25	1800	2	3	89
1N5995B	6.2	5	10	1300	1	4	81
1N5996B	6.8	5	8	750	1	5.2	74
1N5997B	7.5	5	7	600	0.5	6	67
1N5998B	8.2	5	7	600	0.5	6.5	61
1N5999B	9.1	5	10	600	0.1	7	55
1N6000B	10	5	15	600	0.1	8	50
1N6001B	11	5	18	600	0.1	8.4	45
1N6002B	12	5	22	600	0.1	9.1	42
1N6003B	13	5	25	600	0.1	9.9	38
1N6004B	15	5	32	600	0.1	11	33
1N6005B	16	5	36	600	0.1	12	31
1N6006B	18	5	42	600	0.1	14	28
1N6007B	20	5	48	600	0.1	15	25
1N6008B	22	5	55	600	0.1	17	23
1N6009B	24	5	62	600	0.1	18	21
1N6010B	27	5	70	600	0.1	21	19
1N6011B	30	5	78	600	0.1	23	17
1N6012B	33	5	88	700	0.1	25	15
1N6013B	36	5	95	700	0.1	27	14
1N6014B	39	2	130	800	0.1	30	13
1N6015B	43	2	150	900	0.1	33	12
1N6016B	47	2	170	1000	0.1	36	11
1N6017B	51	2	180	1300	0.1	39	9.8
1N6018B	56	2	200	1400	0.1	43	8.9
1N6019B	62	2	225	1400	0.1	47	8
1N6020B	68	2	240	1600	0.1	52	7.4
1N6021B	75	2	265	1700	0.1	56	6.7
1N6022B	82	2	280	2000	0.1	62	6.1
1N6023B	91	2	300	2300	0.1	69	5.5
1N6024B	100	1	500	2600	0.1	76	5
1N6025B	110	1	650	3000	0.1	84	4.5

*Indicates JEDEC Registered Data

NOTE 1. TOLERANCE AND VOLTAGE DESIGNATION

Tolerance designation — Device tolerances of $\pm 5\%$ are indicated by a "B" suffix, $\pm 2\%$ by a "C" suffix, $\pm 1\%$ by a "D" suffix.

NOTE 2.

This data was calculated using nominal voltages. The maximum current handling capability on a worst case basis is limited by the actual zener voltage at the operating point and the power derating curve.

NOTE 3.

Z_{ZT} and Z_{ZK} are measured by dividing the ac voltage drop across the device by the ac current applied. The specified limits are for $I_Z(\text{ac}) = 0.1$ $I_Z(\text{dc})$ with the ac frequency = 1.0 kHz.

NOTE 4.

Nominal Zener Voltage (V_Z) is measured with the device junction in thermal equilibrium at the lead temperature of $30^\circ\text{C} \pm 1^\circ\text{C}$ and 3/8" lead length.

GENERAL DATA — 500 mW DO-35 GLASS

ELECTRICAL CHARACTERISTICS ($T_L = 30^\circ\text{C}$ unless otherwise noted.) ($V_F = 1.3$ Volts Max, $I_F = 100$ mAdc for all types.)

Motorola Type Number	V_{ZT} at I_{ZT} (V)		Max Zener Impedance (Note 3) Z_{ZT} @ I_{ZT} (Ohms) Max	I_{ZT} (mA)	Max Reverse Leakage Current I_R at V_R (μA)		V_R (V)	I_{ZM} (mA) (Note 2)
	Min (Note 1)	Max (Note 1)			T_{amb} 25°C Max	T_{amb} 125°C Max		
BZX55C2V4RL	2.28	2.56	85	5	50	100	1	155
BZX55C2V7RL	2.5	2.9	85	5	10	50	1	135
BZX55C3V0RL	2.8	3.2	85	5	4	40	1	125
BZX55C3V3RL	3.1	3.5	85	5	2	40	1	115
BZX55C3V6RL	3.4	3.8	85	5	2	40	1	105
BZX55C3V9RL	3.7	4.1	85	5	2	40	1	95
BZX55C4V3RL	4	4.6	75	5	1	20	1	90
BZX55C4V7RL	4.4	5	60	5	0.5	10	1	85
BZX55C5V1RL	4.8	5.4	35	5	0.1	2	1	80
BZX55C5V6RL	5.2	6	25	5	0.1	2	1	70
BZX55C6V2RL	5.8	6.6	10	5	0.1	2	2	64
BZX55C6V8RL	6.4	7.2	8	5	0.1	2	3	58
BZX55C7V5RL	7	7.9	7	5	0.1	2	5	53
BZX55C8V2RL	7.7	8.7	7	5	0.1	2	6	47
BZX55C9V1RL	8.5	9.6	10	5	0.1	2	7	43
BZX55C10RL	9.4	10.6	15	5	0.1	2	7.5	40
BZX55C11RL	10.4	11.6	20	5	0.1	2	8.5	36
BZX55C12RL	11.4	12.7	20	5	0.1	2	9	32
BZX55C13RL	12.4	14.1	26	5	0.1	2	10	29
BZX55C15RL	13.8	15.6	30	5	0.1	2	11	27
BZX55C16RL	15.3	17.1	40	5	0.1	2	12	24
BZX55C18RL	16.8	19.1	50	5	0.1	2	14	21
BZX55C20RL	18.8	21.1	55	5	0.1	2	15	20
BZX55C22RL	20.8	23.3	55	5	0.1	2	17	18
BZX55C24RL	22.8	25.6	80	5	0.1	2	18	16
BZX55C27RL	25.1	28.9	80	5	0.1	2	20	14
BZX55C30RL	28	32	80	5	0.1	2	22	13
BZX55C33RL	31	35	80	5	0.1	2	24	12
BZX55C36RL	34	38	80	5	0.1	2	27	11
BZX55C39RL	37	41	90	2.5	0.1	5	28	10
BZX55C43RL	40	46	90	2.5	0.1	5	32	9.2
BZX55C47RL	44	50	110	2.5	0.1	5	35	8.5
BZX55C51RL	48	54	125	2.5	0.1	10	38	7.8
BZX55C56RL	52	60	135	2.5	0.1	10	42	7
BZX55C62RL	58	66	150	2.5	0.1	10	47	6.4
BZX55C68RL	64	72	160	2.5	0.1	10	51	5.9
BZX55C75RL	70	80	170	2.5	0.1	10	56	5.3
BZX55C82RL	77	87	200	2.5	0.1	10	62	4.8
BZX55C91RL	85	96	250	1	0.1	10	69	4.3

NOTE 1. TOLERANCE AND VOLTAGE DESIGNATION

Tolerance designation — The type numbers listed have zener voltage min/max limits as shown. Device tolerance of $\pm 2\%$ are indicated by a "B" instead of a "C". Zener voltage is measured with the device junction in thermal equilibrium at the lead temperature of $30^\circ\text{C} \pm 1^\circ\text{C}$ and 3/8" lead length.

NOTE 2.

This data was calculated using nominal voltages. The maximum current handling capability

on a worst case basis is limited by the actual zener voltage at the operating point and the power derating curve.

NOTE 3.

Z_{ZT} and Z_{ZK} are measured by dividing the ac voltage drop across the device by the ac current applied. The specified limits are for $I_{Z(ac)} = 0.1 I_{Z(dc)}$ with the ac frequency = 1.0 kHz.

GENERAL DATA — 500 mW DO-35 GLASS

*ELECTRICAL CHARACTERISTICS ($T_L = 30^\circ\text{C}$ unless otherwise noted.) ($V_F = 1.5$ Volts Max @ $I_F = 100$ mAdc for all types.)

Device Type (Note 2)	Zener Voltage (Note 1) (Note 4)			Impedance (Ohm) @ I_{ZT} $f = 1000$ Hz	Leakage Current (μA)		Temp. Coefficient (Typical) ($\text{mV}/^\circ\text{C}$)		Capacitance (Typical) (pF) $V_R = 0$, $f = 1.0$ MHz
	Min	Max	$I_{ZT} =$ (mA)	Max (Note 3)	Max	@ $V_R =$ (Volt)	Min	Max	
BZX79C2V4RL	2.2	2.6	5	100	100	1	-3.5	0	255
BZX79C2V7RL	2.5	2.9	5	100	75	1	-3.5	0	230
BZX79C3V0RL	2.8	3.2	5	95	50	1	-3.5	0	215
BZX79C3V3RL	3.1	3.5	5	95	25	1	-3.5	0	200
BZX79C3V6RL	3.4	3.8	5	90	15	1	-3.5	0	185
BZX79C3V9RL	3.7	4.1	5	90	10	1	-3.5	+0.3	175
BZX79C4V3RL	4	4.6	5	90	5	1	-3.5	+1	160
BZX79C4V7RL	4.4	5	5	80	3	2	-3.5	+0.2	130
BZX79C5V1RL	4.8	5.4	5	60	2	2	-2.7	+1.2	110
BZX79C5V6RL	5.2	6	5	40	1	2	-2	+2.5	95
BZX79C6V2RL	5.8	6.6	5	10	3	4	0.4	3.7	90
BZX79C6V8RL	6.4	7.2	5	15	2	4	1.2	4.5	85
BZX79C7V5RL	7	7.9	5	15	1	5	2.5	5.3	80
BZX79C8V2RL	7.7	8.7	5	15	0.7	5	3.2	6.2	75
BZX79C9V1RL	8.5	9.6	5	15	0.5	6	3.8	7	70
BZX79C10RL	9.4	10.6	5	20	0.2	7	4.5	8	70
BZX79C11RL	10.4	11.6	5	20	0.1	8	5.4	9	65
BZX79C12RL	11.4	12.7	5	25	0.1	8	6	10	65
BZX79C13RL	12.4	14.1	5	30	0.1	8	7	11	60
BZX79C15RL	13.8	15.6	5	30	0.05	10.5	9.2	13	55
BZX79C16RL	15.3	17.1	5	40	0.05	11.2	10.4	14	52
BZX79C18RL	16.8	19.1	5	45	0.05	12.6	12.9	16	47
BZX79C20RL	18.8	21.2	5	55	0.05	14	14.4	18	36
BZX79C22RL	20.8	23.3	5	55	0.05	15.4	16.4	20	34
BZX79C24RL	22.8	25.6	5	70	0.05	16.8	18.4	22	33
BZX79C27RL	25.1	28.9	2	80	0.05	18.9		23.5	30
BZX79C30RL	28	32	2	80	0.05	21		26	27
BZX79C33RL	31	35	2	80	0.05	23.1		29	25
BZX79C36RL	34	38	2	90	0.05	25.2		31	23
BZX79C39RL	37	41	2	130	0.05	27.3		34	21
BZX79C43RL	40	46	2	150	0.05	30.1		37	21
BZX79C47RL	44	50	2	170	0.05	32.9		40	19
BZX79C51RL	48	54	2	180	0.05	35.7		44	19
BZX79C56RL	52	60	2	200	0.05	39.2		47	18
BZX79C62RL	58	66	2	215	0.05	43.4		51	17
BZX79C68RL	64	72	2	240	0.05	47.6		56	17
BZX79C75RL	70	79	2	255	0.05	52.5		60	16.5
BZX79C82RL	77	87	2	280	0.1	62	46	95	29
BZX79C91RL	85	96	2	300	0.1	69	51	107	28
BZX79C100RL	94	106	1	500	0.1	76	57	119	27
BZX79C110RL	104	116	1	650	0.1	84	63	131	26
BZX79C120RL	114	127	1	800	0.1	91	69	144	24
BZX79C130RL	124	141	1	950	0.1	99	75	158	23
BZX79C150RL	138	156	1	1250	0.1	114	87	185	21
BZX79C160RL	153	171	1	1400	0.1	122	93	200	20
BZX79C180RL	168	191	1	1700	0.1	137	105	228	18
BZX79C200RL	188	212	1	2000	0.1	152	120	255	17

NOTE 1. Zener voltage is measured under pulse conditions such that T_J is no more than 2°C above T_A .

NOTE 2. TOLERANCE AND VOLTAGE DESIGNATION

Tolerance designation — The type numbers listed have zener voltage min/max limits as

shown. Device tolerances of $\pm 2\%$ are indicated by a "B" instead of a "C," and $\pm 1\%$ by "A."

NOTE 3. Z_{ZT} is measured by dividing the ac voltage drop across the device by the ac current applied. The specified limits are for $I_{Z(ac)} = 0.1 I_{Z(dc)}$ with the ac frequency = 1.0 kHz.

GENERAL DATA — 500 mW DO-35 GLASS

ELECTRICAL CHARACTERISTICS (at $T_A = 25^\circ\text{C}$)

Motorola ZPD and BZX83C series. Forward Voltage $V_F = 1$ Volt Max at $I_F = 50$ mA.

Device Type		Zener Voltage (Note 1) at $I_{ZT} = 5.0$ mA			Impedance (Ω) Max (Note 2)			Typ. Temp. Coeff. at I_{ZT} % per $^\circ\text{C}$	V_R Min		
		Nominal	Min	Max	at I_{ZT}	at $I_Z = 1$ mA			V		at I_R
						BZX83	ZPD		BZX83	ZPD	
BZX83C2V7RL	ZPD2.7RL	2.7	2.5	2.9	85	600	500	-0.09...-0.04	1	—	100 A
BZX83C3V0RL	ZPD3.0RL	3	2.8	3.2	90	600	500	-0.09...-0.03	1	—	60 A
BZX83C3V3RL	ZPD3.3RL	3.3	3.1	3.5	90	600	500	-0.08...-0.03	1	—	30 A
BZX83C3V6RL	ZPD3.6RL	3.6	3.4	3.8	90	600	500	-0.08...-0.03	1	—	20 A
BZX83C3V9RL	ZPD3.9RL	3.9	3.7	4.1	85	600	500	-0.07...-0.03	1	—	10 A
BZX83C4V3RL	ZPD4.3RL	4.3	4	4.6	80	600	500	-0.06...-0.01	1	—	5 A
BZX83C4V7RL	ZPD4.7RL	4.7	4.4	5	78	600	500	-0.05...+0.02	1	—	2 A
BZX83C5V1RL	ZPD5.1RL	5.1	4.8	5.4	60	550	480	-0.03...+0.04	0.8		100 nA
BZX83C5V6RL	ZPD5.6RL	5.6	5.2	6	40	450	400	-0.02...+0.06	1		100 nA
BZX83C6V2RL	ZPD6.2RL	6.2	5.8	6.6	10	200		-0.01...+0.07	2		100 nA
BZX83C6V8RL	ZPD6.8RL	6.8	6.4	7.2	8	150		+0.02...+0.07	3		100 nA
BZX83C7V5RL	ZPD7.5RL	7.5	7	7.9	7	50		+0.03...+0.07	5		100 nA
BZX83C8V2RL	ZPD8.2RL	8.2	7.7	8.7	7	50		+0.04...+0.07	6		100 nA
BZX83C9V1RL	ZPD9.1RL	9.1	8.5	9.6	10	50		+0.05...+0.08	7		100 nA
BZX83C10RL	ZPD10RL	10	9.4	10.6	15	70		+0.05...+0.08	7.5		100 nA
BZX83C11RL	ZPD11RL	11	10.4	11.6	20	70		+0.05...+0.09	8.5		100 nA
BZX83C12RL	ZPD12RL	12	11.4	12.7	20	90		+0.06...+0.09	9		100 nA
BZX83C13RL	ZPD13RL	13	12.4	14.1	25	110		+0.07...+0.09	10		100 nA
BZX83C15RL	ZPD15RL	15	13.8	15.6	30	110		+0.07...+0.09	11		100 nA
BZX83C16RL	ZPD16RL	16	15.3	17.1	40	170		+0.08...+0.095	12		100 nA
BZX83C18RL	ZPD18RL	18	16.8	19.1	50	170		+0.08...+0.10	14		100 nA
BZX83C20RL	ZPD20RL	20	18.8	21.2	55	220		+0.08...+0.10	15		100 nA
BZX83C22RL	ZPD22RL	22	20.8	23.3	55	220		+0.08...+0.10	17		100 nA
BZX83C24RL	ZPD24RL	24	22.8	25.6	80	220		+0.08...+0.10	18		100 nA
BZX83C27RL	ZPD27RL	27	25.1	28.9	80	250		+0.08...+0.10	20		100 nA
BZX83C30RL	ZPD30RL	30	28	32	80	250		+0.08...+0.10	22		100 nA
BZX83C33RL	ZPD33RL	33	31	35	80	250		+0.08...+0.10	24		100 nA

NOTE 1. Pulse test.

NOTE 2. $f = 1.0$ kHz, $I_Z(\text{ac}) = 0.1 I_Z(\text{dc})$.

GENERAL DATA — 500 mW DO-35 GLASS

Designed for 250 mW applications requiring low leakage, low impedance. Same as 1N4099 through 1N4104 and 1N4614 through 1N4627 except low noise test omitted.

- Voltage Range from 1.8 to 10 Volts
- Zener Impedance and Zener Voltage Specified for Low-Level Operation at $I_{ZT} = 250 \mu\text{A}$

ELECTRICAL CHARACTERISTICS ($T_A = 25^\circ\text{C}$ unless otherwise specified. $I_{ZT} = 250 \mu\text{A}$ and $V_F = 1 \text{ V Max}$ @ $I_F = 200 \text{ mA}$ for all types)

Type Number (Note 1)	Nominal Zener Voltage V_Z (Note 2) (Volts)	Max Zener Impedance Z_{ZT} (Note 3) (Ohms)	Max Reverse Current I_R (μA)	@ (Note 5)	Test Voltage V_R (Volts)	Max Zener Current I_{ZM} (Note 4) (mA)
MZ4614	1.8	1200	7.5		1	120
MZ4615	2	1250	5		1	110
MZ4616	2.2	1300	4		1	100
MZ4617	2.4	1400	2		1	95
MZ4618	2.7	1500	1		1	90
MZ4619	3	1600	0.8		1	85
MZ4620	3.3	1650	7.5		1.5	80
MZ4621	3.6	1700	7.5		2	75
MZ4622	3.9	1650	5		2	70
MZ4623	4.3	1600	4		2	65
MZ4624	4.7	1550	10		3	60
MZ4625	5.1	1500	10		3	55
MZ4626	5.6	1400	10		4	50
MZ4627	6.2	1200	10		5	45
MZ4099	6.8	200	10		5.2	35
MZ4100	7.5	200	10		5.7	31.8
MZ4101	8.2	200	1		6.3	29
MZ4102	8.7	200	1		6.7	27.4
MZ4103	9.1	200	1		7	26.2
MZ4104	10	200	1		7.6	24.8

NOTE 1. TOLERANCE AND VOLTAGE DESIGNATION

The type numbers shown have a standard tolerance of $\pm 5\%$ on the nominal zener voltage.

NOTE 2. ZENER VOLTAGE (V_Z) MEASUREMENT

Nominal Zener Voltage is measured with the device junction in the thermal equilibrium with ambient temperature of 25°C .

NOTE 3. ZENER IMPEDANCE (Z_{ZT}) DERIVATION

The zener impedance is derived from the 60 cycle ac voltage, which results when an ac current having an rms value equal to 10% of the dc zener current (I_{ZT}) is superimposed on I_{ZT} .

NOTE 4. MAXIMUM ZENER CURRENT RATINGS (I_{ZM})

Maximum zener current ratings are based on maximum zener voltage of the individual units.

NOTE 5. REVERSE LEAKAGE CURRENT I_R

Reverse leakage currents are guaranteed and are measured at V_R as shown on the table.

NOTE 6. SPECIAL SELECTORS AVAILABLE INCLUDE:

A) Tighter voltage tolerances. Contact your nearest Motorola representative for more information.

GENERAL DATA — 500 mW DO-35 GLASS

Low Voltage Avalanche Passivated Silicon Oxide Zener Regulator Diodes

Same as 1N5520B through 1N5530B except low noise test spec omitted.

- Low Maximum Regulation Factor
- Low Zener Impedance
- Low Leakage Current

ELECTRICAL CHARACTERISTICS ($T_A = 25^\circ\text{C}$ unless otherwise specified. Based on dc measurements at thermal equilibrium; $V_F = 1.1$ Max @ $I_F = 200$ mA for all types.)

Motorola Type No. (Note 1)	Nominal Zener Voltage V_Z @ I_{ZT} Volts (Note 2)	Test Current I_{ZT} mAdc	Max Zener Impedance Z_{ZT} @ I_{ZT} Ohms (Note 3)	Max Reverse Leakage Current		Maximum DC Zener Current I_{ZM} mAdc (Note 5)	Regulation Factor ΔV_Z Volts (Note 6)	Low V_Z Current I_{ZL} mAdc
				I_R μAdc (Note 4)	V_R - Volts			
MZ5520B	3.9	20	22	1	1	98	0.85	2.0
MZ5521B	4.3	20	18	3	1.5	88	0.75	2.0
MZ5522B	4.7	10	22	2	2	81	0.6	1.0
MZ5523B	5.1	5	26	2	2.5	75	0.65	0.25
MZ5524B	5.6	3	30	2	3.5	68	0.3	0.25
MZ5525B	6.2	1	30	1	5	61	0.2	0.01
MZ5526B	6.8	1	30	1	6.2	56	0.1	0.01
MZ5527B	7.5	1	35	0.5	6.8	51	0.05	0.01
MZ5528B	8.2	1	40	0.5	7.5	46	0.05	0.01
MZ5529B	9.1	1	45	0.1	8.2	42	0.05	0.01
MZ5530B	10	1	60	0.05	9.1	38	0.1	0.01

NOTE 1. TOLERANCE AND VOLTAGE DESIGNATION

The "B" suffix type numbers listed are $\pm 5\%$ tolerance of nominal V_Z .

NOTE 2. ZENER VOLTAGE (V_Z) MEASUREMENT

Nominal zener voltage is measured with the device junction in thermal equilibrium with ambient temperature of 25°C .

NOTE 3. ZENER IMPEDANCE (Z_Z) DERIVATION

The zener impedance is derived from the 60 Hz ac voltage, which results when an ac current having an rms value equal to 10% of the dc zener current (I_{ZT}) is superimposed on I_{ZT} .

NOTE 4. REVERSE LEAKAGE CURRENT I_R

Reverse leakage currents are guaranteed and are measured at V_R as shown on the table.

NOTE 5. MAXIMUM REGULATOR CURRENT (I_{ZM})

The maximum current shown is based on the maximum voltage of a $\pm 5\%$ type unit, therefore, it applies only to the "B" suffix device. The actual I_{ZM} for any device may not exceed the value of 400 milliwatts divided by the actual V_Z of the device.

NOTE 6. MAXIMUM REGULATION FACTOR (ΔV_Z)

ΔV_Z is the maximum difference between V_Z at I_{ZT} and V_Z at I_{ZL} measured with the device junction in thermal equilibrium.

NOTE 7. SPECIAL SELECTORS AVAILABLE INCLUDE:

A) Tighter voltage tolerances. Contact your nearest Motorola representative for more information.

GENERAL DATA — 500 mW DO-35 GLASS

Zener Voltage Regulator Diodes — Axial Leaded

500 mW DO-35 Glass

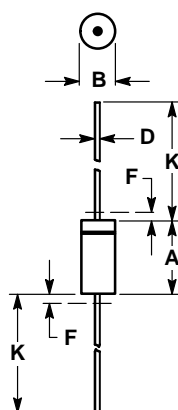

NOTES:

1. PACKAGE CONTOUR OPTIONAL WITHIN A AND B HEAT SLUGS, IF ANY, SHALL BE INCLUDED WITHIN THIS CYLINDER, BUT NOT SUBJECT TO THE MINIMUM LIMIT OF B.
2. LEAD DIAMETER NOT CONTROLLED IN ZONE F TO ALLOW FOR FLASH, LEAD FINISH BUILDUP AND MINOR IRREGULARITIES OTHER THAN HEAT SLUGS.
3. POLARITY DENOTED BY CATHODE BAND.
4. DIMENSIONING AND TOLERANCING PER ANSI Y14.5M, 1982.

DIM	MILLIMETERS		INCHES	
	MIN	MAX	MIN	MAX
A	3.05	5.08	0.120	0.200
B	1.52	2.29	0.060	0.090
D	0.46	0.56	0.018	0.022
F	—	1.27	—	0.050
K	25.40	38.10	1.000	1.500

All JEDEC dimensions and notes apply.

CASE 299-02
DO-204AH
GLASS

(Refer to Section 10 for Surface Mount, Thermal Data and Footprint Information.)

MULTIPLE PACKAGE QUANTITY (MPQ) REQUIREMENTS

Package Option	Type No. Suffix	MPQ (Units)
Tape and Reel	RL, RL2(1)	5K
Tape and Ammo	TA, TA2(1)	5K

NOTES: 1. The "2" suffix refers to 26 mm tape spacing.
2. Radial Tape and Reel may be available. Please contact your Motorola representative.

Refer to Section 10 for more information on Packaging Specifications.

GENERAL DATA — 500 mW DO-35 GLASS

1–1.3 Watt DO-41 Glass Zener Voltage Regulator Diodes GENERAL DATA APPLICABLE TO ALL SERIES IN THIS GROUP

One Watt Hermetically Sealed Glass Silicon Zener Diodes

Specification Features:

- Complete Voltage Range — 3.3 to 100 Volts
- DO-41 Package
- Double Slug Type Construction
- Metallurgically Bonded Construction
- Oxide Passivated Die

Mechanical Characteristics:

CASE: Double slug type, hermetically sealed glass

MAXIMUM LEAD TEMPERATURE FOR SOLDERING PURPOSES: 230°C, 1/16" from case for 10 seconds

FINISH: All external surfaces are corrosion resistant with readily solderable leads

POLARITY: Cathode indicated by color band. When operated in zener mode, cathode will be positive with respect to anode

MOUNTING POSITION: Any

WAFER FAB LOCATION: Phoenix, Arizona

ASSEMBLY/TEST LOCATION: Seoul, Korea

**GENERAL
DATA
1–1.3 WATT
DO-41 GLASS**

**1 WATT
ZENER REGULATOR
DIODES
3.3–100 VOLTS**

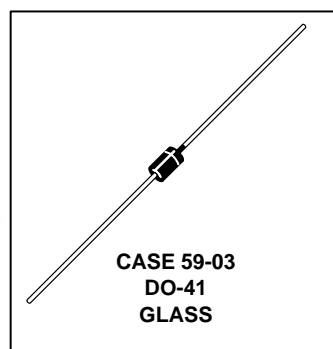

MAXIMUM RATINGS

Rating	Symbol	Value	Unit
DC Power Dissipation @ $T_A = 50^\circ\text{C}$ Derate above 50°C	P_D	1 6.67	Watt mW/ $^\circ\text{C}$
Operating and Storage Junction Temperature Range	T_J, T_{stg}	-65 to +200	$^\circ\text{C}$

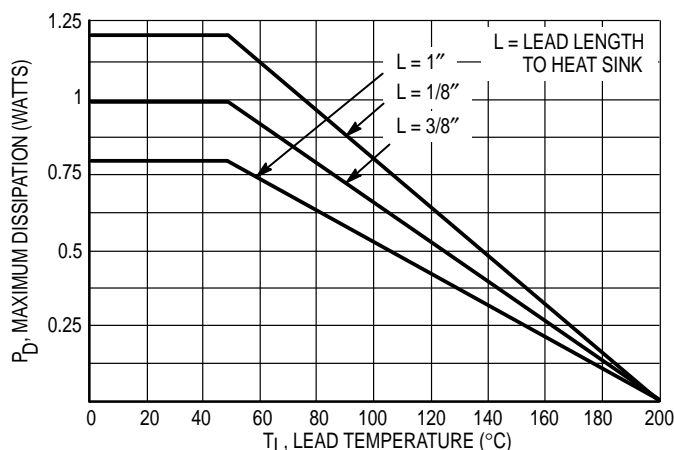

GENERAL DATA — 500 mW DO-35 GLASS

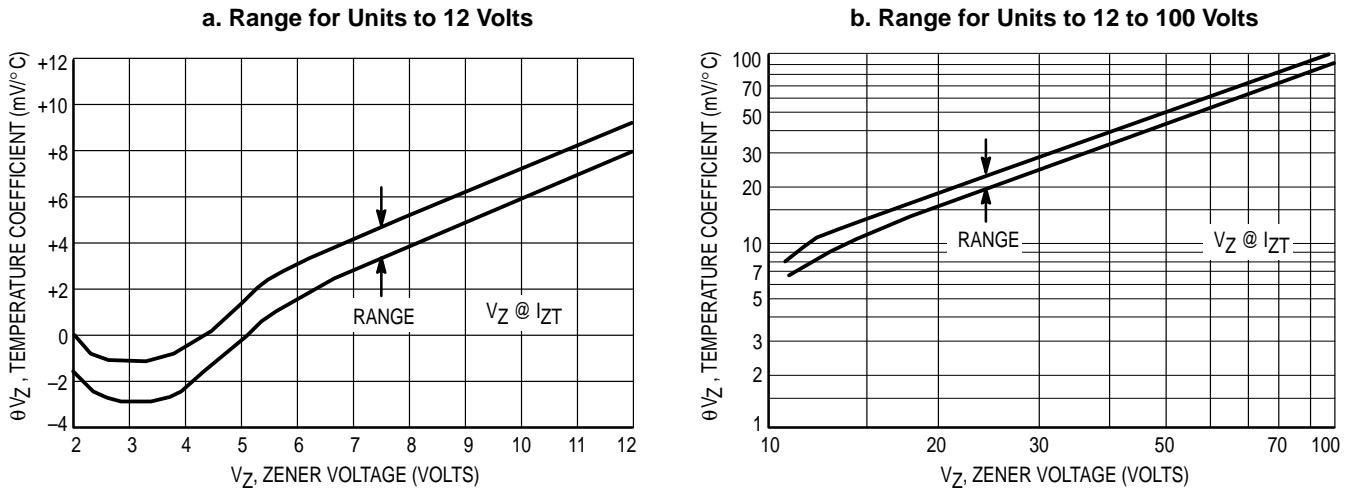

Figure 2. Temperature Coefficients
 (-55°C to +150°C temperature range; 90% of the units are in the ranges indicated.)

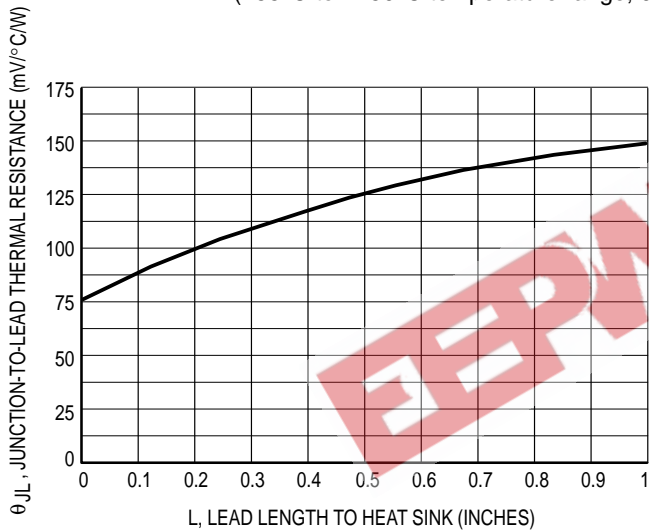

Figure 3. Typical Thermal Resistance versus Lead Length

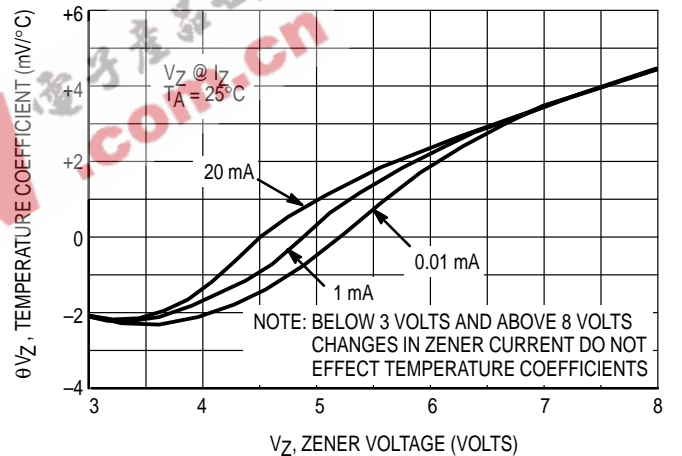

Figure 4. Effect of Zener Current

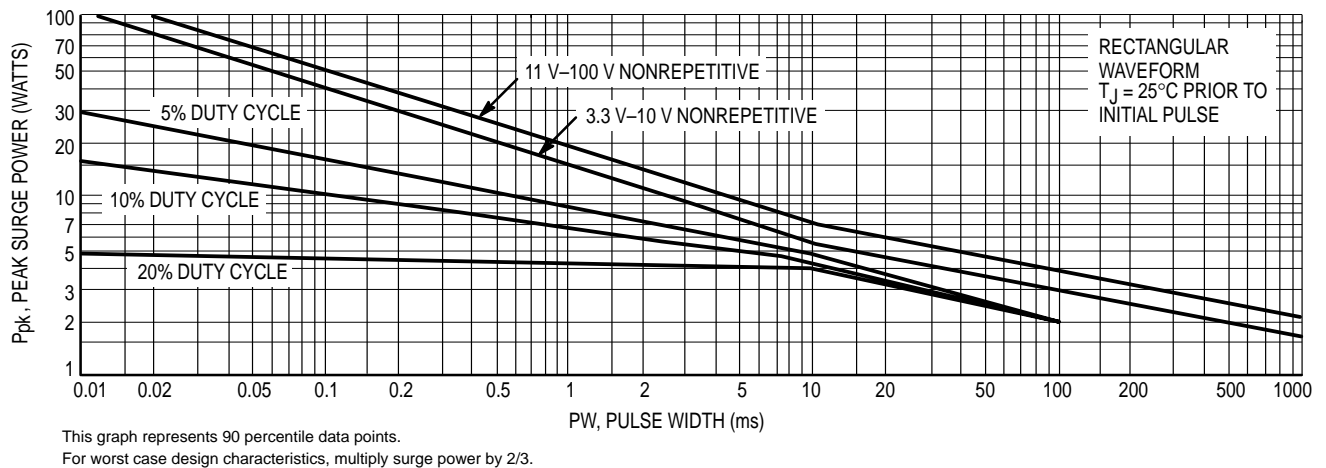

Figure 5. Maximum Surge Power

GENERAL DATA — 500 mW DO-35 GLASS

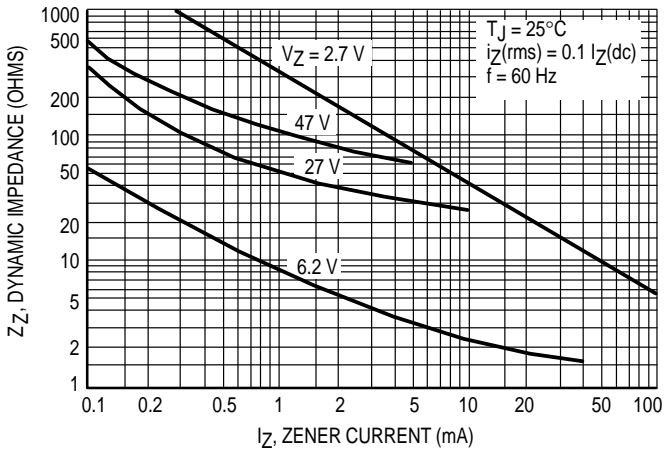

Figure 6. Effect of Zener Current on Zener Impedance

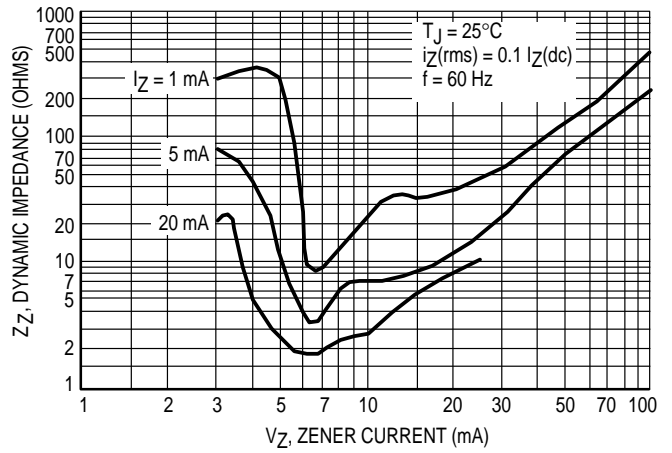

Figure 7. Effect of Zener Voltage on Zener Impedance

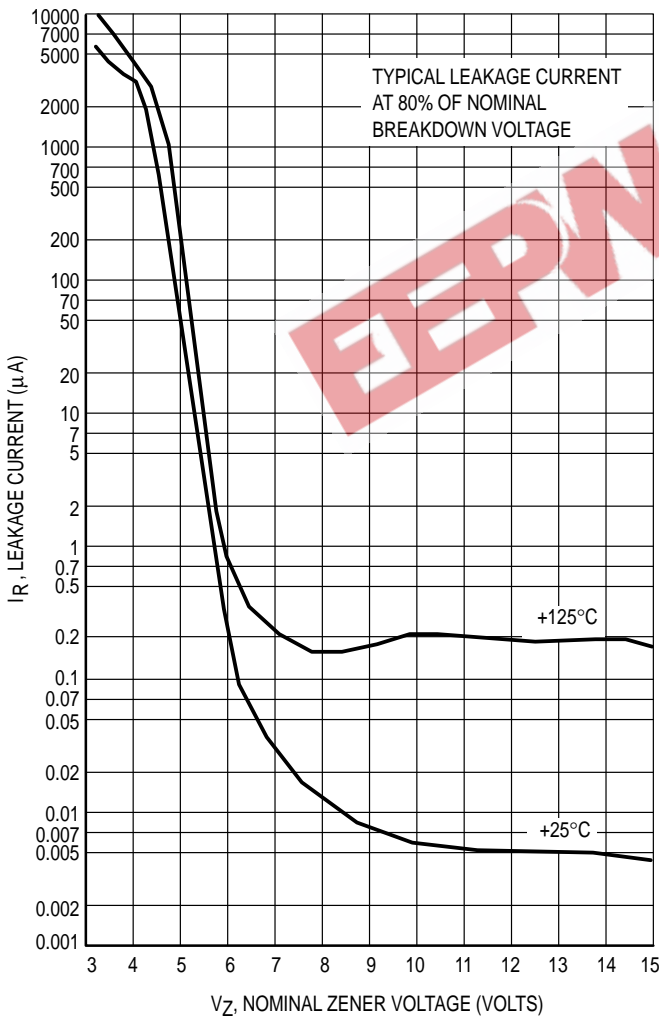

Figure 8. Typical Leakage Current

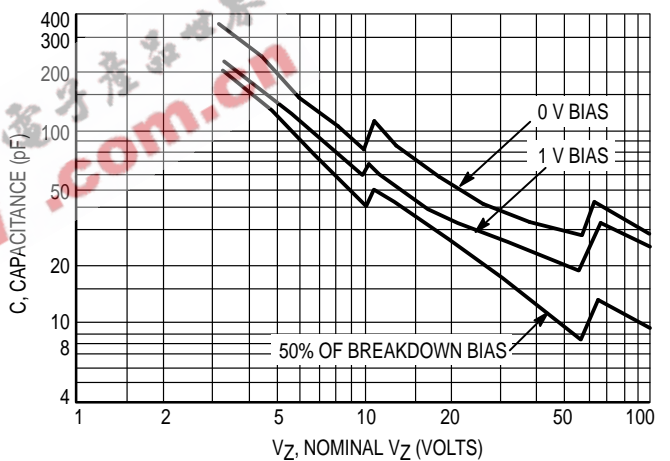

Figure 9. Typical Capacitance versus V_Z

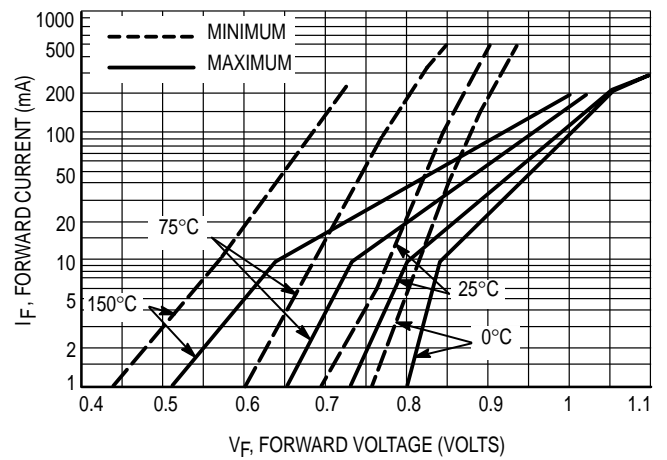

Figure 10. Typical Forward Characteristics

GENERAL DATA — 500 mW DO-35 GLASS

APPLICATION NOTE

Since the actual voltage available from a given zener diode is temperature dependent, it is necessary to determine junction temperature under any set of operating conditions in order to calculate its value. The following procedure is recommended:

Lead Temperature, T_L , should be determined from:

$$T_L = \theta_{LA} P_D + T_A.$$

θ_{LA} is the lead-to-ambient thermal resistance ($^{\circ}\text{C}/\text{W}$) and P_D is the power dissipation. The value for θ_{LA} will vary and depends on the device mounting method. θ_{LA} is generally 30 to $40^{\circ}\text{C}/\text{W}$ for the various clips and tie points in common use and for printed circuit board wiring.

The temperature of the lead can also be measured using a thermocouple placed on the lead as close as possible to the tie point. The thermal mass connected to the tie point is normally large enough so that it will not significantly respond to heat surges generated in the diode as a result of pulsed operation once steady-state conditions are achieved. Using the measured value of T_L , the junction temperature may be determined by:

$$T_J = T_L + \Delta T_{JL}.$$

ΔT_{JL} is the increase in junction temperature above the lead

temperature and may be found as follows:

$$\Delta T_{JL} = \theta_{JL} P_D.$$

θ_{JL} may be determined from Figure 3 for dc power conditions. For worst-case design, using expected limits of I_Z , limits of P_D and the extremes of T_J (ΔT_J) may be estimated. Changes in voltage, V_Z , can then be found from:

$$\Delta V = \theta_{VZ} \Delta T_J.$$

θ_{VZ} , the zener voltage temperature coefficient, is found from Figure 2.

Under high power-pulse operation, the zener voltage will vary with time and may also be affected significantly by the zener resistance. For best regulation, keep current excursions as low as possible.

Surge limitations are given in Figure 5. They are lower than would be expected by considering only junction temperature, as current crowding effects cause temperatures to be extremely high in small spots, resulting in device degradation should the limits of Figure 5 be exceeded.

EEPW.com.cn 电子产品世界

GENERAL DATA — 500 mW DO-35 GLASS

*ELECTRICAL CHARACTERISTICS ($T_A = 25^\circ\text{C}$ unless otherwise noted) $V_F = 1.2\text{ V Max}$, $I_F = 200\text{ mA}$ for all types.

JEDEC Type No. (Note 1)	Nominal Zener Voltage V_Z @ I_{ZT} Volts (Notes 2 and 3)	Test Current I_{ZT} mA	Maximum Zener Impedance (Note 4)			Leakage Current		Surge Current @ $T_A = 25^\circ\text{C}$ i_r - mA (Note 5)
			Z_{ZT} @ I_{ZT} Ohms	Z_{ZK} @ I_{ZK} Ohms	I_{ZK} mA	I_R $\mu\text{A Max}$	V_R Volts	
1N4728A	3.3	76	10	400	1	100	1	1380
1N4729A	3.6	69	10	400	1	100	1	1260
1N4730A	3.9	64	9	400	1	50	1	1190
1N4731A	4.3	58	9	400	1	10	1	1070
1N4732A	4.7	53	8	500	1	10	1	970
1N4733A	5.1	49	7	550	1	10	1	890
1N4734A	5.6	45	5	600	1	10	2	810
1N4735A	6.2	41	2	700	1	10	3	730
1N4736A	6.8	37	3.5	700	1	10	4	660
1N4737A	7.5	34	4	700	0.5	10	5	605
1N4738A	8.2	31	4.5	700	0.5	10	6	550
1N4739A	9.1	28	5	700	0.5	10	7	500
1N4740A	10	25	7	700	0.25	10	7.6	454
1N4741A	11	23	8	700	0.25	5	8.4	414
1N4742A	12	21	9	700	0.25	5	9.1	380
1N4743A	13	19	10	700	0.25	5	9.9	344
1N4744A	15	17	14	700	0.25	5	11.4	304
1N4745A	16	15.5	16	700	0.25	5	12.2	285
1N4746A	18	14	20	750	0.25	5	13.7	250
1N4747A	20	12.5	22	750	0.25	5	15.2	225
1N4748A	22	11.5	23	750	0.25	5	16.7	205
1N4749A	24	10.5	25	750	0.25	5	18.2	190
1N4750A	27	9.5	35	750	0.25	5	20.6	170
1N4751A	30	8.5	40	1000	0.25	5	22.8	150
1N4752A	33	7.5	45	1000	0.25	5	25.1	135
1N4753A	36	7	50	1000	0.25	5	27.4	125
1N4754A	39	6.5	60	1000	0.25	5	29.7	115
1N4755A	43	6	70	1500	0.25	5	32.7	110
1N4756A	47	5.5	80	1500	0.25	5	35.8	95
1N4757A	51	5	95	1500	0.25	5	38.8	90
1N4758A	56	4.5	110	2000	0.25	5	42.6	80
1N4759A	62	4	125	2000	0.25	5	47.1	70
1N4760A	68	3.7	150	2000	0.25	5	51.7	65
1N4761A	75	3.3	175	2000	0.25	5	56	60
1N4762A	82	3	200	3000	0.25	5	62.2	55
1N4763A	91	2.8	250	3000	0.25	5	69.2	50
1N4764A	100	2.5	350	3000	0.25	5	76	45

*Indicates JEDEC Registered Data.

NOTE 1. TOLERANCE AND TYPE NUMBER DESIGNATION

The JEDEC type numbers listed have a standard tolerance on the nominal zener voltage of $\pm 5\%$. C for $\pm 2\%$, D for $\pm 1\%$.

NOTE 2. SPECIALS AVAILABLE INCLUDE:

Nominal zener voltages between the voltages shown and tighter voltage tolerances.

For detailed information on price, availability, and delivery, contact your nearest Motorola representative.

NOTE 3. ZENER VOLTAGE (V_Z) MEASUREMENT

Motorola guarantees the zener voltage when measured at 90 seconds while maintaining the lead temperature (T_L) at $30^\circ\text{C} \pm 1^\circ\text{C}$, $3/8''$ from the diode body.

NOTE 4. ZENER IMPEDANCE (Z_Z) DERIVATION

The zener impedance is derived from the 60 cycle ac voltage, which results when an ac current having an rms value equal to 10% of the dc zener current (I_{ZT} or I_{ZK}) is superimposed on I_{ZT} or I_{ZK} .

NOTE 5. SURGE CURRENT (i_r) NON-REPETITIVE

The rating listed in the electrical characteristics table is maximum peak, non-repetitive, reverse surge current of 1/2 square wave or equivalent sine wave pulse of 1/120 second duration superimposed on the test current, I_{ZT} , per JEDEC registration; however, actual device capability is as described in Figure 5 of the General Data — DO-41 Glass.

GENERAL DATA — 500 mW DO-35 GLASS

ELECTRICAL CHARACTERISTICS ($T_A = 25^\circ\text{C}$ unless otherwise noted.) ($V_F = 1.2\text{ V Max}$, $I_F = 200\text{ mA}$ for all types.)

Type (Note 1)	Zener Voltage V_{ZT} (V) (Notes 2 and 3)		Test Current I_{ZT} (mA)	Zener Impedance Z_Z (ohms) (Note 4)			Leakage Current (μA)		Surge Current i_r (mA) (Note 5)
	V_Z Min	V_Z Max		Max at I_{ZT}	Max at I_Z (mA)		V_R (V)	I_R Max	
BZX85C3V3RL	3.1	3.5	80	20	400	1	1	60	1380
BZX85C3V6RL	3.4	3.8	60	15	500	1	1	30	1260
BZX85C3V9RL	3.7	4.1	60	15	500	1	1	5	1190
BZX85C4V3RL	4	4.6	50	13	500	1	1	3	1070
BZX85C4V7RL	4.4	5	45	13	600	1	1.5	3	970
BZX85C5V1RL	4.8	5.4	45	10	500	1	2	1	890
BZX85C5V6RL	5.2	6	45	7	400	1	2	1	810
BZX85C6V2RL	5.8	6.6	35	4	300	1	3	1	730
BZX85C6V8RL	6.4	7.2	35	3.5	300	1	4	1	660
BZX85C7V5RL	7	7.9	35	3	200	0.5	4.5	1	605
BZX85C8V2RL	7.7	8.7	25	5	200	0.5	5	1	550
BZX85C9V1RL	8.5	9.6	25	5	200	0.5	6.5	1	500
BZX85C10RL	9.4	10.6	25	7	200	0.5	7	0.5	454
BZX85C11RL	10.4	11.6	20	8	300	0.5	7.7	0.5	414
BZX85C12RL	11.4	12.7	20	9	350	0.5	8.4	0.5	380
BZX85C13RL	12.4	14.1	20	10	400	0.5	9.1	0.5	344
BZX85C15RL	13.8	15.6	15	15	500	0.5	10.5	0.5	304
BZX85C16RL	15.3	17.1	15	15	500	0.5	11	0.5	285
BZX85C18RL	16.8	19.1	15	20	500	0.5	12.5	0.5	250
BZX85C20RL	18.8	21.2	10	24	600	0.5	14	0.5	225
BZX85C22RL	20.8	23.3	10	25	600	0.5	15.5	0.5	205
BZX85C24RL	22.8	25.6	10	25	600	0.5	17	0.5	190
BZX85C27RL	25.1	28.9	8	30	750	0.25	19	0.5	170
BZX85C30RL	28	32	8	30	1000	0.25	21	0.5	150
BZX85C33RL	31	35	8	35	1000	0.25	23	0.5	135
BZX85C36RL	34	38	8	40	1000	0.25	25	0.5	125
BZX85C39RL	37	41	6	45	1000	0.25	27	0.5	115
BZX85C43RL	40	46	6	50	1000	0.25	30	0.5	110
BZX85C47RL	44	50	4	90	1500	0.25	33	0.5	95
BZX85C51RL	48	54	4	115	1500	0.25	36	0.5	90
BZX85C56RL	52	60	4	120	2000	0.25	39	0.5	80
BZX85C62RL	58	66	4	125	2000	0.25	43	0.5	70
BZX85C68RL	64	72	4	130	2000	0.25	47	0.5	65
BZX85C75RL	70	80	4	150	2000	0.25	51	0.5	60
BZX85C82RL	77	87	2.7	200	3000	0.25	56	0.5	55
BZX85C91RL	85	96	2.7	250	3000	0.25	62	0.5	50
BZX85C100RL	96	106	2.7	350	3000	0.25	68	0.5	45

NOTE 1. TOLERANCE AND TYPE NUMBER DESIGNATION

The type numbers listed have zener voltage min/max limits as shown. Device tolerance of $\pm 2\%$ are indicated by a "B" instead of "C."

NOTE 2. SPECIALS AVAILABLE INCLUDE:

Nominal zener voltages between the voltages shown and tighter voltage tolerances.
For detailed information on price, availability, and delivery, contact your nearest Motorola representative.

NOTE 3. ZENER VOLTAGE (V_Z) MEASUREMENT

V_Z is measured after the test current has been applied to 40 ± 10 msec., while maintaining the lead temperature (T_L) at $30^\circ\text{C} \pm 1^\circ\text{C}$, $3/8"$ from the diode body.

NOTE 4. ZENER IMPEDANCE (Z_Z) DERIVATION

The zener impedance is derived from the 1 kHz cycle ac voltage, which results when an ac current having an rms value equal to 10% of the dc zener current (I_{ZT}) or (I_{ZK}) is superimposed on I_{ZT} or I_{ZK} .

NOTE 5. SURGE CURRENT (i_r) NON-REPETITIVE

The rating listed in the electrical characteristics table is maximum peak, non-repetitive, reverse surge current of 1/2 square wave or equivalent sine wave pulse of 1/120 second duration superimposed on the test current I_{ZT} . However, actual device capability is as described in Figure 5 of General Data DO-41 glass.

GENERAL DATA — 500 mW DO-35 GLASS

ELECTRICAL CHARACTERISTICS ($T_A = 25^\circ\text{C}$ unless otherwise noted) $V_F = 1.2\text{ V Max}$, $I_F = 200\text{ mA}$ for all types.

Type No. (Note 1)	Zener Voltage (V) (Notes 2 and 3)		Test Current I_{ZT} (mA)	Zener Impedance (Note 4) $f = 1\text{ kHz (ohms)}$		Blocking Volt Min (V) $I_R = 1\ \mu\text{A}$	Surge Current $T_A = 25^\circ\text{C}$ i_r (mA) (Note 5)
	V_Z Min	V_Z Max		Typ	Max		
MZPY3.9RL	3.7	4.1	100	4	7	—	1190
MZPY4.3RL	4	4.6	100	4	7	—	1070
MZPY4.7RL	4.4	5	100	4	7	—	970
MZPY5.1RL	4.8	5.4	100	2	5	0.7	890
MZPY5.6RL	5.2	6	100	1	2	1.5	810
MZPY6.2RL	5.8	6.6	100	1	2	2	730
MZPY6.8RL	6.4	7.2	100	1	2	3	660
MZPY7.5RL	7	7.9	100	1	2	5	605
MZPY8.2RL	7.7	8.7	100	1	2	6	550
MZPY9.1RL	8.5	9.6	50	2	4	7	500
MZPY10RL	9.4	10.6	50	2	4	7.5	454
MZPY11RL	10.4	11.6	50	3	7	8.5	414
MZPY12RL	11.4	12.7	50	3	7	9	380
MZPY13RL	12.4	14.1	50	4	9	10	344
MZPY15RL	14.2	15.8	50	4	9	11	304
MZPY16RL	15.3	17.1	25	5	10	12	285
MZPY18RL	16.8	19.1	25	5	11	14	250
MZPY20RL	18.8	21.2	25	6	12	15	225
MZPY22RL	20.8	23.3	25	7	13	17	205
MZPY24RL	22.8	25.6	25	8	14	18	190
MZPY27RL	25.1	28.9	25	9	15	20	170
MZPY30RL	28	32	25	10	20	22.5	150
MZPY33RL	31	35	25	11	20	25	135
MZPY36RL	34	38	10	25	60	27	125
MZPY39RL	37	41	10	30	60	29	115
MZPY43RL	40	46	10	35	80	32	110
MZPY47RL	44	50	10	40	80	35	95
MZPY51RL	48	54	10	45	100	38	90
MZPY56RL	52	60	10	50	100	42	80
MZPY62RL	58	66	10	60	130	47	70
MZPY68RL	64	72	10	65	130	51	65
MZPY75RL	70	79	10	70	160	56	60
MZPY82RL	77	88	10	80	160	61	55
MZPY91RL	85	96	5	120	250	68	50
MZPY100RL	94	106	5	130	250	75	45

NOTE 1. TOLERANCE AND TYPE NUMBER DESIGNATION

The type numbers listed have zener voltage min/max limits as shown. Device tolerance of $\pm 2\%$ are indicated by a "C" and $\pm 1\%$ by a "D" suffix.

NOTE 2. SPECIALS AVAILABLE INCLUDE:

Nominal zener voltages between the voltages shown and tighter voltage tolerances.

For detailed information on price, availability, and delivery, contact your nearest Motorola representative.

NOTE 3. ZENER VOLTAGE (V_Z) MEASUREMENT

V_Z is measured after the test current has been applied to 40 ± 10 msec., while maintaining the lead temperature (T_L) at $30^\circ\text{C} \pm 1^\circ\text{C}$, $3/8"$ from the diode body.

NOTE 4. ZENER IMPEDANCE (Z_Z) DERIVATION

The zener impedance is derived from the 1 kHz cycle ac voltage, which results when an ac current having an rms value equal to 10% of the dc zener current (I_{ZT}) or (I_{ZK}) is superimposed on I_{ZT} or I_{ZK} .

NOTE 5. SURGE CURRENT (i_r) NON-REPETITIVE

The rating listed in the electrical characteristics table is maximum peak, non-repetitive, reverse surge current of 1/2 square wave or equivalent sine wave pulse of 1/120 second duration superimposed on the test current I_{ZT} , however, actual device capability is as described in Figure 5 of General Data DO-41 glass.

GENERAL DATA — 500 mW DO-35 GLASS

Zener Voltage Regulator Diodes — Axial Leaded

1–1.3 Watt DO-41 Glass

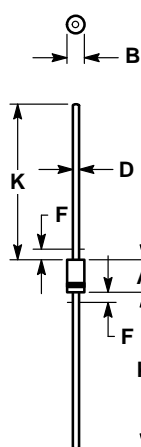

- NOTES:
1. ALL RULES AND NOTES ASSOCIATED WITH JEDEC DO-41 OUTLINE SHALL APPLY.
 2. POLARITY DENOTED BY CATHODE BAND.
 3. LEAD DIAMETER NOT CONTROLLED WITHIN F DIMENSION.

DIM	MILLIMETERS		INCHES	
	MIN	MAX	MIN	MAX
A	4.07	5.20	0.160	0.205
B	2.04	2.71	0.080	0.107
D	0.71	0.86	0.028	0.034
F	—	1.27	—	0.050
K	27.94	—	1.100	—

CASE 59-03
DO-41
GLASS

(Refer to Section 10 for Surface Mount, Thermal Data and Footprint Information.)

MULTIPLE PACKAGE QUANTITY (MPQ) REQUIREMENTS

Package Option	Type No. Suffix	MPQ (Units)
Tape and Reel	RL, RL2	6K
Tape and Ammo	TA, TA2	4K

NOTE: 1. The "2" suffix refers to 26 mm tape spacing.

(Refer to Section 10 for more information on Packaging Specifications.)

GENERAL DATA — 500 mW DO-35 GLASS

1 to 3 Watt DO-41 Surmetic 30 Zener Voltage Regulator Diodes GENERAL DATA APPLICABLE TO ALL SERIES IN THIS GROUP

1 to 3 Watt Surmetic 30 Silicon Zener Diodes

... a complete series of 1 to 3 Watt Zener Diodes with limits and operating characteristics that reflect the superior capabilities of silicon-oxide-passivated junctions. All this in an axial-lead, transfer-molded plastic package offering protection in all common environmental conditions.

Specification Features:

- Surge Rating of 98 Watts @ 1 ms
- Maximum Limits Guaranteed On Up To Six Electrical Parameters
- Package No Larger Than the Conventional 1 Watt Package

Mechanical Characteristics:

CASE: Void-free, transfer-molded, thermosetting plastic

FINISH: All external surfaces are corrosion resistant and leads are readily solderable

POLARITY: Cathode indicated by color band. When operated in zener mode, cathode will be positive with respect to anode

MOUNTING POSITION: Any

WEIGHT: 0.4 gram (approx)

WAFER FAB LOCATION: Phoenix, Arizona

ASSEMBLY/TEST LOCATION: Seoul, Korea

GENERAL DATA 1-3 WATT DO-41 SURMETIC 30

1 TO 3 WATT ZENER REGULATOR DIODES 3.3-400 VOLTS

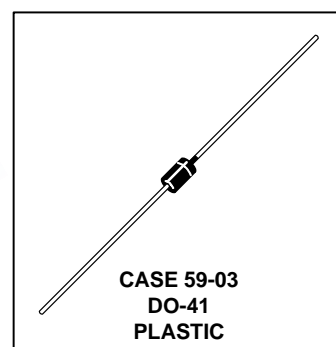

MAXIMUM RATINGS

Rating	Symbol	Value	Unit
DC Power Dissipation @ $T_L = 75^\circ\text{C}$ Lead Length = 3/8" Derate above 75°C	P_D	3	Watts
		24	mW/°C
DC Power Dissipation @ $T_A = 50^\circ\text{C}$ Derate above 50°C	P_D	1	Watt
		6.67	mW/°C
Operating and Storage Junction Temperature Range	T_J, T_{stg}	- 65 to +200	°C

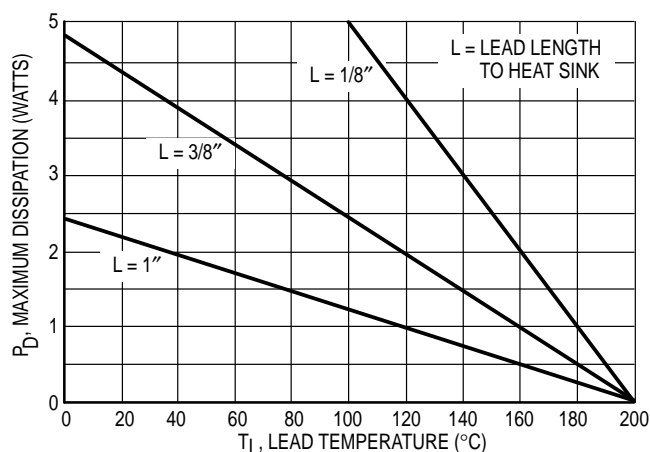

Figure 1. Power Temperature Derating Curve

GENERAL DATA — 500 mW DO-35 GLASS

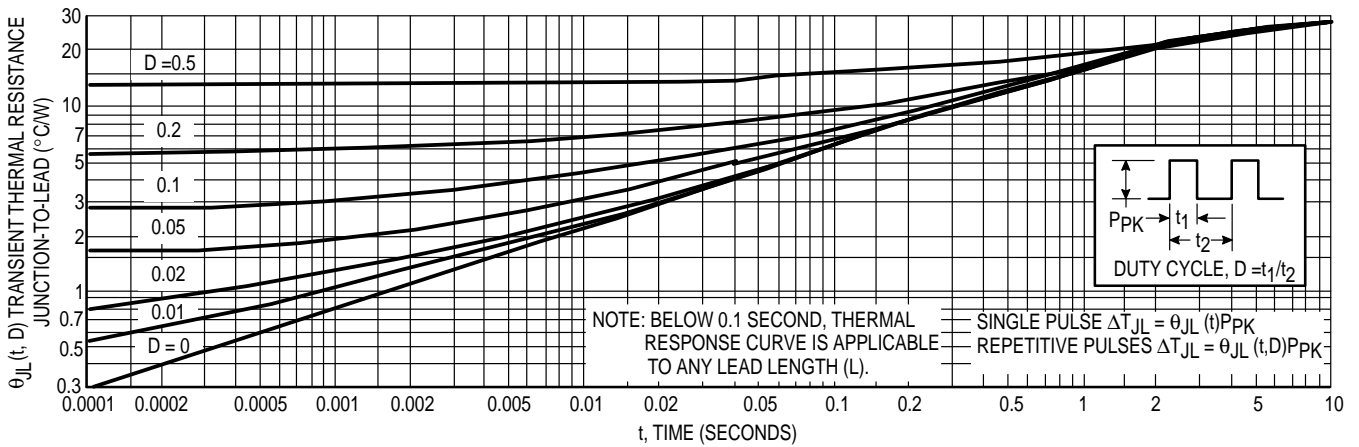

Figure 2. Typical Thermal Response L, Lead Length = 3/8 Inch

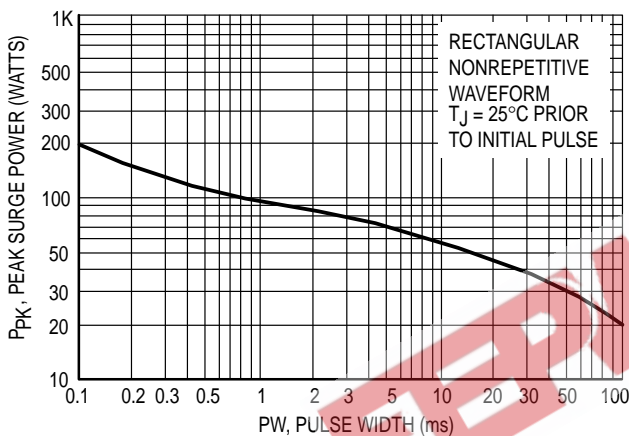

Figure 3. Maximum Surge Power

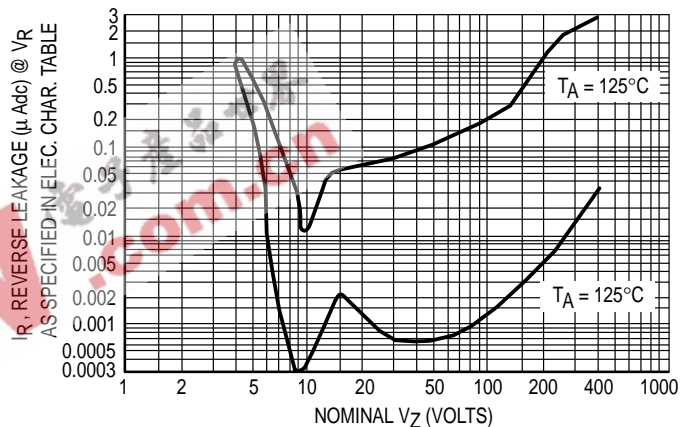

Figure 4. Typical Reverse Leakage

APPLICATION NOTE

Since the actual voltage available from a given zener diode is temperature dependent, it is necessary to determine junction temperature under any set of operating conditions in order to calculate its value. The following procedure is recommended:

Lead Temperature, T_L , should be determined from:

$$T_L = \theta_{LA} P_D + T_A$$

θ_{LA} is the lead-to-ambient thermal resistance ($^{\circ}\text{C}/\text{W}$) and P_D is the power dissipation. The value for θ_{LA} will vary and depends on the device mounting method. θ_{LA} is generally $30\text{--}40^{\circ}\text{C}/\text{W}$ for the various clips and tie points in common use and for printed circuit board wiring.

The temperature of the lead can also be measured using a thermocouple placed on the lead as close as possible to the tie point. The thermal mass connected to the tie point is normally large enough so that it will not significantly respond to heat surges generated in the diode as a result of pulsed operation once steady-state conditions are achieved. Using the measured value of T_L , the junction temperature may be determined by:

$$T_J = T_L + \Delta T_{JL}$$

ΔT_{JL} is the increase in junction temperature above the lead temperature and may be found from Figure 2 for a train of power pulses ($L = 3/8$ inch) or from Figure 10 for dc power.

$$\Delta T_{JL} = \theta_{JL} P_D$$

For worst-case design, using expected limits of I_Z , limits of P_D and the extremes of T_J (ΔT_J) may be estimated. Changes in voltage, V_Z , can then be found from:

$$\Delta V = \theta_{VZ} \Delta T_J$$

θ_{VZ} , the zener voltage temperature coefficient, is found from Figures 5 and 6.

Under high power-pulse operation, the zener voltage will vary with time and may also be affected significantly by the zener resistance. For best regulation, keep current excursions as low as possible.

Data of Figure 2 should not be used to compute surge capability. Surge limitations are given in Figure 3. They are lower than would be expected by considering only junction temperature, as current crowding effects cause temperatures to be extremely high in small spots resulting in device degradation should the limits of Figure 3 be exceeded.

GENERAL DATA — 500 mW DO-35 GLASS

TEMPERATURE COEFFICIENT RANGES (90% of the Units are in the Ranges Indicated)

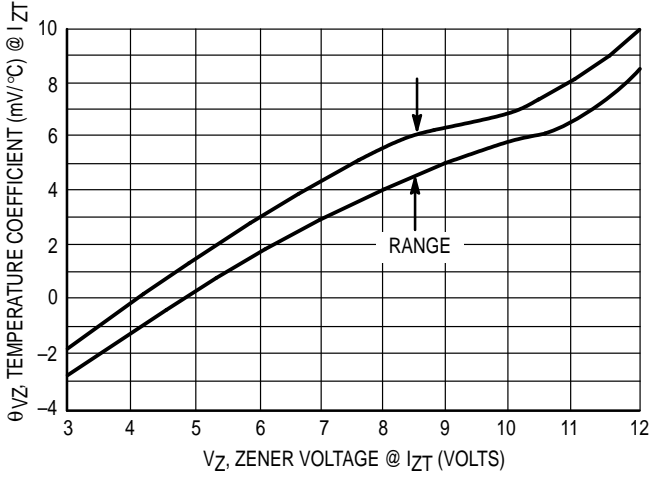

Figure 5. Units To 12 Volts

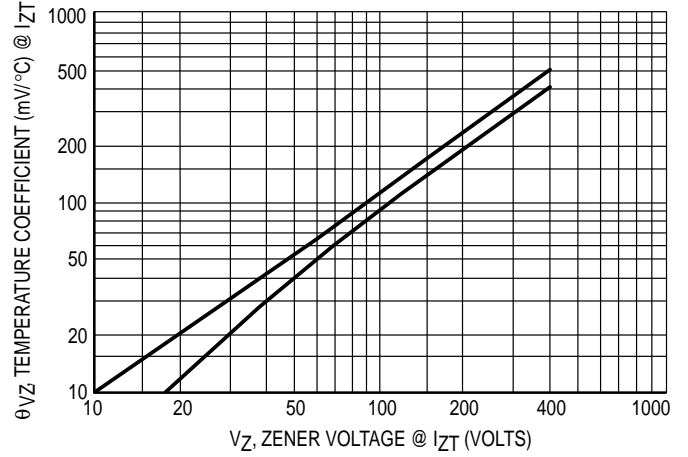

Figure 6. Units 10 To 400 Volts

ZENER VOLTAGE versus ZENER CURRENT (Figures 7, 8 and 9)

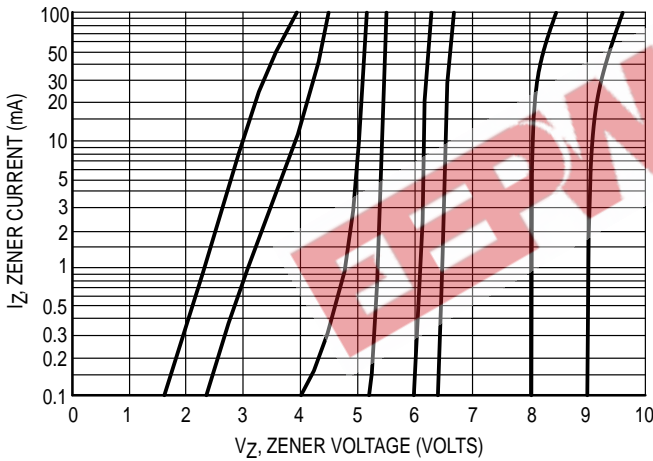

Figure 7. $V_Z = 3.3$ thru 10 Volts

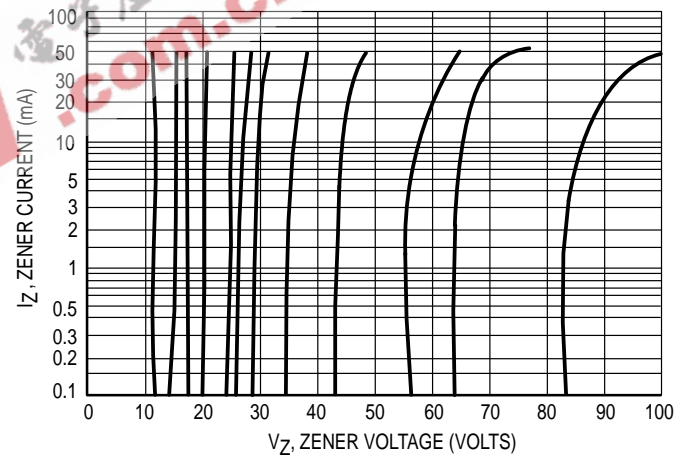

Figure 8. $V_Z = 12$ thru 82 Volts

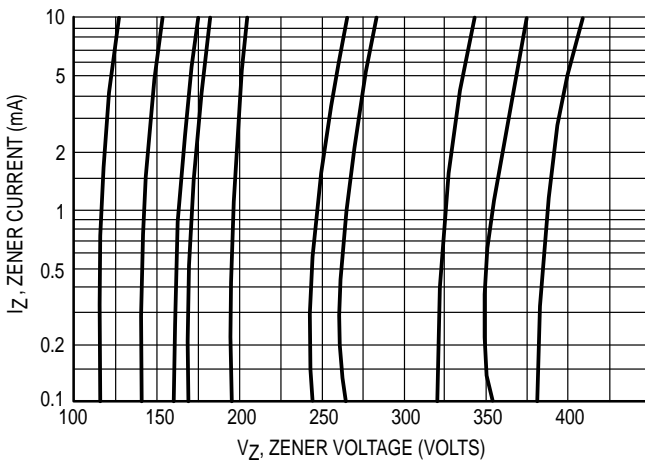

Figure 9. $V_Z = 100$ thru 400 Volts

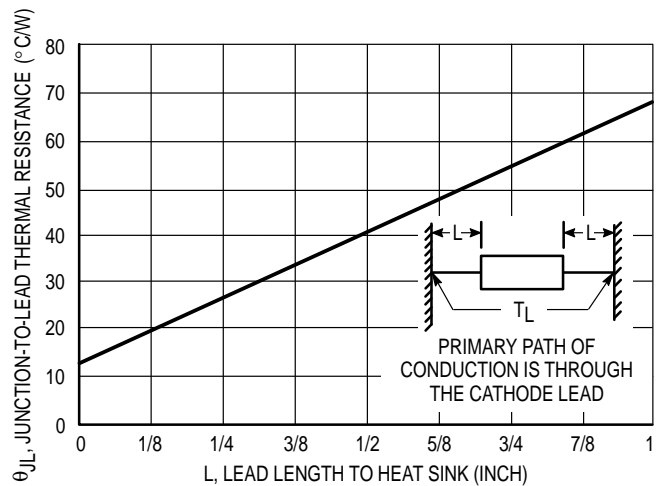

Figure 10. Typical Thermal Resistance

GENERAL DATA — 500 mW DO-35 GLASS

*MAXIMUM RATINGS

Rating	Symbol	Value	Unit
DC Power Dissipation @ $T_L = 75^\circ\text{C}$, Lead Length = 3/8" Derate above 75°C	P_D	1.5 12	Watts mW/ $^\circ\text{C}$

*ELECTRICAL CHARACTERISTICS ($T_L = 30^\circ\text{C}$ unless otherwise noted. $V_F = 1.5$ Volts Max @ $I_F = 200$ mAdc for all types.)

Motorola Type Number (Note 1)	Nominal Zener Voltage V_Z @ I_{ZT} Volts (Note 2 and 3)	Test Current I_{ZT} mA	Max. Zener Impedance (Note 4)			Max. Reverse Leakage Current		Maximum DC Zener Current I_{ZM} mAdc
			Z_{ZT} @ I_{ZT} Ohms	Z_{ZK} Ohms @	I_{ZK} mA	I_R @ V_R μA Volts		
1N5913B	3.3	113.6	10	500	1	100	1	454
1N5914B	3.6	104.2	9	500	1	75	1	416
1N5915B	3.9	96.1	7.5	500	1	25	1	384
1N5916B	4.3	87.2	6	500	1	5	1	348
1N5917B	4.7	79.8	5	500	1	5	1.5	319
1N5918B	5.1	73.5	4	350	1	5	2	294
1N5919B	5.6	66.9	2	250	1	5	3	267
1N5920B	6.2	60.5	2	200	1	5	4	241
1N5921B	6.8	55.1	2.5	200	1	5	5.2	220
1N5922B	7.5	50	3	400	0.5	5	6	200
1N5923B	8.2	45.7	3.5	400	0.5	5	6.5	182
1N5924B	9.1	41.2	4	500	0.5	5	7	164
1N5925B	10	37.5	4.5	500	0.25	5	8	150
1N5926B	11	34.1	5.5	550	0.25	1	8.4	136
1N5927B	12	31.2	6.5	550	0.25	1	9.1	125
1N5928B	13	28.8	7	550	0.25	1	9.9	115
1N5929B	15	25	9	600	0.25	1	11.4	100
1N5930B	16	23.4	10	600	0.25	1	12.2	93
1N5931B	18	20.8	12	650	0.25	1	13.7	83
1N5932B	20	18.7	14	650	0.25	1	15.2	75
1N5933B	22	17	17.5	650	0.25	1	16.7	68
1N5934B	24	15.6	19	700	0.25	1	18.2	62
1N5935B	27	13.9	23	700	0.25	1	20.6	55
1N5936B	30	12.5	26	750	0.25	1	22.8	50
1N5937B	33	11.4	33	800	0.25	1	25.1	45
1N5938B	36	10.4	38	850	0.25	1	27.4	41
1N5939B	39	9.6	45	900	0.25	1	29.7	38
1N5940B	43	8.7	53	950	0.25	1	32.7	34
1N5941B	47	8	67	1000	0.25	1	35.8	31
1N5942B	51	7.3	70	1100	0.25	1	38.8	29
1N5943B	56	6.7	86	1300	0.25	1	42.6	26
1N5944B	62	6	100	1500	0.25	1	47.1	24
1N5945B	68	5.5	120	1700	0.25	1	51.7	22
1N5946B	75	5	140	2000	0.25	1	56	20
1N5947B	82	4.6	160	2500	0.25	1	62.2	18

(continued)

*Indicates JEDEC Registered Data.

GENERAL DATA — 500 mW DO-35 GLASS

***ELECTRICAL CHARACTERISTICS — continued** ($T_L = 30^\circ\text{C}$ unless otherwise noted. $V_F = 1.5$ Volts Max @ $I_F = 200$ mAdc for all types.)

Motorola Type Number (Note 1)	Nominal Zener Voltage V_Z @ I_{ZT} Volts (Note 2 and 3)	Test Current I_{ZT} mA	Max. Zener Impedance (Note 4)			Max. Reverse Leakage Current		Maximum DC Zener Current I_{ZM} mAdc
			Z_{ZT} @ I_{ZT} Ohms	Z_{ZK} Ohms @ I_{ZK} mA	I_R @ V_R μA Volts			
1N5948B	91	4.1	200	3000	0.25	1	69.2	16
1N5949B	100	3.7	250	3100	0.25	1	76	15
1N5950B	110	3.4	300	4000	0.25	1	83.6	13
1N5951B	120	3.1	380	4500	0.25	1	91.2	12
1N5952B	130	2.9	450	5000	0.25	1	98.8	11
1N5953B	150	2.5	600	6000	0.25	1	114	10
1N5954B	160	2.3	700	6500	0.25	1	121.6	9
1N5955B	180	2.1	900	7000	0.25	1	136.8	8
1N5956B	200	1.9	1200	8000	0.25	1	152	7

*Indicates JEDEC Registered Data.

NOTE 1. TOLERANCE AND VOLTAGE DESIGNATION

Tolerance designation — Device tolerances of $\pm 5\%$ are indicated by a "B" suffix.

NOTE 2. SPECIAL SELECTIONS AVAILABLE INCLUDE:

Nominal zener voltages between those shown and $\pm 1\%$ and $\pm 2\%$ tight voltage tolerances. Consult factory.

NOTE 3. ZENER VOLTAGE (V_Z) MEASUREMENT

Motorola guarantees the zener voltage when measured at 90 seconds while maintaining the lead temperature (T_L) at $30^\circ\text{C} \pm 1^\circ\text{C}$, 3/8" from the diode body.

NOTE 4. ZENER IMPEDANCE (Z_Z) DERIVATION

The zener impedance is derived from the 60 cycle ac voltage, which results when an ac current having an rms value equal to 10% of the dc zener current (I_{ZT} or I_{ZK}) is superimposed on I_{ZT} or I_{ZK} .



GENERAL DATA — 500 mW DO-35 GLASS

ELECTRICAL CHARACTERISTICS ($T_A = 25^\circ\text{C}$ unless otherwise noted) $V_F = 1.5\text{ V Max}$, $I_F = 200\text{ mA}$ for all types)

Motorola Type No. (Note 1)	Nominal Zener Voltage $V_Z @ I_{ZT}$ Volts (Note 2)	Test Current I_{ZT} mA	Max Zener Impedance (Note 3)			Leakage Current		Maximum Zener Current I_{ZM} mA	Surge Current @ $T_A = 25^\circ\text{C}$ $i_r - \text{mA}$ (Note 4)
			$Z_{ZT} @ I_{ZT}$ Ohms	$Z_{ZK} @ I_{ZK}$ Ohms	I_{ZK} mA	$I_R @ V_R$ $\mu\text{A Max}$ Volts			
3EZ3.9D5 3EZ4.3D5	3.9 4.3	192 174	4.5 4.5	400 400	1 1	80 30	1 1	630 590	4.4 4.1
3EZ4.7D5 3EZ5.1D5	4.7 5.1	160 147	4 3.5	500 550	1 1	20 5	1 1	550 520	3.8 3.5
3EZ5.6D5 3EZ6.2D5 3EZ6.8D5 3EZ7.5D5	5.6 6.2 6.8 7.5	134 121 110 100	2.5 1.5 2 2	600 700 700 700	1 1 1 0.5	5 5 5 5	2 3 4 5	480 435 393 360	3.3 3.1 2.9 2.66
3EZ8.2D5 3EZ9.1D5 3EZ10D5 3EZ11D5	8.2 9.1 10 11	91 82 75 68	2.3 2.5 3.5 4	700 700 700 700	0.5 0.5 0.25 0.25	5 3 3 1	6 7 7.6 8.4	330 297 270 245	2.44 2.2 2 1.82
3EZ12D5 3EZ13D5 3EZ14D5 3EZ15D5	12 13 14 15	63 58 53 50	4.5 4.5 5 5.5	700 700 700 700	0.25 0.25 0.25 0.25	1 0.5 0.5 0.5	9.1 9.9 10.6 11.4	225 208 193 180	1.66 1.54 1.43 1.33
3EZ16D5 3EZ17D5 3EZ18D5 3EZ19D5	16 17 18 19	47 44 42 40	5.5 6 6 7	700 750 750 750	0.25 0.25 0.25 0.25	0.5 0.5 0.5 0.5	12.2 13 13.7 14.4	169 159 150 142	1.25 1.18 1.11 1.05
3EZ20D5 3EZ22D5 3EZ24D5 3EZ27D5	20 22 24 27	37 34 31 28	7 8 9 10	750 750 750 750	0.25 0.25 0.25 0.25	0.5 0.5 0.5 0.5	15.2 16.7 18.2 20.6	135 123 112 100	1 0.91 0.83 0.74
3EZ28D5 3EZ30D5 3EZ33D5 3EZ36D5	28 30 33 36	27 25 23 21	12 16 20 22	750 1000 1000 1000	0.25 0.25 0.25 0.25	0.5 0.5 0.5 0.5	21 22.5 25.1 27.4	96 90 82 75	0.71 0.67 0.61 0.56
3EZ39D5 3EZ43D5 3EZ47D5 3EZ51D5	39 43 47 51	19 17 16 15	28 33 38 45	1000 1500 1500 1500	0.25 0.25 0.25 0.25	0.5 0.5 0.5 0.5	29.7 32.7 35.6 38.8	69 63 57 53	0.51 0.45 0.42 0.39
3EZ56D5 3EZ62D5 3EZ68D5 3EZ75D5	56 62 68 75	13 12 11 10	50 55 70 85	2000 2000 2000 2000	0.25 0.25 0.25 0.25	0.5 0.5 0.5 0.5	42.6 47.1 51.7 56	48 44 40 36	0.36 0.32 0.29 0.27
3EZ82D5 3EZ91D5 3EZ100D5 3EZ110D5	82 91 100 110	9.1 8.2 7.5 6.8	95 115 160 225	3000 3000 3000 4000	0.25 0.25 0.25 0.25	0.5 0.5 0.5 0.5	62.2 69.2 76 83.6	33 30 27 25	0.24 0.22 0.2 0.18
3EZ120D5 3EZ130D5 3EZ140D5 3EZ150D5	120 130 140 150	6.3 5.8 5.3 5	300 375 475 550	4500 5000 5000 6000	0.25 0.25 0.25 0.25	0.5 0.5 0.5 0.5	91.2 98.8 106.4 114	22 21 19 18	0.16 0.15 0.14 0.13
3EZ160D5 3EZ170D5 3EZ180D5 3EZ190D5	160 170 180 190	4.7 4.4 4.2 4	625 650 700 800	6500 7000 7000 8000	0.25 0.25 0.25 0.25	0.5 0.5 0.5 0.5	121.6 130.4 136.8 144.8	17 16 15 14	0.12 0.12 0.11 0.1

(continued)

GENERAL DATA — 500 mW DO-35 GLASS

ELECTRICAL CHARACTERISTICS — continued ($T_A = 25^\circ\text{C}$ unless otherwise noted) $V_F = 1.5\text{ V Max}$, $I_F = 200\text{ mA}$ for all types)

Motorola Type No. (Note 1)	Nominal Zener Voltage V_Z @ I_{ZT} Volts (Note 2)	Test Current I_{ZT} mA	Max Zener Impedance (Note 3)			Leakage Current		Maximum Zener Current I_{ZM} mA	Surge Current @ $T_A = 25^\circ\text{C}$ $i_r - \text{mA}$ (Note 4)
			Z_{ZT} @ I_{ZT} Ohms	Z_{ZK} @ I_{ZK} Ohms	I_{ZK} mA	I_R @ V_R $\mu\text{A Max}$ Volts			
3EZ200D5	200	3.7	875	8000	0.25	0.5	152	13	0.1
3EZ220D5	220	3.4	1600	9000	0.25	1	167	12	0.09
3EZ240D5	240	3.1	1700	9000	0.25	1	182	11	0.09
3EZ270D5	270	2.8	1800	9000	0.25	1	205	10	0.08
3EZ300D5	300	2.5	1900	9000	0.25	1	228	9	0.07
3EZ330D5	330	2.3	2200	9000	0.25	1	251	8	0.06
3EZ360D5	360	2.1	2700	9000	0.25	1	274	8	0.06
3EZ400D5	400	1.9	3500	9000	0.25	1	304	7	0.06

NOTE 1. TOLERANCES

Suffix 5 indicates 5% tolerance. Any other tolerance will be considered as a special device.

NOTE 2. ZENER VOLTAGE (V_Z) MEASUREMENT

Motorola guarantees the zener voltage when measured at 40 ms \pm 10 ms 3/8" from the diode body, and an ambient temperature of 25°C (+8°C, -2°C)

NOTE 3. ZENER IMPEDANCE (Z_Z) DERIVATION

The zener impedance is derived from the 60 cycle ac voltage, which results when an ac current having an rms value equal to 10% of the dc zener current (I_{ZT} or I_{ZK}) is superimposed on I_{ZT} or I_{ZK} .

NOTE 4. SURGE CURRENT (i_r) NON-REPETITIVE

The rating listed in the electrical characteristics table is maximum peak, non-repetitive, reverse surge current of 1/2 square wave or equivalent sine wave pulse of 1/120 second duration superimposed on the test current, I_{ZT} , per JEDEC standards, however, actual device capability is as described in Figure 3 of General Data sheet for Surmetic 30s.

NOTE 5. SPECIAL SELECTIONS AVAILABLE INCLUDE:

Nominal zener voltages between those shown. Tight voltage tolerances such as $\pm 1\%$ and $\pm 2\%$. Consult factory.

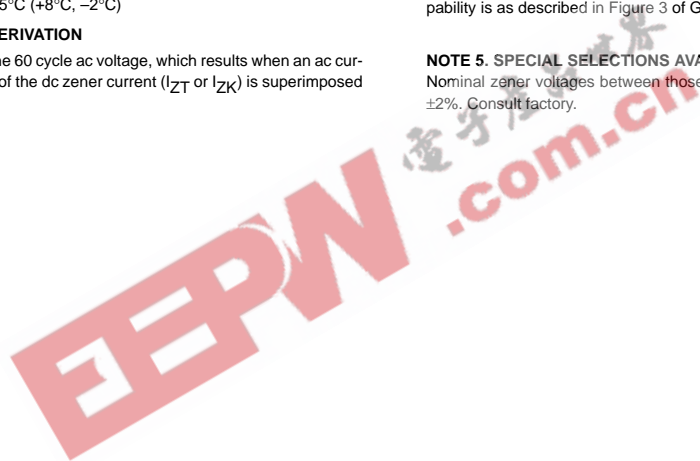

GENERAL DATA — 500 mW DO-35 GLASS

ELECTRICAL CHARACTERISTICS ($T_A = 25^\circ\text{C}$ unless otherwise noted.) $V_F = 1.5\text{ V Max}$, $I_F = 200\text{ mA}$ for all types.

Type No. (Note 1)	Zener Voltage (Note 2)		Test Current I_{ZT} mA	Zener Impedance at I_{ZT} $f = 1000\text{ Hz (Ohm)}$		Blocking Voltage $I_R = 1\ \mu\text{A}$	Typical T_C %/°C	Surge Current @ $T_L = 25^\circ\text{C}$ $i_r - \text{mA}$ (Note 3)
	Min	Max		Typ	Max			
MZD3.9	3.7	4.1	100	3.8	7	—	-0.06	1380
MZD4.3	4	4.6	100	3.8	7	—	0.055	1260
MZD4.7	4.4	5	100	3.8	7	—	0.03	1190
MZD5.1	4.8	5.4	100	2	5	—	0.03	1070
MZD5.6	5.2	6	100	1	2	1.5	+0.038	970
MZD6.2	5.8	6.6	100	1	2	1.5	+0.045	890
MZD6.8	6.4	7.2	100	1	2	2	+0.05	810
MZD7.5	7	7.9	100	1	2	2	+0.058	730
MZD8.2	7.7	8.7	100	1	2	3.5	+0.062	660
MZD9.1	8.5	9.6	50	2	4	3.5	+0.068	605
MZD10	9.4	10.6	50	2	4	5	+0.075	550
MZD11	10.4	11.6	50	4	7	5	+0.076	500
MZD12	11.4	12.7	50	4	7	7	+0.077	454
MZD13	12.4	14.1	50	5	10	7	+0.079	414
MZD15	13.8	15.8	50	5	10	10	+0.082	380
MZD16	15.3	17.1	25	6	15	10	+0.083	344
MZD18	16.8	19.1	25	6	15	10	+0.085	304
MZD20	18.8	21.2	25	6	15	10	+0.086	285
MZD22	20.8	23.3	25	6	15	12	+0.087	250
MZD24	22.8	25.6	25	7	15	12	+0.088	225
MZD27	25.1	28.9	25	7	15	14	+0.09	205
MZD30	28	32	25	8	15	14	+0.091	190
MZD33	31	35	25	8	15	17	+0.092	170
MZD36	34	38	10	21	40	17	+0.093	150
MZD39	37	41	10	21	40	20	+0.094	135
MZD43	40	46	10	24	45	20	+0.095	125
MZD47	44	50	10	24	45	24	+0.095	115
MZD51	48	54	10	25	60	24	+0.096	110
MZD56	52	60	10	25	60	28	+0.096	95
MZD62	58	66	10	25	80	28	+0.097	90
MZD68	64	72	10	25	80	34	+0.097	80
MZD75	70	79	10	30	100	34	+0.098	70
MZD82	77	88	10	30	100	41	+0.098	65
MZD91	85	96	5	60	200	41	+0.099	60
MZD100	94	106	5	60	200	50	+0.11	55
MZD110	104	116	5	80	250	50	+0.11	50
MZD120	114	127	5	80	250	60	+0.11	45
MZD130	124	141	5	110	300	60	+0.11	—
MZD150	138	156	5	110	300	75	+0.11	—
MZD160	153	171	5	150	350	75	+0.11	—
MZD180	168	191	5	150	350	90	+0.11	—
MZD200	188	212	5	150	350	90	+0.11	—

NOTE 1. TOLERANCE AND TYPE NUMBER DESIGNATION

The type numbers listed have zener voltage min/max limits as shown.

NOTE 2. ZENER VOLTAGE (V_Z) MEASUREMENT

The zener voltage is measured after the test current (I_{ZT}) has been applied for 40 ± 10 milliseconds, while maintaining a lead temperature (T_L) of 30°C at a point of 10 mm from the diode body.

NOTE 3. (i_r) NON-REPETITIVE SURGE CURRENT

Maximum peak, non-repetitive reverse surge current of half square wave or equivalent sine wave pulse of 50 ms duration, superimposed on the test current (I_{ZT}).

NOTE 4. SPECIAL SELECTIONS AVAILABLE INCLUDE:

Nominal zener voltages between those shown. Tight voltage tolerances such as $\pm 1\%$ and $\pm 2\%$. Consult factory.

GENERAL DATA — 500 mW DO-35 GLASS

ELECTRICAL CHARACTERISTICS ($T_A = 25^\circ\text{C}$ unless otherwise noted) $V_F = 1.5\text{ V Max}$, $I_F = 200\text{ mA}$ for all types

Motorola Type No. (Note 1)	Nominal Zener Voltage V_Z @ I_{ZT} Volts (Note 2)	Test Current I_{ZT} mA	Max Zener Impedance (Note 3)			Leakage Current		Surge Current @ $T_A = 25^\circ\text{C}$ i_r - mA (Note 4)
			Z_{ZT} @ I_{ZT} Ohms	Z_{ZK} @ I_{ZK} Ohms	I_{ZK} mA	I_R @ V_R $\mu\text{A Max}$ Volts		
MZP4728A	3.3	76	10	400	1	100	1	1380
MZP4729A	3.6	69	10	400	1	100	1	1260
MZP4730A	3.9	64	9	400	1	50	1	1190
MZP4731A	4.3	58	9	400	1	10	1	1070
MZP4732A	4.7	53	8	500	1	10	1	970
MZP4733A	5.1	49	7	550	1	10	1	890
MZP4734A	5.6	45	5	600	1	10	2	810
MZP4735A	6.2	41	2	700	1	10	3	730
MZP4736A	6.8	37	3.5	700	1	10	4	660
MZP4737A	7.5	34	4	700	0.5	10	5	605
MZP4738A	8.2	31	4.5	700	0.5	10	6	550
MZP4739A	9.1	28	5	700	0.5	10	7	500
MZP4740A	10	25	7	700	0.25	10	7.6	454
MZP4741A	11	23	8	700	0.25	5	8.4	414
MZP4742A	12	21	9	700	0.25	5	9.1	380
MZP4743A	13	19	10	700	0.25	5	9.9	344
MZP4744A	15	17	14	700	0.25	5	11.4	304
MZP4745A	16	15.5	16	700	0.25	5	12.2	285
MZP4746A	18	14	20	750	0.25	5	13.7	250
MZP4747A	20	12.5	22	750	0.25	5	15.2	225
MZP4748A	22	11.5	23	750	0.25	5	16.7	205
MZP4749A	24	10.5	25	750	0.25	5	18.2	190
MZP4750A	27	9.5	35	750	0.25	5	20.6	170
MZP4751A	30	8.5	40	1000	0.25	5	22.8	150
MZP4752A	33	7.5	45	1000	0.25	5	25.1	135
MZP4753A	36	7	50	1000	0.25	5	27.4	125
MZP4754A	39	6.5	60	1000	0.25	5	29.7	115
MZP4755A	43	6	70	1500	0.25	5	32.7	110
MZP4756A	47	5.5	80	1500	0.25	5	35.8	95
MZP4757A	51	5	95	1500	0.25	5	38.8	90
MZP4758A	56	4.5	110	2000	0.25	5	42.6	80
MZP4759A	62	4	125	2000	0.25	5	47.1	70
MZP4760A	68	3.7	150	2000	0.25	5	51.7	65
MZP4761A	75	3.3	175	2000	0.25	5	56	60
MZP4762A	82	3	200	3000	0.25	5	62.2	55
MZP4763A	91	2.8	250	3000	0.25	5	69.2	50
MZP4764A	100	2.5	350	3000	0.25	5	76	45
1M110ZS5	110	2.3	450	4000	0.25	5	83.6	—
1M120ZS5	120	2	550	4500	0.25	5	91.2	—
1M130ZS5	130	1.9	700	5000	0.25	5	98.8	—
1M150ZS5	150	1.7	1000	6000	0.25	5	114	—
1M160ZS5	160	1.6	1100	6500	0.25	5	121.6	—
1M180ZS5	180	1.4	1200	7000	0.25	5	136.8	—
1M200ZS5	200	1.2	1500	8000	0.25	5	152	—

NOTE 1. TOLERANCE AND TYPE NUMBER DESIGNATION

The type numbers listed have a standard tolerance on the nominal zener voltage of $\pm 5\%$. The tolerance on the 1M type numbers is indicated by the digits following ZS in the part number. "5" indicates a $\pm 5\%$ V_Z tolerance.

NOTE 2. ZENER VOLTAGE (V_Z) MEASUREMENT

Motorola guarantees the zener voltage when measured at 90 seconds while maintaining the lead temperature (T_L) at $30^\circ\text{C} \pm 1^\circ\text{C}$, $3/8"$ from the diode body.

NOTE 3. ZENER IMPEDANCE (Z_Z) DERIVATION

The zener impedance is derived from the 60 cycle ac voltage, which results when an ac

current having an rms value equal to 10% of the dc zener current (I_{ZT} or I_{ZK}) is superimposed on I_{ZT} or I_{ZK} .

NOTE 4. SURGE CURRENT (i_r) NON-REPETITIVE

The rating listed in the electrical characteristics table is maximum peak, non-repetitive, reverse surge current of 1/2 square wave or equivalent sine wave pulse of 1/120 second duration superimposed on the test current, I_{ZT} , however, actual device capability is as described in Figure 3 of General Data — Surmetic 30.

NOTE 5. SPECIAL SELECTIONS AVAILABLE INCLUDE:

Nominal zener voltages between those shown. Tight voltage tolerances such as $\pm 1\%$ and $\pm 2\%$. Consult factory.

GENERAL DATA — 500 mW DO-35 GLASS

Zener Voltage Regulator Diodes — Axial Leaded

1–3 Watt DO-41 Surmetic 30

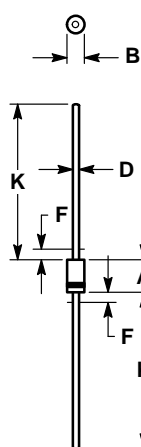

- NOTES:
1. ALL RULES AND NOTES ASSOCIATED WITH JEDEC DO-41 OUTLINE SHALL APPLY.
 2. POLARITY DENOTED BY CATHODE BAND.
 3. LEAD DIAMETER NOT CONTROLLED WITHIN F DIMENSION.

DIM	MILLIMETERS		INCHES	
	MIN	MAX	MIN	MAX
A	4.07	5.20	0.160	0.205
B	2.04	2.71	0.080	0.107
D	0.71	0.86	0.028	0.034
F	—	1.27	—	0.050
K	27.94	—	1.100	—

CASE 59-03
DO-41
PLASTIC

(Refer to Section 10 for Surface Mount, Thermal Data and Footprint Information.)

MULTIPLE PACKAGE QUANTITY (MPQ) REQUIREMENTS

Package Option	Type No. Suffix	MPQ (Units)
Tape and Reel	RL	6K
Tape and Ammo	TA	4K

(Refer to Section 10 for more information on Packaging Specifications.)

5 Watt Surmetic 40 Silicon Zener Diodes

This is a complete series of 5 Watt Zener Diodes with tight limits and better operating characteristics that reflect the superior capabilities of silicon-oxide-passivated junctions. All this is in an axial-lead, transfer-molded plastic package that offers protection in all common environmental conditions.

Specification Features:

- Up to 180 Watt Surge Rating @ 8.3 ms
- Maximum Limits Guaranteed on Seven Electrical Parameters

Mechanical Characteristics:

CASE: Void-free, transfer-molded, thermosetting plastic

FINISH: All external surfaces are corrosion resistant and leads are readily solderable

POLARITY: Cathode indicated by color band. When operated in zener mode, cathode will be positive with respect to anode

MOUNTING POSITION: Any

WEIGHT: 0.7 gram (approx)

WAFER FAB LOCATION: Phoenix, Arizona

ASSEMBLY/TEST LOCATION: Seoul, Korea

**1N5333B
through
1N5388B**

**5 WATT
ZENER REGULATOR
DIODES
3.3–200 VOLTS**

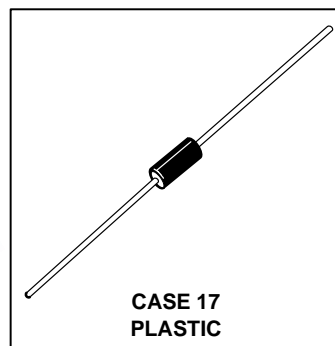

MAXIMUM RATINGS

Rating	Symbol	Value	Unit
DC Power Dissipation @ $T_L = 75^\circ\text{C}$ Lead Length = 3/8" Derate above 75°C	P_D	5 40	Watts mW/°C
Operating and Storage Junction Temperature Range	T_J, T_{stg}	-65 to +200	°C

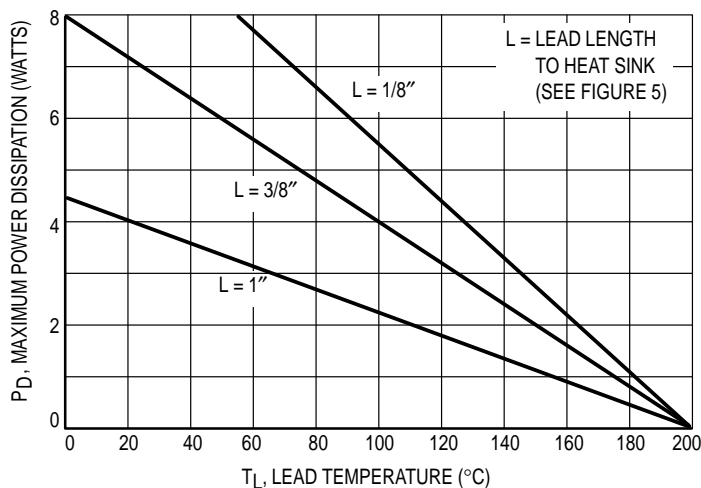

Figure 1. Power Temperature Derating Curve

1N5333B through 1N5388B

ELECTRICAL CHARACTERISTICS ($T_A = 25^\circ\text{C}$ unless otherwise noted, $V_F = 1.2$ Max @ $I_F = 1$ A for all types)

JEDEC Type No. (Note 1)	Nominal Zener Voltage V_Z @ I_{ZT} Volts (Note 2)	Test Current I_{ZT} mA	Max Zener Impedance		Max Reverse Leakage Current		Max Surge Current i_r , Amps (Note 3)	Max Voltage Regulation ΔV_Z , Volt (Note 4)	Maximum Regulator Current I_{ZM} mA (Note 5)
			Z_{ZT} @ I_{ZT} Ohms (Note 2)	Z_{ZK} @ $I_{ZK} = 1$ mA Ohms (Note 2)	I_R @ V_R μA Volts				
1N5333B	3.3	380	3	400	300	1	20	0.85	1440
1N5334B	3.6	350	2.5	500	150	1	18.7	0.8	1320
1N5335B	3.9	320	2	500	50	1	17.6	0.54	1220
1N5336B	4.3	290	2	500	10	1	16.4	0.49	1100
1N5337B	4.7	260	2	450	5	1	15.3	0.44	1010
1N5338B	5.1	240	1.5	400	1	1	14.4	0.39	930
1N5339B	5.6	220	1	400	1	2	13.4	0.25	865
1N5340B	6	200	1	300	1	3	12.7	0.19	790
1N5341B	6.2	200	1	200	1	3	12.4	0.1	765
1N5342B	6.8	175	1	200	10	5.2	11.5	0.15	700
1N5343B	7.5	175	1.5	200	10	5.7	10.7	0.15	630
1N5344B	8.2	150	1.5	200	10	6.2	10	0.2	580
1N5345B	8.7	150	2	200	10	6.6	9.5	0.2	545
1N5346B	9.1	150	2	150	7.5	6.9	9.2	0.22	520
1N5347B	10	125	2	125	5	7.6	8.6	0.22	475
1N5348B	11	125	2.5	125	5	8.4	8	0.25	430
1N5349B	12	100	2.5	125	2	9.1	7.5	0.25	395
1N5350B	13	100	2.5	100	1	9.9	7	0.25	365
1N5351B	14	100	2.5	75	1	10.6	6.7	0.25	340
1N5352B	15	75	2.5	75	1	11.5	6.3	0.25	315
1N5353B	16	75	2.5	75	1	12.2	6	0.3	295
1N5354B	17	70	2.5	75	0.5	12.9	5.8	0.35	280
1N5355B	18	65	2.5	75	0.5	13.7	5.5	0.4	265
1N5356B	19	65	3	75	0.5	14.4	5.3	0.4	250
1N5357B	20	65	3	75	0.5	15.2	5.1	0.4	237
1N5358B	22	50	3.5	75	0.5	16.7	4.7	0.45	216
1N5359B	24	50	3.5	100	0.5	18.2	4.4	0.55	198
1N5360B	25	50	4	110	0.5	19	4.3	0.55	190
1N5361B	27	50	5	120	0.5	20.6	4.1	0.6	176
1N5362B	28	50	6	130	0.5	21.2	3.9	0.6	170
1N5363B	30	40	8	140	0.5	22.8	3.7	0.6	158
1N5364B	33	40	10	150	0.5	25.1	3.5	0.6	144
1N5365B	36	30	11	160	0.5	27.4	3.3	0.65	132
1N5366B	39	30	14	170	0.5	29.7	3.1	0.65	122
1N5367B	43	30	20	190	0.5	32.7	2.8	0.7	110
1N5368B	47	25	25	210	0.5	35.8	2.7	0.8	100
1N5369B	51	25	27	230	0.5	38.8	2.5	0.9	93
1N5370B	56	20	35	280	0.5	42.6	2.3	1	86
1N5371B	60	20	40	350	0.5	42.5	2.2	1.2	79
1N5372B	62	20	42	400	0.5	47.1	2.1	1.35	76
1N5373B	68	20	44	500	0.5	51.7	2	1.5	70
1N5374B	75	20	45	620	0.5	56	1.9	1.6	63
1N5375B	82	15	65	720	0.5	62.2	1.8	1.8	58
1N5376B	87	15	75	760	0.5	66	1.7	2	54.5
1N5377B	91	15	75	760	0.5	69.2	1.6	2.2	52.5
1N5378B	100	12	90	800	0.5	76	1.5	2.5	47.5
1N5379B	110	12	125	1000	0.5	83.6	1.4	2.5	43
1N5380B	120	10	170	1150	0.5	91.2	1.3	2.5	39.5
1N5381B	130	10	190	1250	0.5	98.8	1.2	2.5	36.6
1N5382B	140	8	230	1500	0.5	106	1.2	2.5	34

(continued)

Devices listed in bold, italic are Motorola preferred devices.

1N5333B through 1N5388B

ELECTRICAL CHARACTERISTICS — continued ($T_A = 25^\circ\text{C}$ unless otherwise noted, $V_F = 1.2$ Max @ $I_F = 1$ A for all types)

JEDEC Type No. (Note 1)	Nominal Zener Voltage V_Z @ I_{ZT} Volts (Note 2)	Test Current I_{ZT} mA	Max Zener Impedance		Max Reverse Leakage Current		Max Surge Current i_r , Amps (Note 3)	Max Voltage Regulation ΔV_Z , Volt (Note 4)	Maximum Regulator Current I_{ZM} mA (Note 5)
			Z_{ZT} @ I_{ZT} Ohms (Note 2)	Z_{ZK} @ $I_{ZK} = 1$ mA Ohms (Note 2)	I_R @ V_R μA Volts				
1N5383B	150	8	330	1500	0.5	114	1.1	3	31.6
1N5384B	160	8	350	1650	0.5	122	1.1	3	29.4
1N5385B	170	8	380	1750	0.5	129	1	3	28
1N5386B	180	5	430	1750	0.5	137	1	4	26.4
1N5387B	190	5	450	1850	0.5	144	0.9	5	25
1N5388B	200	5	480	1850	0.5	152	0.9	5	23.6

NOTE 1. TOLERANCE AND TYPE NUMBER DESIGNATION
The JEDEC type numbers shown indicate a tolerance of $\pm 5\%$.

NOTE 2. ZENER VOLTAGE (V_Z) AND IMPEDANCE (Z_{ZT} & Z_{ZK})
Test conditions for zener voltage and impedance are as follows: I_Z is applied 40 ± 10 ms prior to reading. Mounting contacts are located $3/8''$ to $1/2''$ from the inside edge of mounting clips to the body of the diode. ($T_A = 25^\circ\text{C} +8, -2^\circ\text{C}$).

NOTE 3. SURGE CURRENT (i_r)
Surge current is specified as the maximum allowable peak, non-recurrent square-wave current with a pulse width, PW, of 8.3 ms. The data given in Figure 6 may be used to find the maximum surge current for a square wave of any pulse width between 1ms and 1000 ms by plotting the applicable points on logarithmic paper. Examples of this, using the 3.3 V and 200 V zeners, are shown in Figure 7. Mounting contact located as specified in Note 3. ($T_A = 25^\circ\text{C} +8, -2^\circ\text{C}$).

NOTE 4. VOLTAGE REGULATION (ΔV_Z)
Test conditions for voltage regulation are as follows: V_Z measurements are made at 10% and then at 50% of the I_Z max value listed in the electrical characteristics table. The test current time duration for each V_Z measurement is 40 ± 10 ms. ($T_A = 25^\circ\text{C} +8, -2^\circ\text{C}$). Mounting contact located as specified in Note 2.

NOTE 5. MAXIMUM REGULATOR CURRENT (I_{ZM})
The maximum current shown is based on the maximum voltage of a 5% type unit, therefore, it applies only to the B-suffix device. The actual I_{ZM} for any device may not exceed the value of 5 watts divided by the actual V_Z of the device. $T_L = 75^\circ\text{C}$ at $3/8''$ maximum from the device body.

NOTE 6. SPECIALS AVAILABLE INCLUDE:
Nominal zener voltages between the voltages shown and tighter voltage tolerance such as $\pm 1\%$ and $\pm 2\%$. Consult factory.

TEMPERATURE COEFFICIENTS

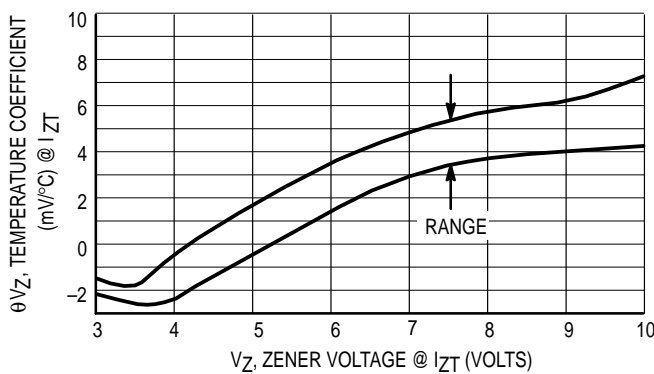

Figure 2. Temperature Coefficient-Range for Units 3 to 10 Volts

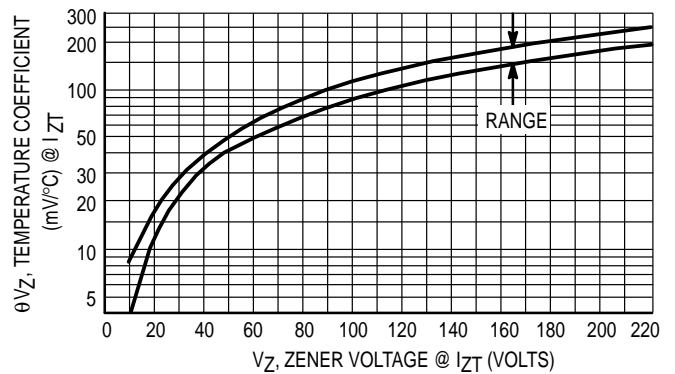

Figure 3. Temperature Coefficient-Range for Units 10 to 220 Volts

Devices listed in bold, italic are Motorola preferred devices.

1N5333B through 1N5388B

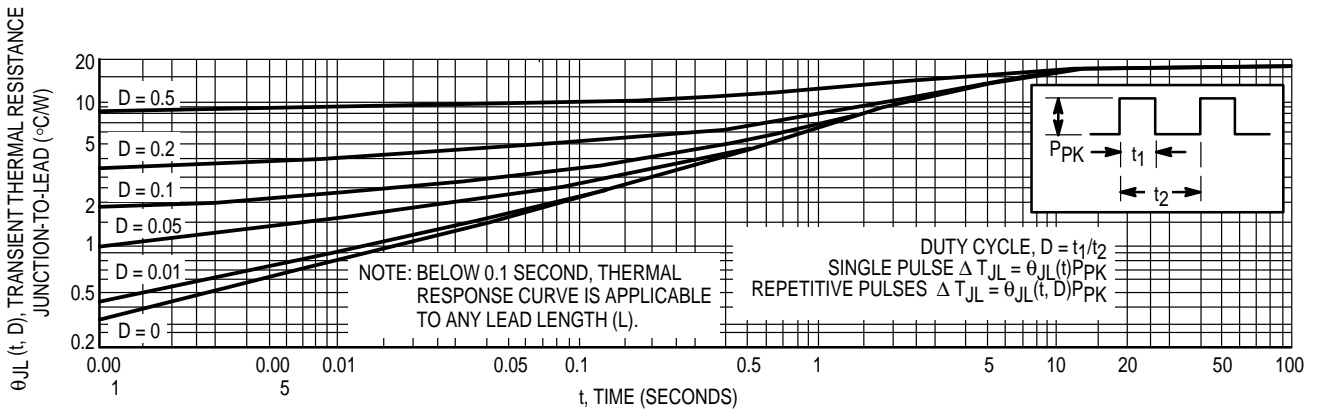

Figure 4. Typical Thermal Response
L, Lead Length = 3/8 Inch

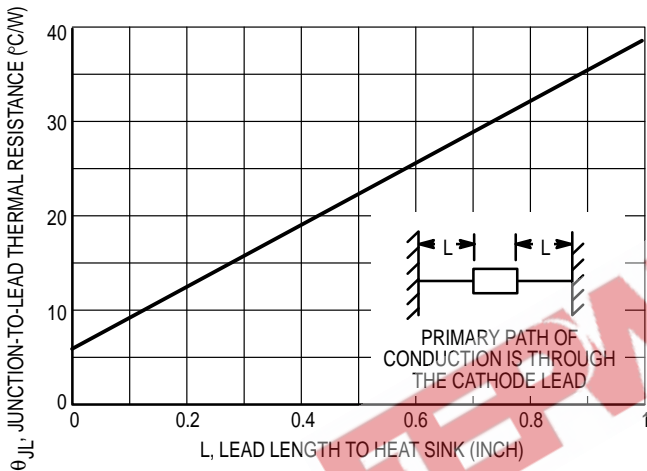

Figure 5. Typical Thermal Resistance

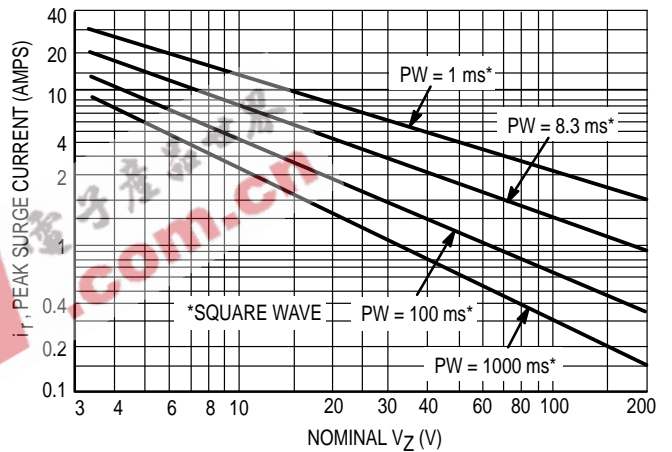

Figure 6. Maximum Non-Repetitive Surge Current versus Nominal Zener Voltage
(See Note 3)

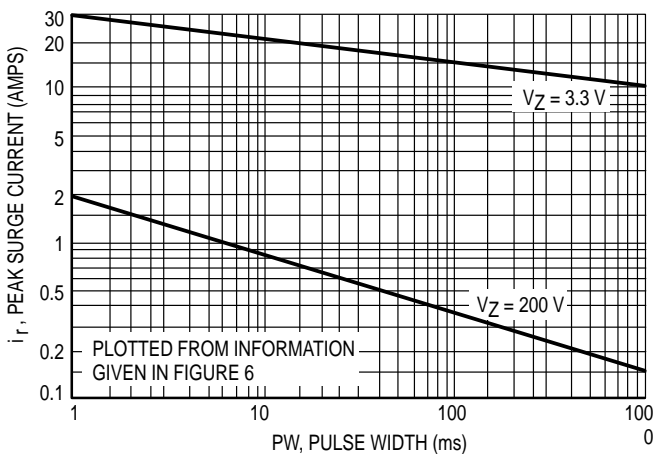

Figure 7. Peak Surge Current versus Pulse Width
(See Note 3)

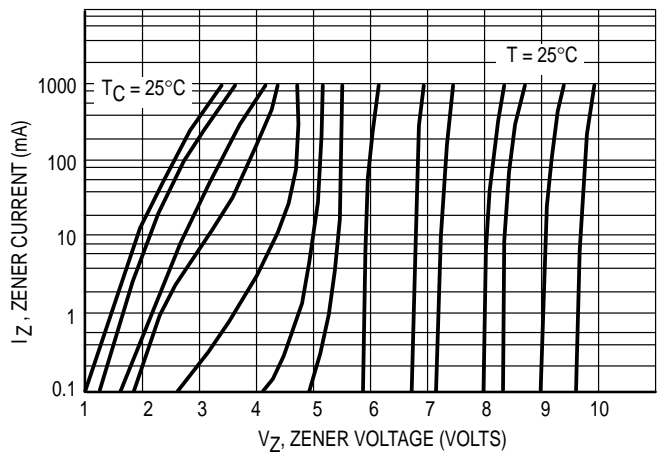

Figure 8. Zener Voltage versus Zener Current
V_Z = 3.3 thru 10 Volts

1N5333B through 1N5388B

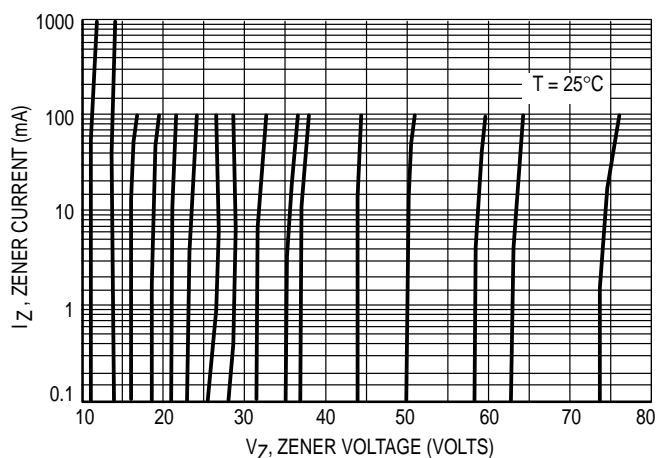

Figure 9. Zener Voltage versus Zener Current
V_Z = 11 thru 75 Volts

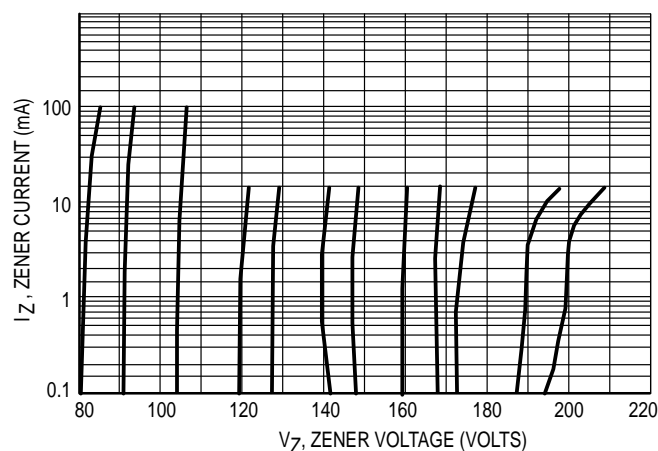

Figure 10. Zener Voltage versus Zener Current
V_Z = 82 thru 200 Volts

APPLICATION NOTE

Since the actual voltage available from a given zener diode is temperature dependent, it is necessary to determine junction temperature under any set of operating conditions in order to calculate its value. The following procedure is recommended:

Lead Temperature, T_L, should be determined from:

$$T_L = \theta_{LA} P_D + T_A$$

θ_{LA} is the lead-to-ambient thermal resistance and P_D is the power dissipation.

Junction Temperature, T_J, may be found from:

$$T_J = T_L + \Delta T_{JL}$$

ΔT_{JL} is the increase in junction temperature above the lead temperature and may be found from Figure 4 for a train of power pulses or from Figure 5 for dc power.

$$\Delta T_{JL} = \theta_{JL} P_D$$

For worst-case design, using expected limits of I_Z, limits of P_D and the extremes of T_J (ΔT_J) may be estimated. Changes in voltage, V_Z, can then be found from:

$$\Delta V = \theta_{VZ} \Delta T_J$$

θ_{VZ} , the zener voltage temperature coefficient, is found from Figures 2 and 3.

Under high power-pulse operation, the zener voltage will vary with time and may also be affected significantly by the zener resistance. For best regulation, keep current excursions as low as possible.

Data of Figure 4 should not be used to compute surge capability. Surge limitations are given in Figure 6. They are lower than would be expected by considering only junction temperature, as current crowding effects cause temperatures to be extremely high in small spots resulting in device degradation should the limits of Figure 6 be exceeded.

Zener Voltage Regulator Diodes — Axial Leaded

5 Watt Surmetic 40

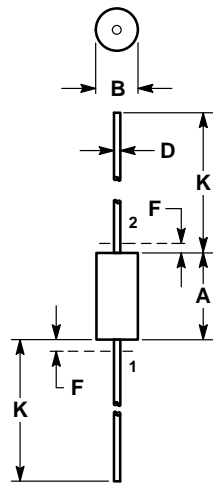

NOTE:
1. LEAD DIAMETER & FINISH NOT CONTROLLED WITHIN DIM F.

DIM	INCHES		MILLIMETERS	
	MIN	MAX	MIN	MAX
A	0.330	0.350	8.38	8.89
B	0.130	0.145	3.30	3.68
D	0.037	0.043	0.94	1.09
F	—	0.050	—	1.27
K	1.000	1.250	25.40	31.75

CASE 17-02
PLASTIC

(Refer to Section 10 for Surface Mount, Thermal Data and Footprint Information.)

MULTIPLE PACKAGE QUANTITY (MPQ) REQUIREMENTS

Package Option	Type No. Suffix	MPQ (Units)
Tape and Reel	RL	4K
Tape and Ammo	TA	2K

(Refer to Section 10 for more information on Packaging Specifications.)