

# DATA SHEET

## BZX55-C SERIES

### AXIAL LEAD ZENER DIODES

<b>VOLTAGE</b>	<b>2.4 to 47 Volts</b>	<b>POWER</b>	<b>500 mWatts</b>	<b>DO-35</b>	Unit: inch (mm)
----------------	------------------------	--------------	-------------------	--------------	-----------------

#### FEATURES

- Planar Die construction
- 500mW Power Dissipation
- Ideally Suited for Automated Assembly Processes
- Both normal and Pb free product are available :  
Normal : 80~95% Sn, 5~20% Pb  
Pb free: 98.5% Sn above

#### MECHANICAL DATA

- Case: Molded glass DO-35
- Terminals: Solderable per MIL-STD-202, Method 208
- Polarity: See Diagram Below
- Approx. Weight: 0.13 grams
- Mounting Position: Any
- Ordering information: Suffix :"-35" to order DO-35 Package
- Packing information

B - 2K per Bulk box  
T/R - 10K per 13" plastic Reel  
T/B - 5K per horiz. tape & Ammo box

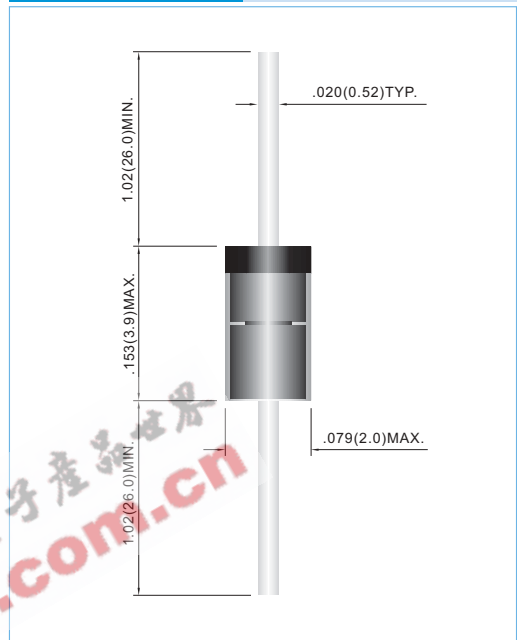

### MAXIMUM RATINGS AND ELECTRICAL CHARACTERISTICS (T<sub>J</sub>=25°C unless otherwise noted)

Parameter	Symbol	Value	Units
Power Dissipation at Tamb = 25 °C	P <sub>TOT</sub>	500	mW
Junction Temperature	T <sub>J</sub>	175	°C
Storage Temperature Range	T <sub>S</sub>	-65 to +175	°C

Valid provided that leads at a distance of 8mm from case are kept at ambient temperature.

Parameter	Symbol	Min.	Typ.	Max.	Units
Thermal Resistance Junction to Ambient Air	R <sub>thA</sub>	--	--	0.3	K/mW
Forward Voltage at I <sub>F</sub> = 100mA	V <sub>F</sub>	--	--	1	V

Valid provided that leads at a distance of 10 mm from case are kept at ambient temperature.

Part Number	Nominal Zener Voltage			Max. Zener Impedance				Max Reverse Leakage Current		marking code
	Vz @ IzT			ZzT @ IzT		Zzk @ IzK		Ir @ VR		
	Nom. V	Min. V	Max. V	$\Omega$	mA	$\Omega$	mA	$\mu$ A	V	
BZX55-C2V4	2.4	2.28	2.56	85	5.0	600	1.0	50	1.0	55C2V4
BZX55-C2V7	2.7	2.50	2.90	85	5.0	600	1.0	10	1.0	55C2V7
BZX55-C3V0	3.0	2.80	3.20	85	5.0	600	1.0	4.0	1.0	55C3V0
BZX55-C3V3	3.3	3.10	3.50	85	5.0	600	1.0	2.0	1.0	55C3V3
BZX55-C3V6	3.6	3.40	3.80	85	5.0	600	1.0	2.0	1.0	55C3V6
BZX55-C3V9	3.9	3.70	4.10	85	5.0	600	1.0	2.0	1.0	55C3V9
BZX55-C4V3	4.3	4.00	4.60	75	5.0	600	1.0	1.0	1.0	55C4V3
BZX55-C4V7	4.7	4.40	5.00	60	5.0	600	1.0	0.5	1.0	55C4V7
BZX55-C5V1	5.1	4.80	5.40	35	5.0	550	1.0	0.1	1.0	55C5V1
BZX55-C5V6	5.6	5.20	6.00	25	5.0	450	1.0	0.1	1.0	55C5V6
BZX55-C6V2	6.2	5.80	6.60	10	5.0	200	1.0	0.1	2.0	55C6V2
BZX55-C6V8	6.8	6.40	7.20	8	5.0	150	1.0	0.1	3.0	55C6V8
BZX55-C7V5	7.5	7.00	7.90	7	5.0	50	1.0	0.1	5.0	55C7V5
BZX55-C8V2	8.2	7.70	8.70	7	5.0	50	1.0	0.1	6.0	55C8V2
BZX55-C9V1	9.1	8.50	9.60	10	5.0	50	1.0	0.1	7.0	55C9V1
BZX55-C10	10.0	9.40	10.60	15	5.0	70	1.0	0.1	7.5	55C10V
BZX55-C11	11.0	10.40	11.60	20	5.0	70	1.0	0.1	8.5	55C11V
BZX55-C12	12.0	11.40	12.70	20	5.0	90	1.0	0.1	9.0	55C12V
BZX55-C13	13.0	12.40	14.10	26	5.0	110	1.0	0.1	10.0	55C13V
BZX55-C15	15.0	13.80	15.60	30	5.0	110	1.0	0.1	11.0	55C15V
BZX55-C16	16.0	15.30	17.10	40	5.0	170	1.0	0.1	12.0	55C16V
BZX55-C18	18.0	16.80	19.10	50	5.0	170	1.0	0.1	14.0	55C18V
BZX55-C20	20.0	18.80	21.20	55	5.0	220	1.0	0.1	15.0	55C20V
BZX55-C22	22.0	20.80	23.30	55	5.0	220	1.0	0.1	17.0	55C22V
BZX55-C24	24.0	22.80	25.60	80	5.0	220	1.0	0.1	18.0	55C24V
BZX55-C27	27.0	25.10	28.90	80	5.0	220	1.0	0.1	20.0	55C27V
BZX55-C30	30.0	28.00	32.00	80	5.0	220	1.0	0.1	22.0	55C30V
BZX55-C33	33.0	31.00	35.00	80	5.0	220	1.0	0.1	24.0	55C33V
BZX55-C36	36.0	34.00	38.00	80	5.0	220	1.0	0.1	27.0	55C36V
BZX55-C39	39.0	37.00	41.00	90	2.5	500	1.0	0.1	30.0	55C39V
BZX55-C43	43.0	40.00	46.00	90	2.5	600	1.0	0.1	33.0	55C43V
BZX55-C47	47.0	44.00	50.00	110	2.5	700	1.0	0.1	36.0	55C47V

**Typical Characteristics** ( $T_{amb} = 25\text{ }^{\circ}\text{C}$  unless otherwise specified)

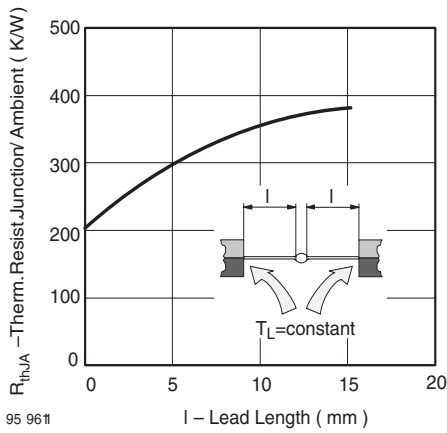

Fig. 1 Thermal Resistance vs. Lead Length

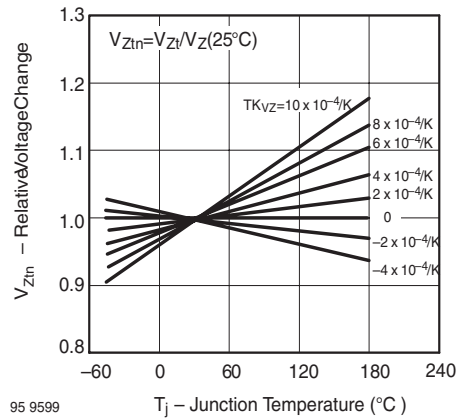

Fig. 4 Typical Change of Working Voltage vs. Junction Temperature

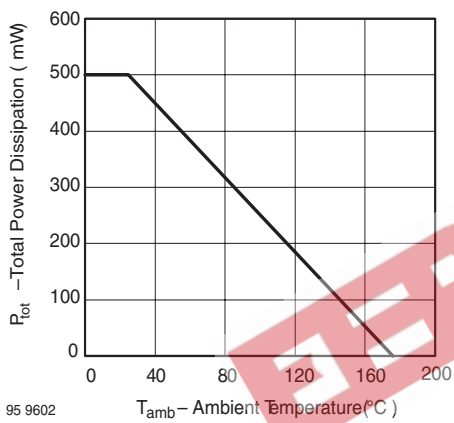

Fig. 2 Total Power Dissipation vs. Ambient Temperature

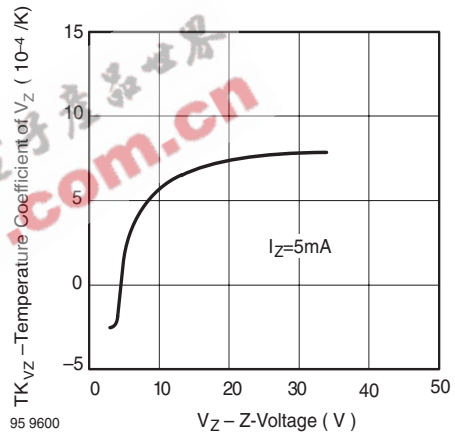

Fig. 5 Temperature Coefficient of  $V_Z$  vs. Z-Voltage

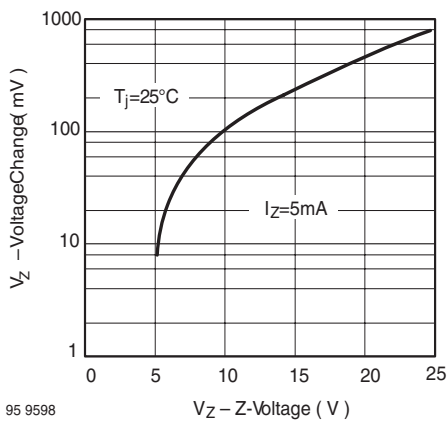

Fig. 3 Typical Change of Working Voltage under Operating Conditions at  $T_{amb}=25\text{ }^{\circ}\text{C}$

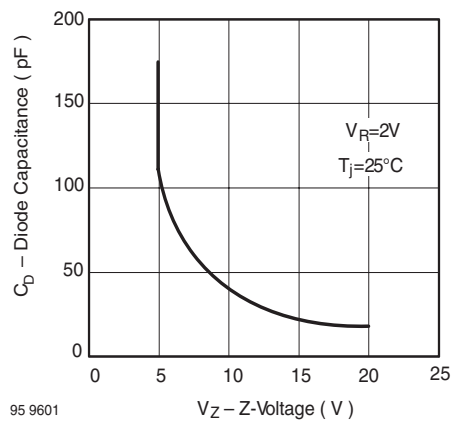

Fig. 6 Diode Capacitance vs. Z-Voltage

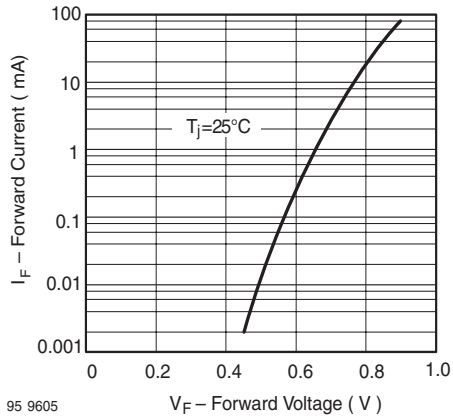

Fig. 7 Forward Current vs. Forward Voltage

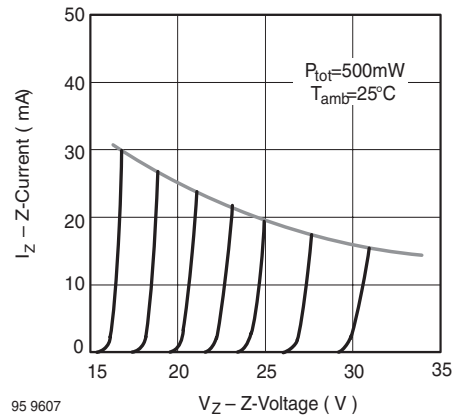

Fig. 9 Z-Current vs. Z-Voltage

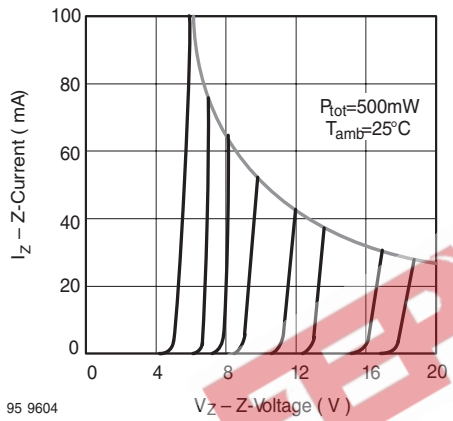

Fig. 8 Z-Current vs. Z-Voltage

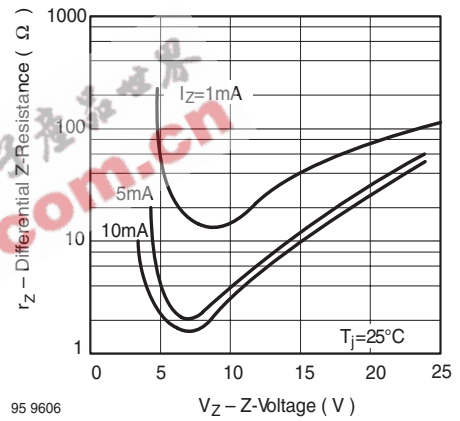

Fig. 10 Differential Z-Resistance vs. Z-Voltage

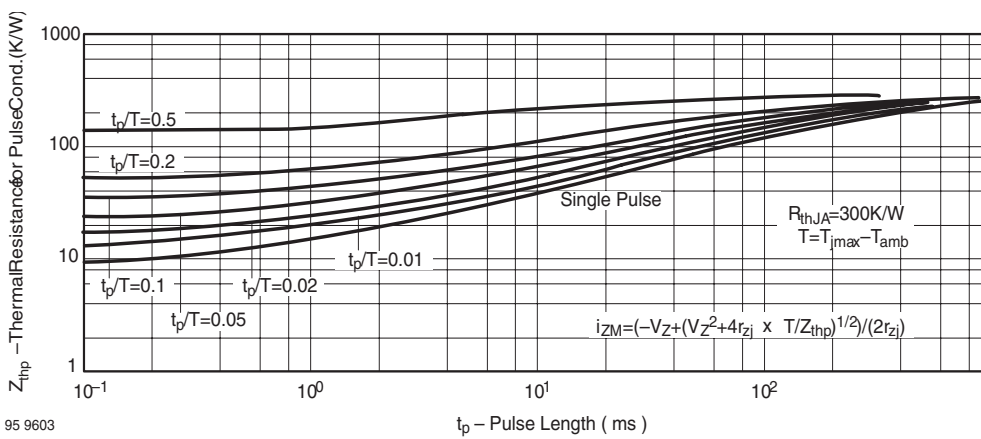

Fig. 11 Thermal Response