



BTA40, BTA41 and BTB41 Series

STANDARD

40A TRIACs

Table 1: Main Features

| Symbol | Value | Unit |
|-------------------|-------------|------|
| $I_{T(RMS)}$ | 40 | A |
| V_{DRM}/V_{RRM} | 600 and 800 | V |
| $I_{GT}(Q_1)$ | 50 | mA |

DESCRIPTION

Available in high power packages, the **BTA/BTB40-41** series is suitable for general purpose AC switching. They can be used as an ON/OFF function in applications such as static relays, heating regulation, induction motor starting circuits... or for phase control operation in light dimmers, motor speed controllers, ...

Thanks to their clip assembly technique, they provide a superior performance in surge current handling capabilities.

By using an internal ceramic pad, the BTA series provides voltage insulated tab (rated at $2500V_{RMS}$) complying with UL standards (File ref.: E81734).

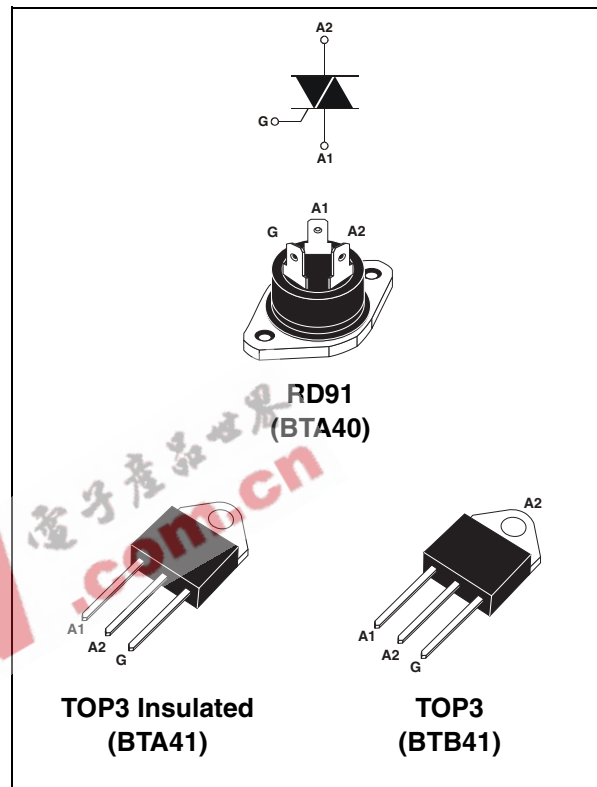

Table 2: Order Codes

| Part Number | Marking |
|--------------|-----------------------|
| BTA40-xxxB | See table 8 on page 6 |
| BTA41-xxxBRG | |
| BTB41-xxxBRG | |

BTA40, BTA41 and BTB41 Series

Table 3: Absolute Maximum Ratings

| Symbol | Parameter | | | Value | Unit |
|--------------------|--|--------------------------|---------------------------|--------------------------------|------------------------|
| $I_{T(RMS)}$ | RMS on-state current (full sine wave) | RD91 / TOP3 | $T_c = 95^\circ\text{C}$ | 40 | A |
| | | TOP Ins. | $T_c = 80^\circ\text{C}$ | | |
| I_{TSM} | Non repetitive surge peak on-state current (full cycle, T_j initial = 25°C) | F = 50 Hz | t = 20 ms | 400 | A |
| | | F = 60 Hz | t = 16.7 ms | 420 | |
| I^2t | I^2t Value for fusing | $t_p = 10$ ms | | 880 | A^2s |
| di/dt | Critical rate of rise of on-state current $I_G = 2 \times I_{GT}$, $t_r \leq 100$ ns | F = 120 Hz | $T_j = 125^\circ\text{C}$ | 50 | $\text{A}/\mu\text{s}$ |
| V_{DSM}/V_{RSM} | Non repetitive surge peak off-state voltage | $t_p = 10$ ms | $T_j = 25^\circ\text{C}$ | $V_{DSM}/V_{RSM} + 100$ | V |
| I_{GM} | Peak gate current | $t_p = 20$ μs | $T_j = 125^\circ\text{C}$ | 8 | A |
| $P_{G(AV)}$ | Average gate power dissipation | | $T_j = 125^\circ\text{C}$ | 1 | W |
| T_{stg} T_j | Storage junction temperature range Operating junction temperature range | | | - 40 to + 150 - 40 to + 125 | $^\circ\text{C}$ |

Tables 4: Electrical Characteristics ($T_j = 25^\circ\text{C}$, unless otherwise specified)

| Symbol | Test Conditions | Quadrant | Value | Unit |
|--------------------------|--|---------------------------|-------------------|------------------------|
| I_{GT} (1) | $V_D = 12$ V $R_L = 33$ Ω | I - II - III IV | MAX. 50 100 | mA |
| V_{GT} | | ALL | MAX. 1.3 | V |
| V_{GD} | $V_D = V_{DRM}$ $R_L = 3.3$ k Ω $T_j = 125^\circ\text{C}$ | ALL | MIN. 0.2 | V |
| I_H (2) | $I_T = 500$ mA | | MAX. 80 | mA |
| I_L | $I_G = 1.2$ I_{GT} | I - III - IV | MAX. 70 160 | mA |
| | | II | | |
| dV/dt (2) | $V_D = 67\%$ V_{DRM} gate open | $T_j = 125^\circ\text{C}$ | MIN. 500 | $\text{V}/\mu\text{s}$ |
| (dV/dt) _c (2) | (di/dt) _c = 20 A/ms | $T_j = 125^\circ\text{C}$ | MIN. 10 | $\text{V}/\mu\text{s}$ |

Table 5: Static Characteristics

| Symbol | Test Conditions | | | Value | Unit |
|------------------------|---------------------|---------------------------|---------------------------|--------------|---------------|
| V_T (2) | $I_{TM} = 60$ A | $t_p = 380$ μs | $T_j = 25^\circ\text{C}$ | MAX. 1.55 | V |
| V_{T0} (2) | Threshold voltage | | $T_j = 125^\circ\text{C}$ | MAX. 0.85 | V |
| R_d (2) | Dynamic resistance | | $T_j = 125^\circ\text{C}$ | MAX. 10 | m Ω |
| I_{DRM} I_{RRM} | $V_{DRM} = V_{RRM}$ | | $T_j = 25^\circ\text{C}$ | MAX. 5 | μA |
| | | | $T_j = 125^\circ\text{C}$ | | 5 |

Note 1: minimum I_{GT} is guaranteed at 5% of I_{GT} max.

Note 2: for both polarities of A2 referenced to A1.

Table 6: Thermal resistance

| Symbol | Parameter | | Value | Unit |
|---------------|-----------------------|-------------------------|-------|-----------------------------|
| $R_{th(j-c)}$ | Junction to case (AC) | RD91 (Insulated) / TOP3 | 0.9 | $^{\circ}\text{C}/\text{W}$ |
| | | TOP3 Insulated | 0.6 | |
| $R_{th(j-a)}$ | Junction to ambient | TOP3 / TOP3 Insulated | 50 | $^{\circ}\text{C}/\text{W}$ |

S = Copper surface under tab.

Figure 1: Maximum power dissipation versus RMS on-state current (full cycle)

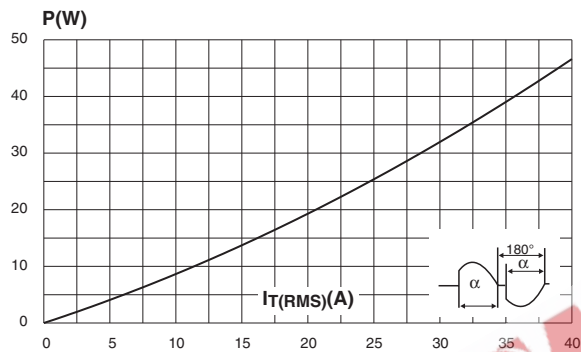

Figure 2: RMS on-state current versus case temperature (full cycle)

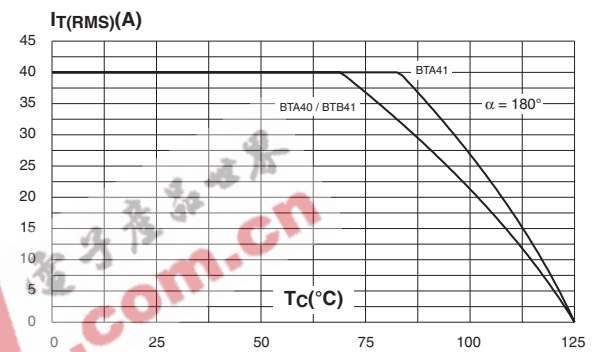

Figure 3: Relative variation of thermal impedance versus pulse duration

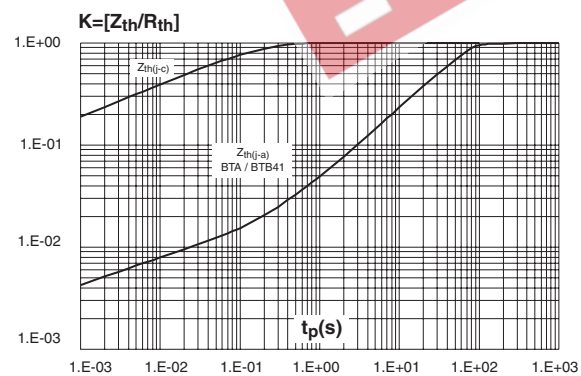

Figure 4: On-state characteristics (maximum values)

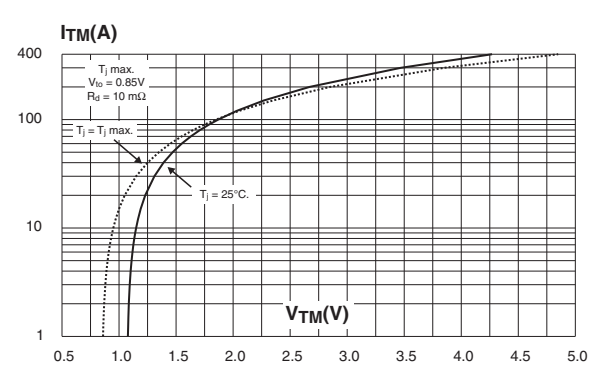

Figure 5: Surge peak on-state current versus number of cycles

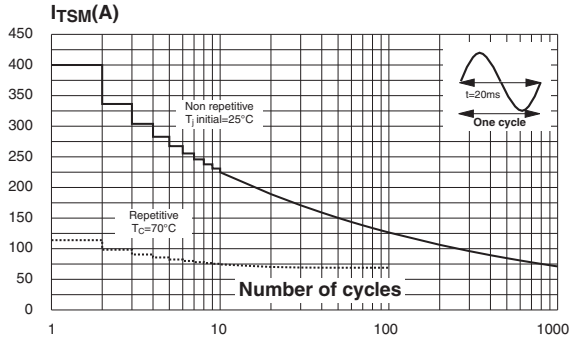

Figure 6: Non-repetitive surge peak on-state current for a sinusoidal pulse with width $t_p < 10$ ms and corresponding value of I^2t

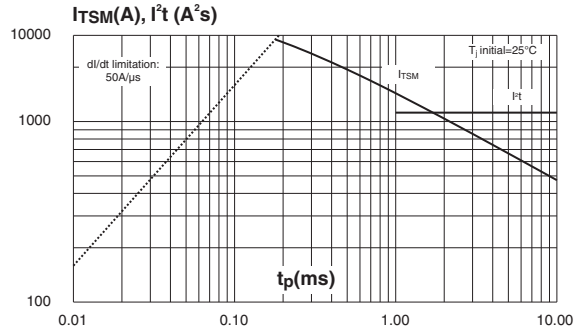

Figure 7: Relative variation of gate trigger current, holding current and latching current versus junction temperature (typical values)

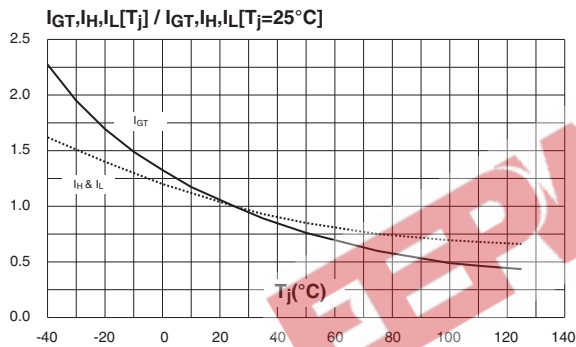

Figure 8: Relative variation of critical rate of decrease of main current versus $(dV/dt)_c$ (typical values)

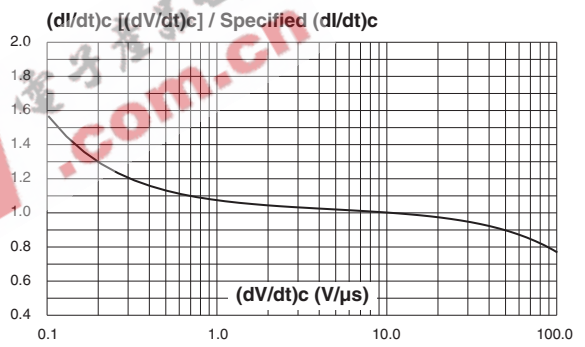

Figure 9: Relative variation of critical rate of decrease of main current versus $(dV/dt)_c$

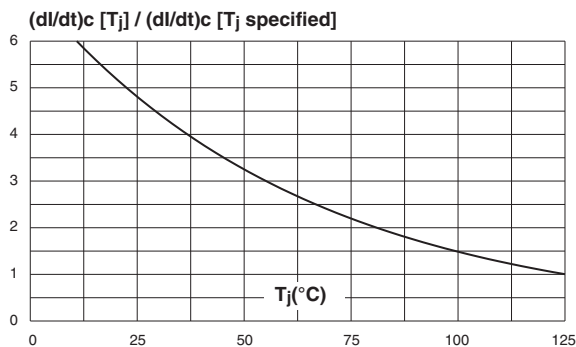

Figure 10: Ordering Information Scheme

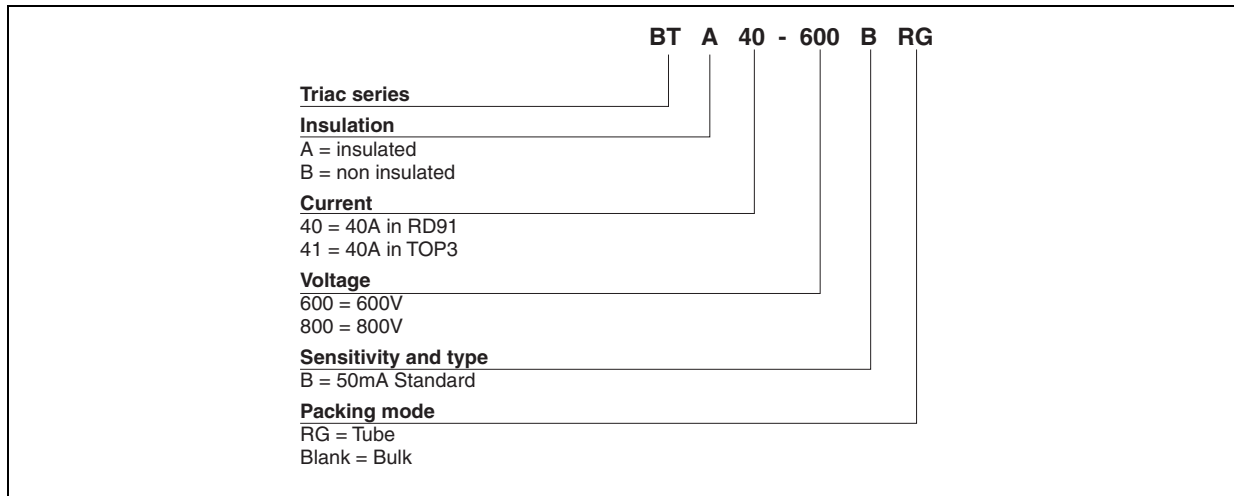
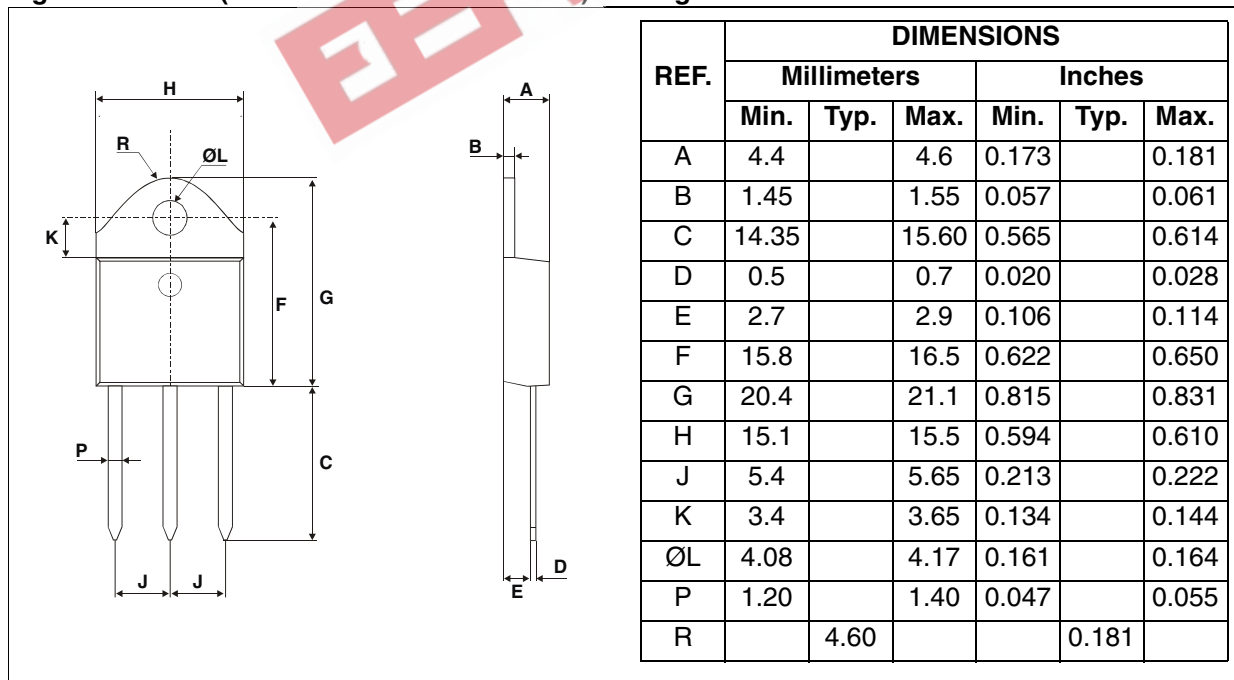

Table 7: Product Selector

| Part Numbers | Voltage (xxx) | | Sensitivity | Type | Package |
|--------------|---------------|-------|-------------|----------|-----------|
| | 600 V | 800 V | | | |
| BTA40-xxxB | X | X | 50 mA | Standard | RD91 |
| BTA41-xxxBRG | X | X | 50 mA | Standard | TOP3 Ins. |
| BTB41-xxxBRG | X | X | 50 mA | Standard | TOP3 |

BTB: non insulated TOP3 package

Figure 11: TOP3 (Insulated and non insulated) Package Mechanical Data



BTA40, BTA41 and BTB41 Series

Figure 12: RD91 Package Mechanical Data

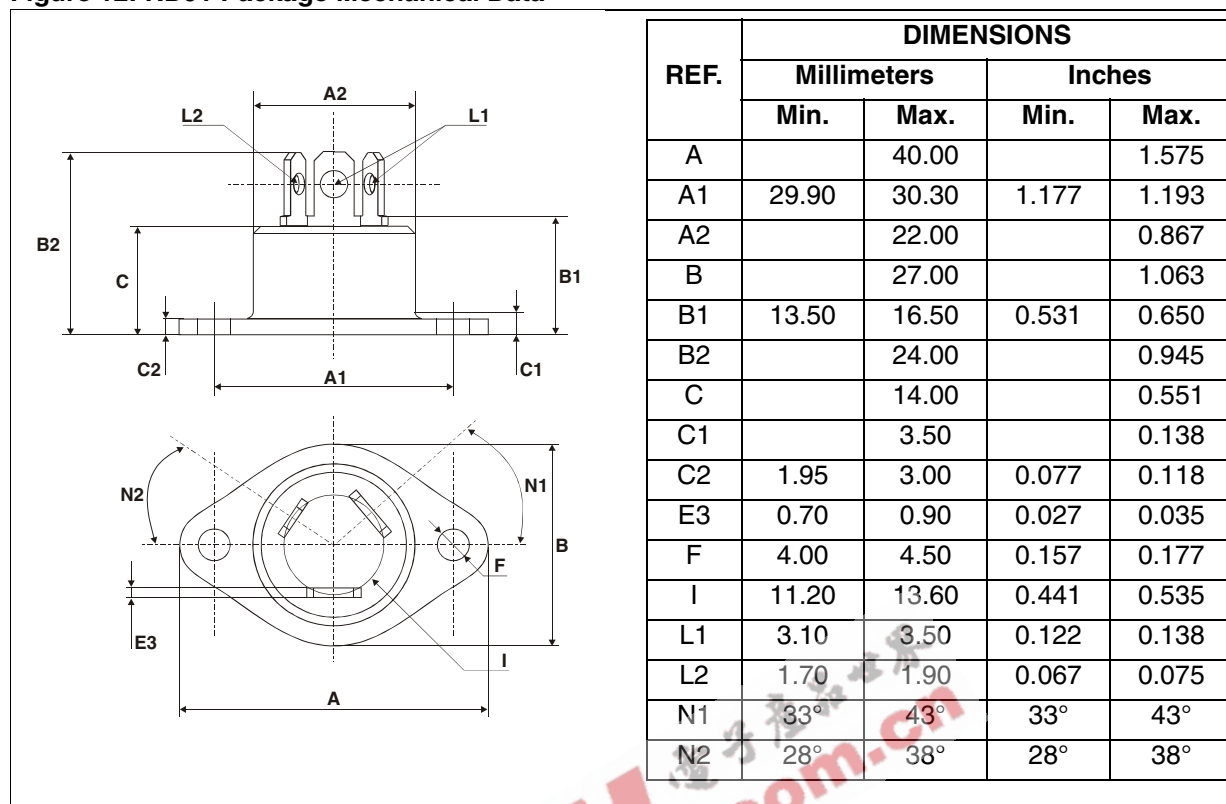

In order to meet environmental requirements, ST offers these devices in ECOPACK® packages. These packages have a Lead-free second level interconnect. The category of second level interconnect is marked on the package and on the inner box label, in compliance with JEDEC Standard JESD97. The maximum ratings related to soldering conditions are also marked on the inner box label. ECOPACK is an ST trademark. ECOPACK specifications are available at: www.st.com.

Table 8: Ordering Information

| Ordering type | Marking | Package | Weight | Base qty | Delivery mode |
|---------------|-----------|-----------|--------|----------|---------------|
| BTA40-xxxB | BTA40xxxB | RD91 | 20 g | 25 | Bulk |
| BTA41-xxxBRG | BTA41xxxB | TOP3 Ins. | 4.5 g | 30 | Tube |
| BTB41-xxxBRG | BTB41xxxB | TOP3 | 4.5 g | 30 | Tube |

Note: xxx = voltage

Table 9: Revision History

| Date | Revision | Description of Changes |
|-------------|----------|---|
| Sep-2003 | 5 | Last update. |
| 25-Mar-2005 | 6 | TOP3 delivery mode changed from bulk to tube. |
| 14-Oct-2005 | 7 | T _c values for I _T changed in Table 3. ECOPACK statement added. |



Information furnished is believed to be accurate and reliable. However, STMicroelectronics assumes no responsibility for the consequences of use of such information nor for any infringement of patents or other rights of third parties which may result from its use. No license is granted by implication or otherwise under any patent or patent rights of STMicroelectronics. Specifications mentioned in this publication are subject to change without notice. This publication supersedes and replaces all information previously supplied. STMicroelectronics products are not authorized for use as critical components in life support devices or systems without express written approval of STMicroelectronics.

The ST logo is a registered trademark of STMicroelectronics.
All other names are the property of their respective owners

© 2005 STMicroelectronics - All rights reserved

STMicroelectronics group of companies

Australia - Belgium - Brazil - Canada - China - Czech Republic - Finland - France - Germany - Hong Kong - India - Israel - Italy - Japan - Malaysia - Malta - Morocco - Singapore - Spain - Sweden - Switzerland - United Kingdom - United States of America
www.st.com