

Dolby* B-C Type Noise Reduction System

Description

The CXA1560 series is a bipolar IC incorporating stereo Dolby B-C type noise reduction (NR) system.

Five kinds of device are provided due to the combination of three line output levels and two packages for various applications.

A reduction in the number of external parts and small package have been achieved due to the fact that the spectral skewing circuits are all on-chip.

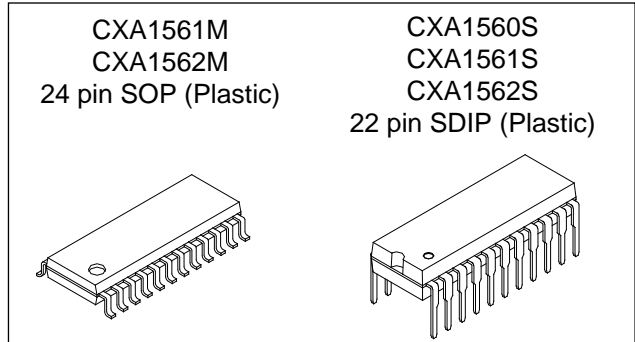

Features

- Few external parts
- Spectral skewing circuit are on-chip
- NR ON/OFF, REC/PB, MPX filter ON/OFF switches
- Small package (24-pin SOP, 22-pin SDIP)
- Low current consumption 13mA Typ.
(power supply $\pm 6V$)

Structure

Bipolar silicon monolithic IC

Absolute Maximum Ratings (Ta = 25°C)

• Supply voltage	$V_{CC} - V_{EE}$	17	V
• Operating temperature	T_{opr}	-40 to +85	°C
• Storage temperature	T_{stg}	-65 to +150	°C
• Allowable power dissipation	P_D	600 (SOP)	mW
		1200 (SDIP)	mW

* This IC is available only to the licensees of Dolby Laboratories Licensing Corporation from whom licensing and applications information may be obtained.

* "Dolby" and the double D symbols are trademarks of Dolby Laboratories Licensing Corporation.

Sony reserves the right to change products and specifications without prior notice. This information does not convey any license by any implication or otherwise under any patents or other right. Application circuits shown, if any, are typical examples illustrating the operation of the devices. Sony cannot assume responsibility for any problems arising out of the use of these circuits.

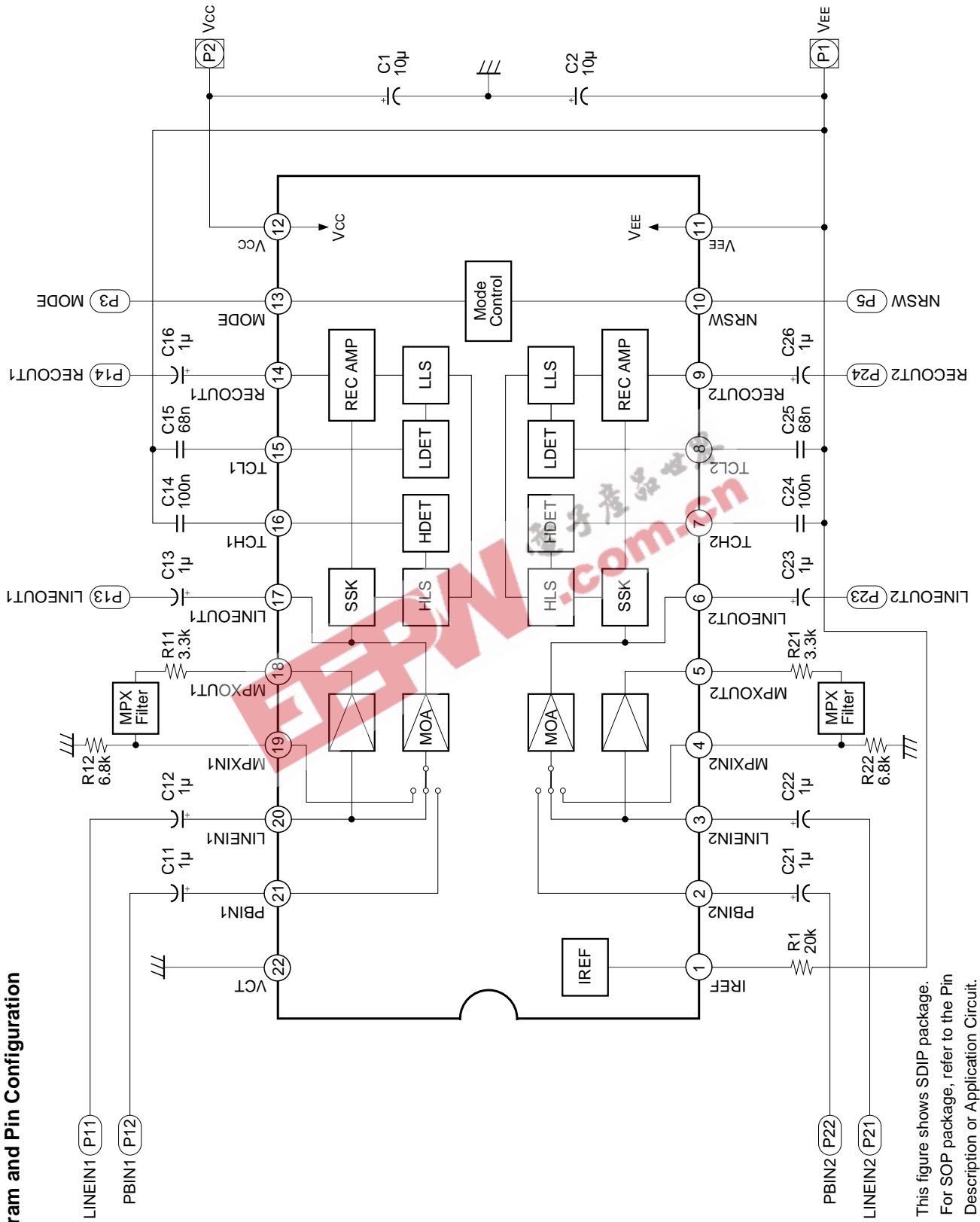

Block Diagram and Pin Configuration

Note) This figure shows SDIP package. For SOP package, refer to the Pin Description or Application Circuit.

Pin Description and Equivalent Circuit

Pin No.		Symbol	Z: Imp	VDC (V)	Equivalent circuit	Description
SOP	SDIP					
1	1	IREF	0	$V_{EE} + 1.25V$		Reference current pin for setting internal filter cut-off frequency
2, 23	2, 21	PB IN	40K	VCT		Playback input pin Reference level = -30dBm
4, 21	4, 19	MPX IN				Buffer amplifier input pin to drive multiplex filter Reference level = -19dBm
3, 22	3, 20	LINE IN	62K	VCT		Recording input pin Reference level = -25dBm
5, 20	5, 18	MPX OUT	0	VCT		Buffer amplifier output pin to drive multiplex filter Reference level = -15dBm

Pin No.		Symbol	Z: Imp	VDC (V)	Equivalent circuit	Description
SOP	SDIP					
6, 19	6, 17	LINE OUT	0	VCT		Line output pin
7, 15	7, 16	TCH	—	$V_{EE} + 0.4V$		Time constant connecting pin for HLS detector
8, 17	8, 15	TCL	—	$V_{EE} + 0.4V$		Time constant connecting pin for LLS detector
9, 16	9, 14	REC OUT	0	VCT		Recording output pin Reference level = -6dBm

Pin No.		Symbol	Z: Imp	VDC (V)	Equivalent circuit	Description
SOP	SDIP					
10	10	NRSW	—	—		NR control pin H: C type M: B type L: NR OFF
11	11	V _{EE}		V _{EE}		Dual power supply: V _{EE} Single power supply: GND pin
14	12	V _{CC}		V _{CC}		V _{CC}
15	13	MODE	—	—		MODE control pin H: REC (Filter ON) M: REC (Filter OFF) L: PB
24	22	VCT	0	VCT		Dual power supply: GND Single power supply: V _{CC} /2

Electrical Characteristics

Ta = 25°C, Dolby level: -6dBm (= 388mVrms) at REC OUT,
 Vcc = 15V (CXA1560), Vcc = 12V (CXA1561), Vcc = 9V (CXA1562)

Characteristics	Symbol	Measurement conditions*				Min.	Typ.	Max.	Unit
		R/P	NR	f (Hz)	Other conditions				
Operating voltage CXA1560 CXA1561 CXA1562	Vopr	—	—	—		11.5 8.5 7.2	— — —	16.0 16.0 16.0	V V V
Current consumption CXA1560 CXA1561 CXA1562	Icc	REC	OFF	—	No Signal	8.0 8.0 8.0	13.2 13.0 12.8	18.0 18.0 18.0	mA mA mA
LINE OUT level CXA1560 CXA1561 CXA1562	Vlout	REC	OFF	1k		-1.0 -4.0 -7.0	0.0 -3.0 -6.0	1.0 -2.0 -5.0	dBm dBm dBm
LINE IN level	Vlin	REC	OFF	1k		-27	-25	-23	dBm
PB IN level	Vpin	PB	OFF	1k		-32	-30	-28	dBm
MPX amplifier gain	Gmpx	MPX	OFF	1k		9.0	10.0	11.0	dB
Encode characteristics									
B type boost									
(1)	B-R-1	REC	B	500	-25dB	1.4	2.9	4.4	dB
(2)	B-R-2	REC	B	5k	-25dB	3.9	5.4	6.9	dB
(3)	B-R-3	REC	B	10k	-40dB	9.7	10.4	11.4	dB
(4)	B-R-4	REC	B	10k	0dB	-1.1	0.4	1.9	dB
C type boost									
(1)	C-R-1	REC	C	500	-60dB	14.2	16.2	18.2	dB
(2)	C-R-2	REC	C	500	-25dB	7.2	9.2	11.2	dB
(3)	C-R-3	REC	C	2k	-60dB	18.7	20.7	22.7	dB
(4)	C-R-4	REC	C	2k	-25dB	5.4	7.4	9.4	dB
(5)	C-R-5	REC	C	5k	-25dB	3.5	5.5	7.5	dB
(6)	C-R-6	REC	C	10k	0dB	-5.5	-3.5	-1.5	dB

Characteristics	Symbol	Measurement conditions*				Min.	Typ.	Max.	Unit
		R/P	NR	f (Hz)	Other conditions				
Signal handling CXA1560 CXA1561 CXA1562	Vomax	REC	OFF	1k	THD = 1%	13.5 13.5 13.5	16.0 16.2 16.0	— — —	dB dB dB
Total harmonic distortion									
1) NR OFF CXA1560 CXA1561 CXA1562	THD (OFF)	REC	OFF	1k	+10dB	— — —	0.03 0.02 0.02	0.1 0.1 0.1	% % %
2) B CXA1560 CXA1561 CXA1562	THD (B)	REC	B	1k	+10dB	— — —	0.03 0.03 0.04	0.1 0.1 0.1	% % %
3) C CXA1560 CXA1561 CXA1562	THD (C)	REC	C	1k	+10dB	— — —	0.04 0.04 0.05	0.2 0.2 0.2	% % %
S/N	SN (CCIR)	REC	C	—	Rg = 5Ω (CCIR/ARM)	60	64	—	dB
REC-PB PB-REC REC ch to ch	CT-1 CT-2 CT-3	PB REC REC	OFF OFF OFF	1k 1k 1k	0dB 0dB 0dB	— — —	-80 -87 -73	-70 -70 -65	dB dB dB
REC OUT offset Voltage (OFF-C type)	Voff	REC	OFF ↓ C	—		-100	0	100	mV

* 0dB means the level which provides the Dolby level to recording output when NR is off.

Electrical Characteristics Measurement Circuit

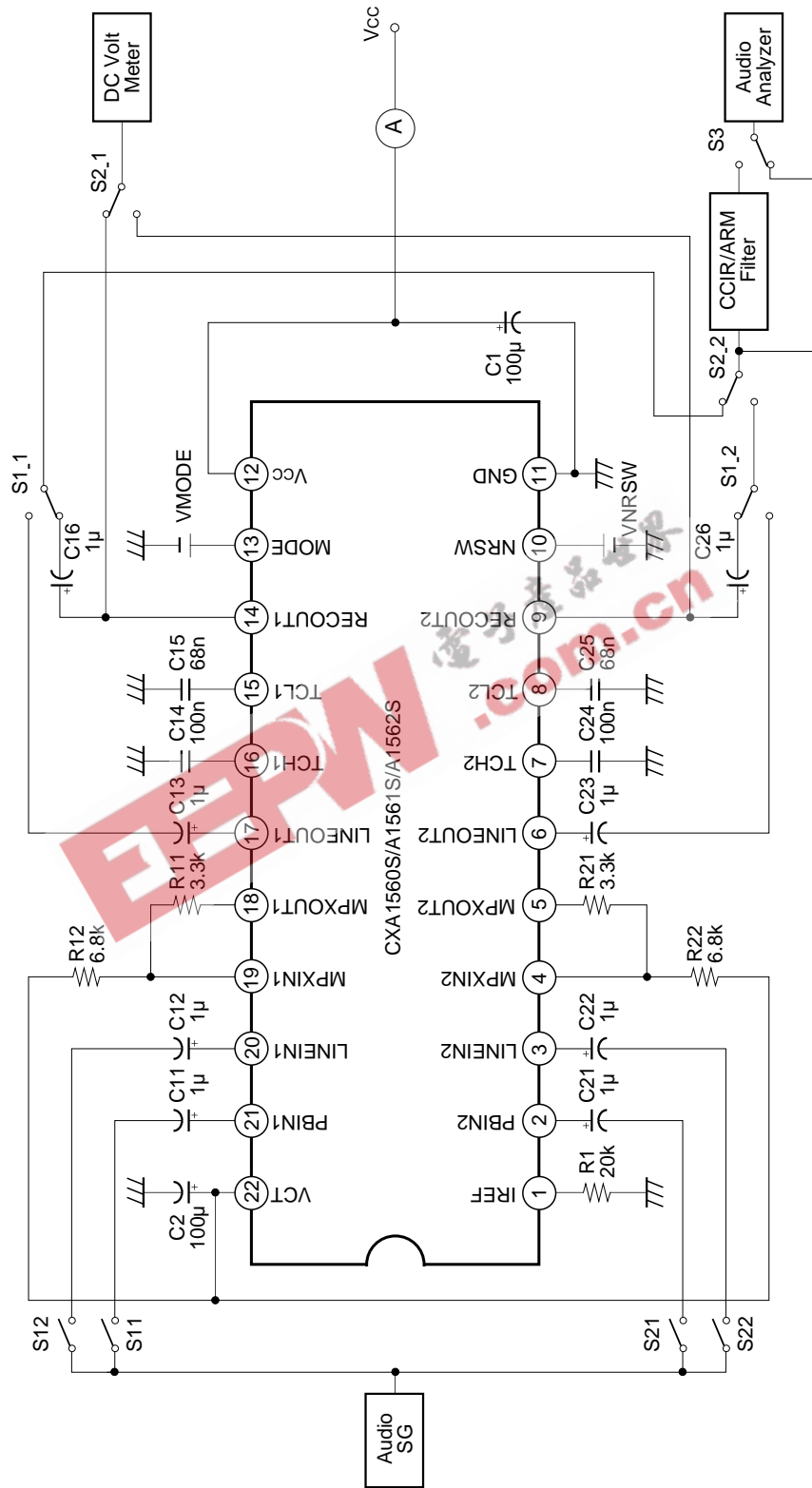

Application Circuit
Switchable Processor with Dual Power Supply (CXA1560S/1561S/1562S)

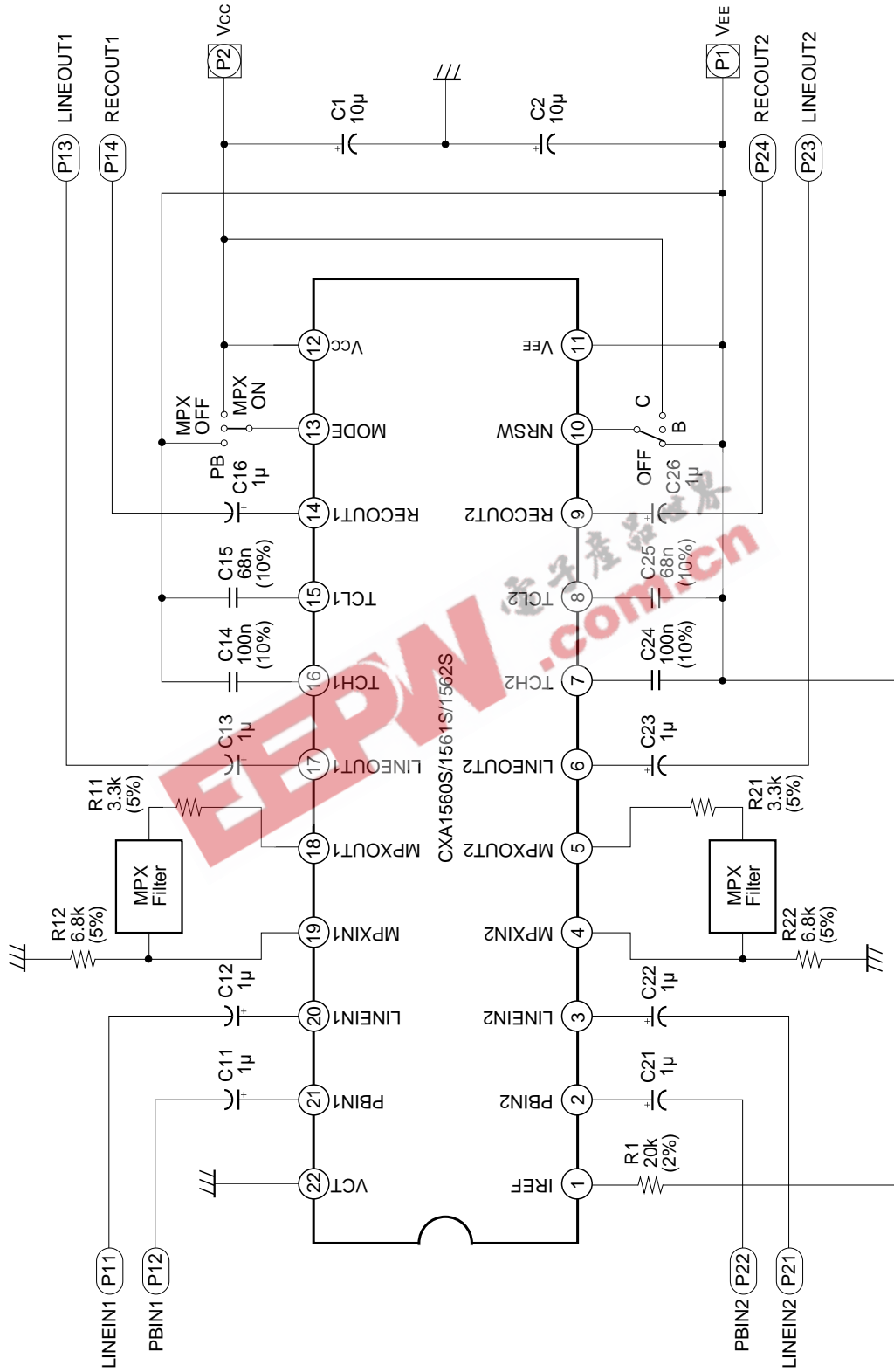

Note) Resistor and capacitor tolerances are $\pm 10\%$ and $\pm 20\%$ respectively, unless otherwise specified.

Application circuits shown are typical examples illustrating the operation of the devices. Sony cannot assume responsibility for any problems arising out of the use of these circuits or for any infringement of third party patent and other right due to same.

Switchable Processor with Dual Power Supply (CXA1561M/1562M)

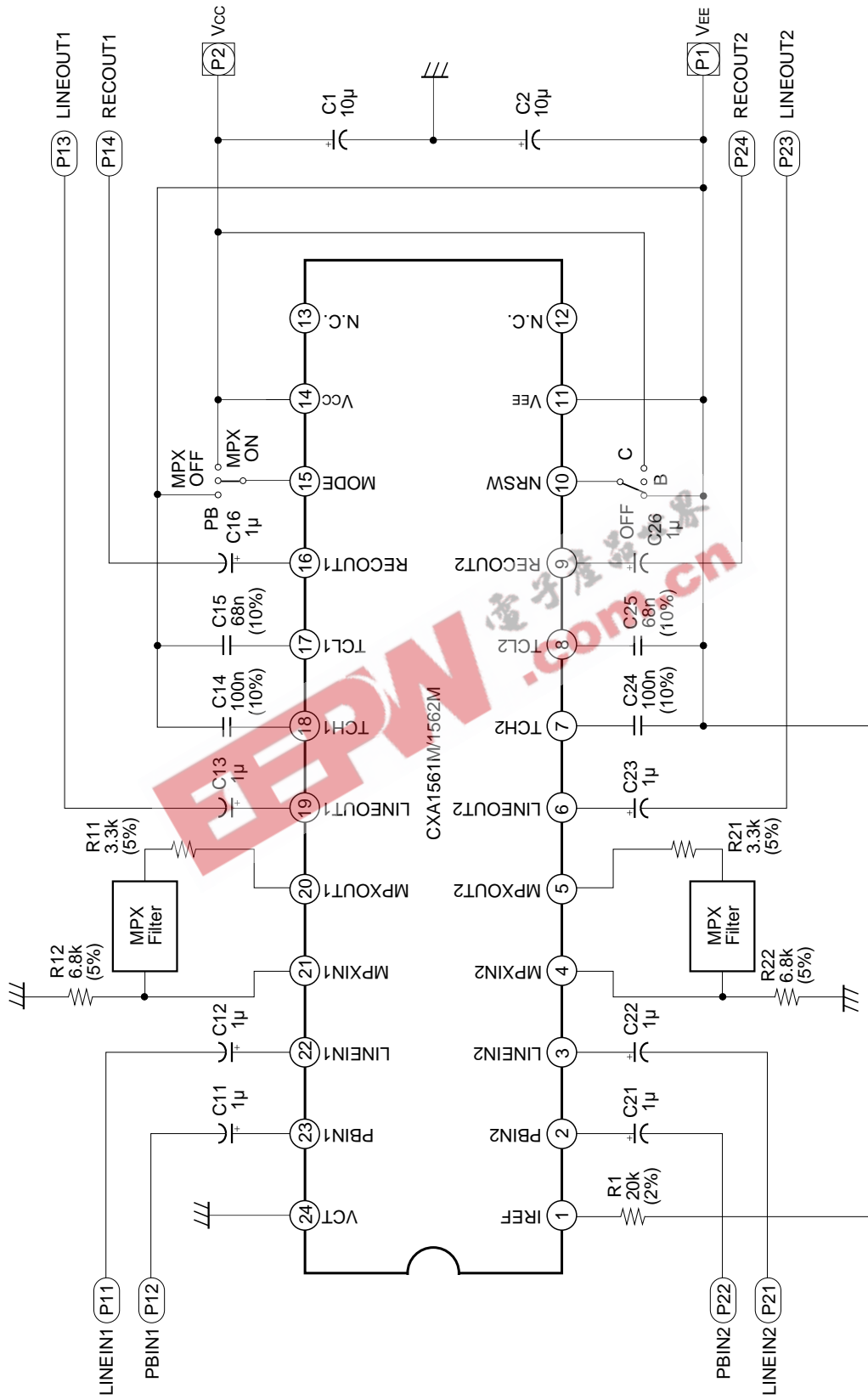

Note) Resistor and capacitor tolerances are $\pm 10\%$ and $\pm 20\%$ respectively, unless otherwise specified.

Application circuits shown are typical examples illustrating the operation of the devices. Sony cannot assume responsibility for any problems arising out of the use of these circuits or for any infringement of third party patent and other right due to same.

Switchable Processor with Single Power Supply (CXA1560S/1561S/1562S)

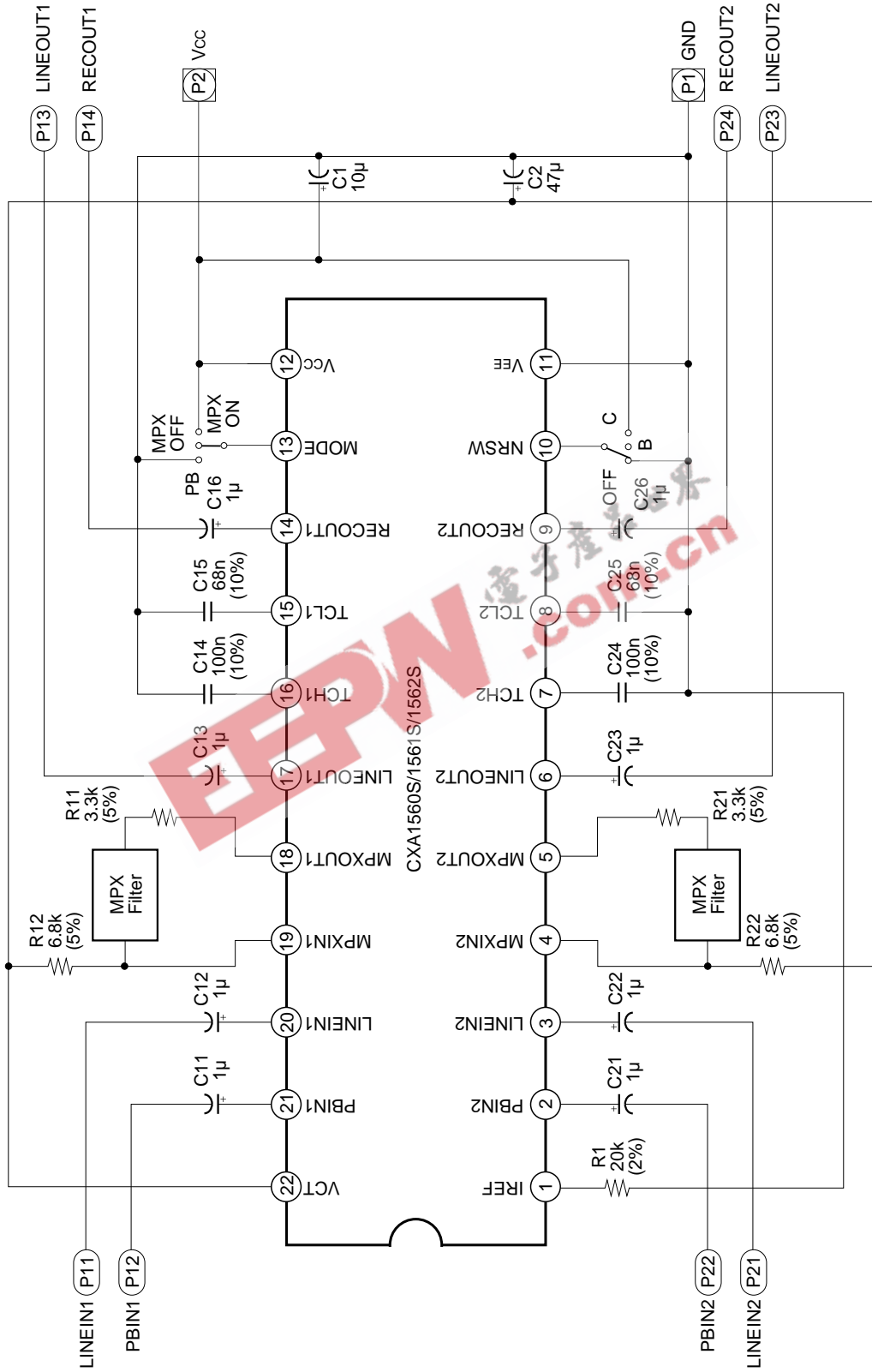

Note) Resistor and capacitor tolerances are ±10% and ±20% respectively, unless otherwise specified.

Application circuits shown are typical examples illustrating the operation of the devices. Sony cannot assume responsibility for any problems arising out of the use of these circuits or for any infringement of third party patent and other right due to same.

Switchable Processor with Single Power Supply (CXA1561M/1562M)

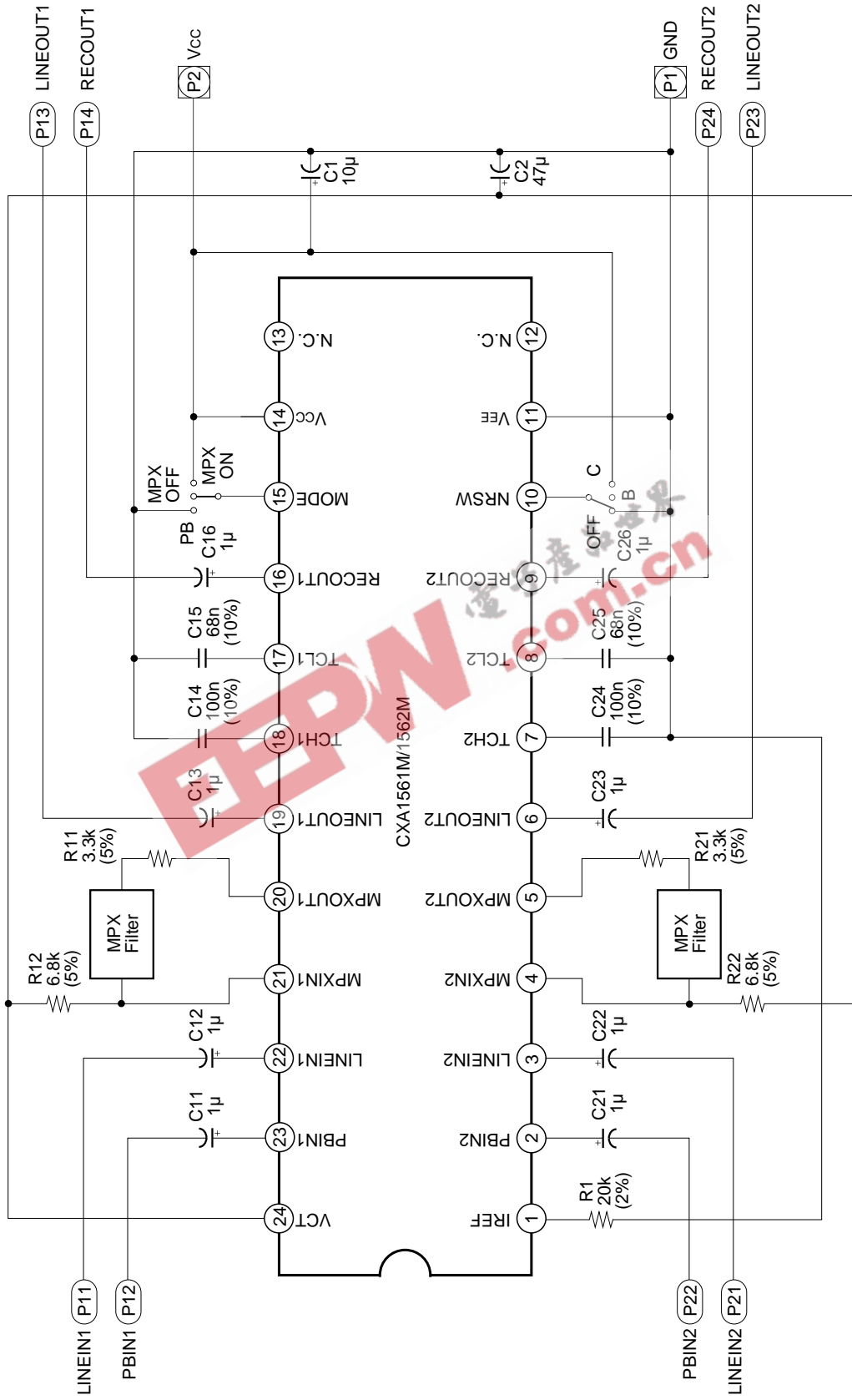

Note) Resistor and capacitor tolerances are ±10% and ±20% respectively, unless otherwise specified.

Application circuits shown are typical examples illustrating the operation of the devices. Sony cannot assume responsibility for any problems arising out of the use of these circuits or for any infringement of third party patent and other right due to same.

Application Note

The CXA1560 series is a stereo Dolby B-C type NR IC like the CXA1330 series.
Built-in spectral skewing circuit allows smaller package.

1) Power Supply

The CXA1560 series is designed to operate on either single or dual power supply.
For dual power supply, connect VCT to GND, and V_{EE} to the negative power supply.
For single power supply, connect V_{EE} to GND. $V_{cc}/2$, generated from the internal circuit, is output to VCT.
Connect a by-pass capacitor between this pin and GND.
The operating voltage range is ± 3.5 to $\pm 8.0V$ (7.0 to 16V), which satisfies the signal handling of 12dB specified by the Dolby Laboratories.

2) Operation Mode Control

The CXA1560 series has built-in electronic switches. The operations are controlled by the DC voltages of NRSW and MODE control pins. Table 1 shows the switching truth tables.
For single power supply, VH, VM, and VL correspond to V_{cc} , $V_{cc}/2$ and GND, respectively.
For dual power supply, VH, VM and VL correspond to V_{cc} , GND and V_{EE} , respectively.
Refer to "threshold" on the characteristics graph for the thresholds of the control voltages. NRSW and MODE control pins are connected to VCT via a 50k Ω resistor, so when the pin is open, VM condition results.

	VH	VM	VL
NRSW	C type	B type	NR OFF
MODE	MPX ON REC (Encode)	MPX OFF REC (Encode)	PB (Decode)

Table 1

3) Reference level

The CXA1560 series Dolby level is $-6dBm$ (388mVrms), and is measured at the recording output pin (REC OUT) in the NR OFF mode. The reference level of the recording input pin (LINE IN), playback input pin (PB IN) and line output pin (LINE OUT) are defined as the levels which provide Dolby level at the recording output pin in NR OFF mode.

4) MPX Filter

The CXA1560 series provides an MPX (FM multiplex) filter ON/OFF function.
Connect the MPX filter between MPX IN and MPX OUT. In MPX ON mode, the line input signal is fed to the NR processor via the MPX buffer amplifier and MPX filter. In MPX OFF mode, the signal bypasses the buffer amplifier and filter, and is fed directly to the NR processor. The MPX buffer amplifier gain is 10dB. The gain from LINE IN to LINE OUT is 19dB, and from MPX IN to LINE OUT it is 13dB, for a deviation of 6dB. This means that if a filter with insertion loss of 4dB is used, there is no fluctuation between MPX ON and MPX OFF.

Example of Representative Characteristics

Quiescent current consumption vs. Supply voltage

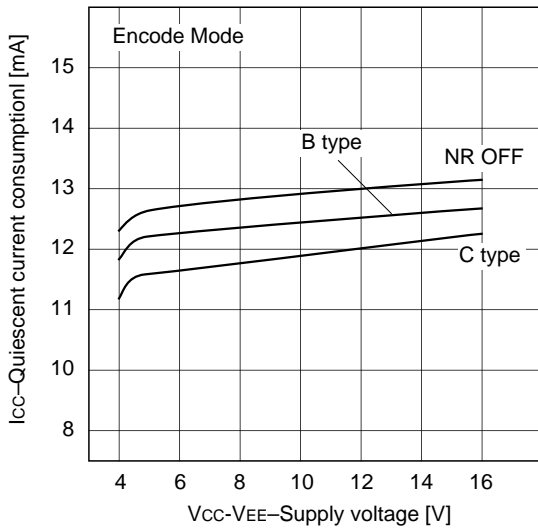

Current consumption vs. Input level

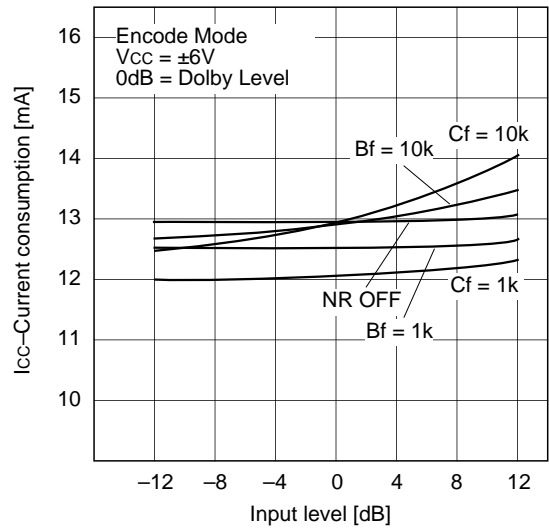

B type encode characteristics

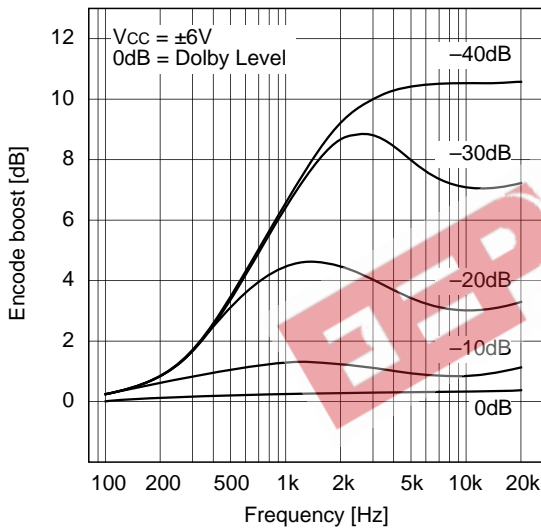

C type encode characteristics

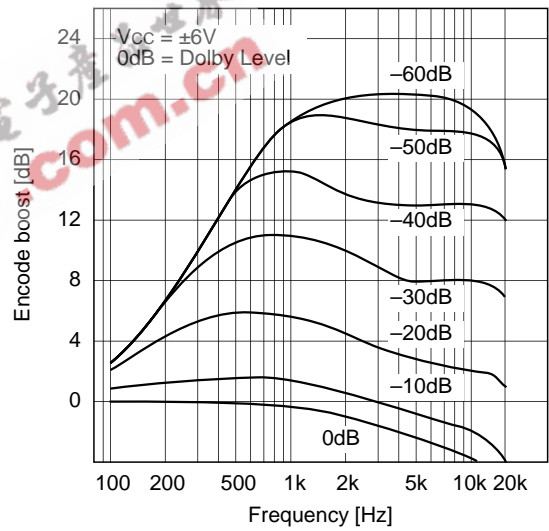

Signal handling

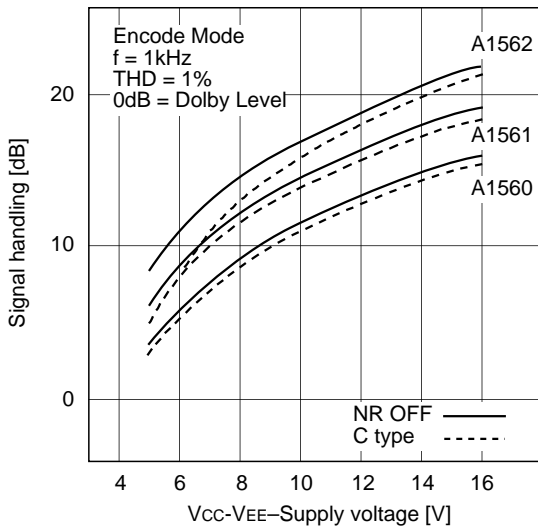

Load characteristics

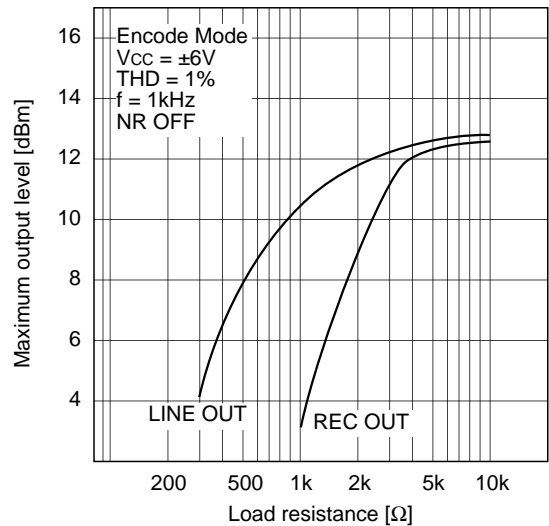

NR OFF total harmonic distortion-1 (CXA1561)

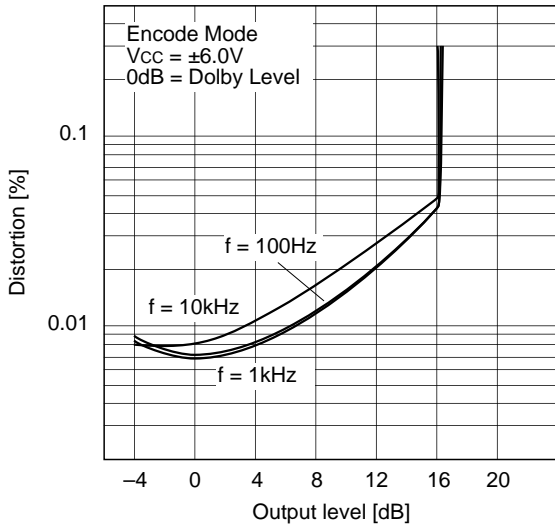

NR OFF total harmonic distortion-2 (CXA1560)

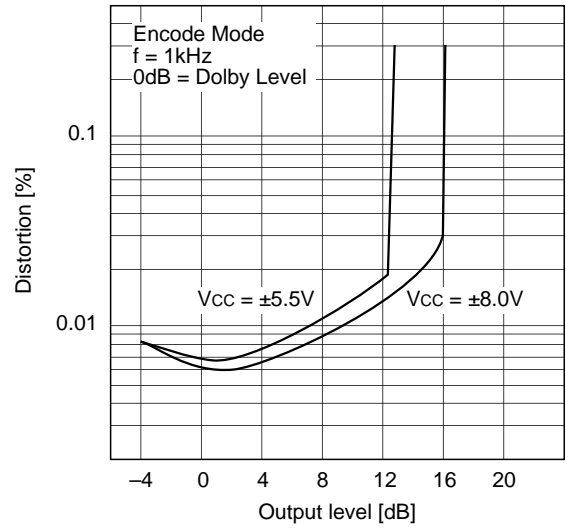

B type total harmonic distortion-1 (CXA1561)

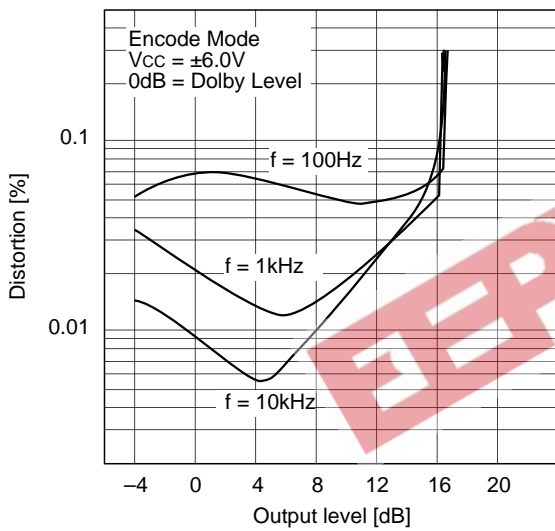

B type total harmonic distortion-2 (CXA1560)

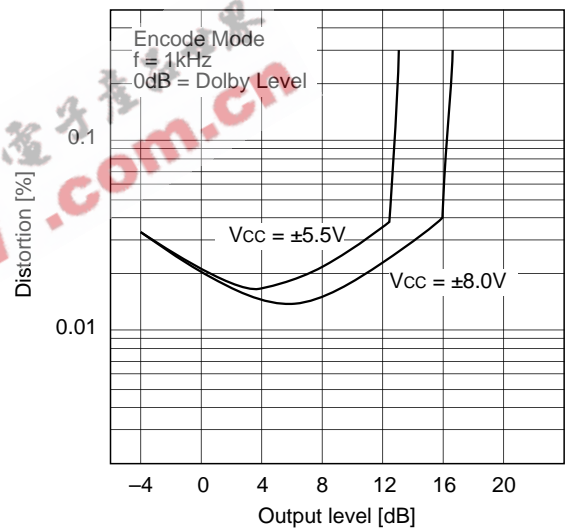

C type total harmonic distortion-1 (CXA1561)

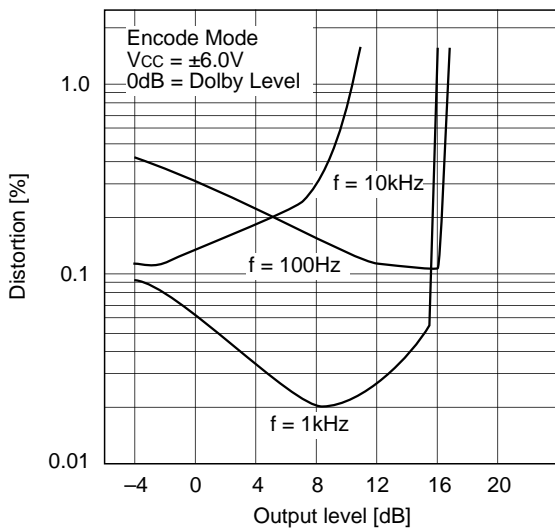

C type total harmonic distortion-2 (CXA1560)

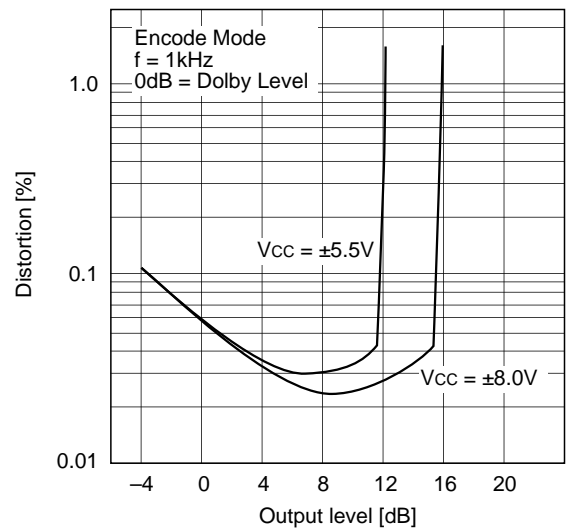

NR OFF total harmonic distortion-3 (CXA1561)

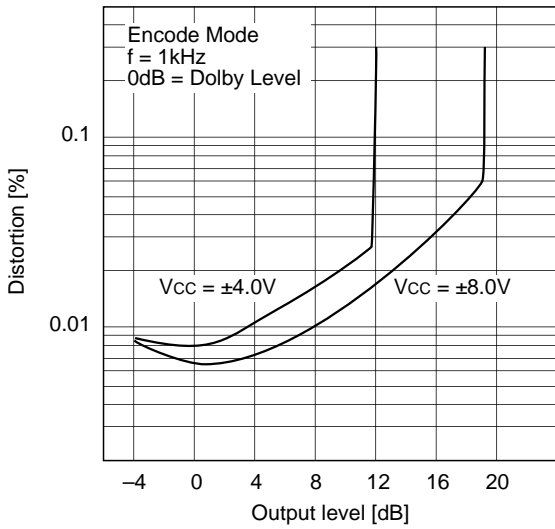

NR OFF total harmonic distortion-4 (CXA1562)

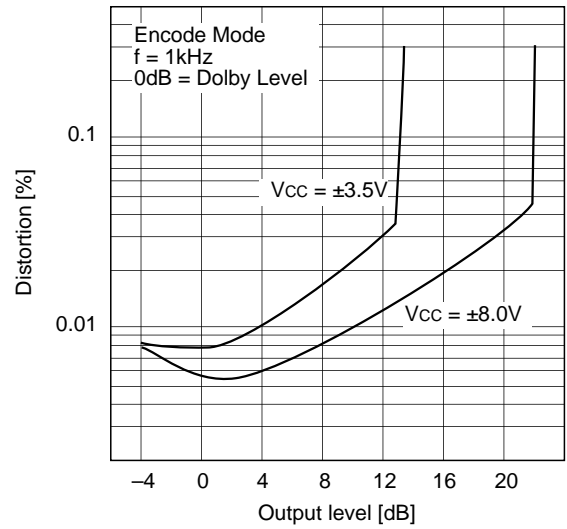

B type total harmonic distortion-3 (CXA1561)

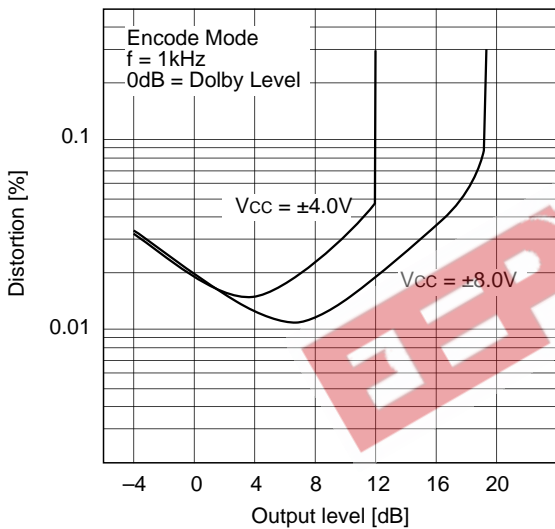

B type total harmonic distortion-4 (CXA1562)

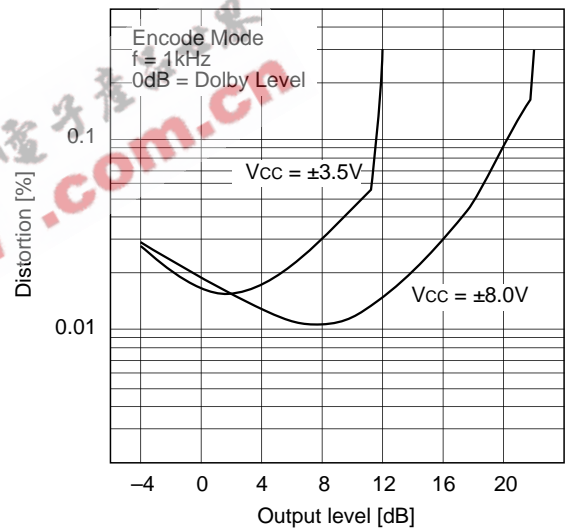

C type total harmonic distortion-3 (CXA1561)

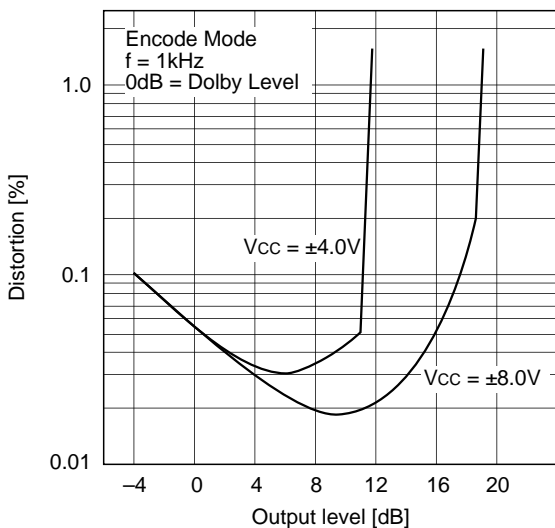

C type total harmonic distortion-4 (CXA1562)

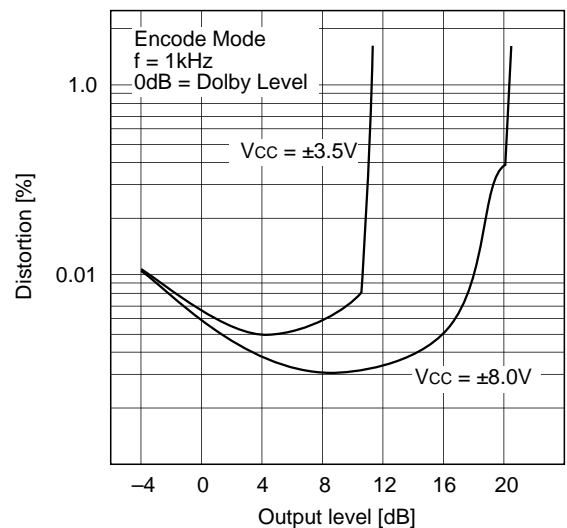

Cross talk

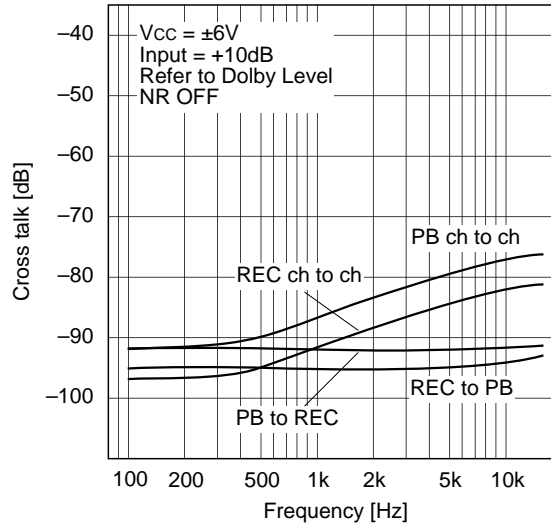

NR control threshold

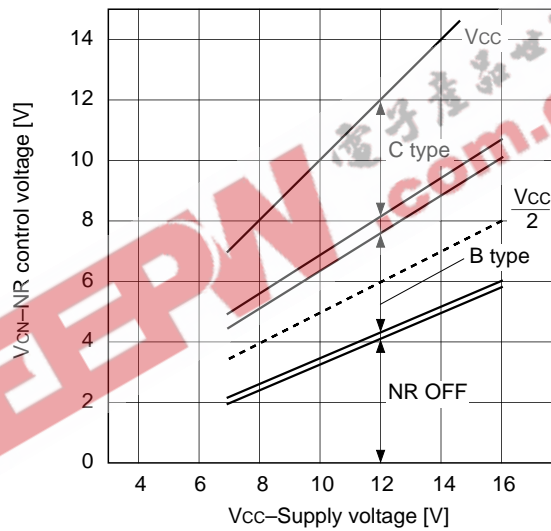

MODE control threshold

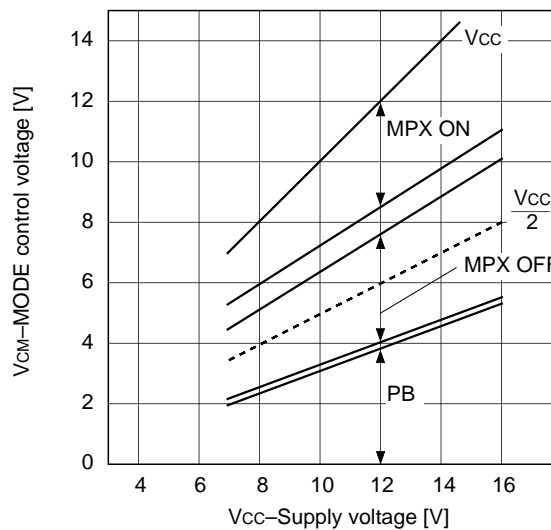

Package Outline Unit: mm

CXA1561M, CXA1562M

24PIN SOP (PLASTIC)

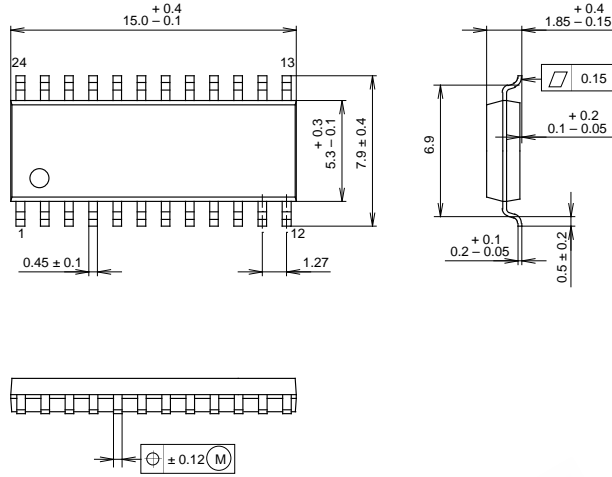

SONY CODE	SOP-24P-L01
EIAJ CODE	+SOP024-P-0300-A
JEDEC CODE	—

PACKAGE STRUCTURE

MOLDING COMPOUND	EPOXY/PHENOL RESIN
LEAD TREATMENT	SOLDER PLATING
LEAD MATERIAL	COPPER ALLOY / 42ALLOY
PACKAGE WEIGHT	0.3g

CXA1560S, CXA1561S, CXA1562S

22PIN SDIP (PLASTIC)

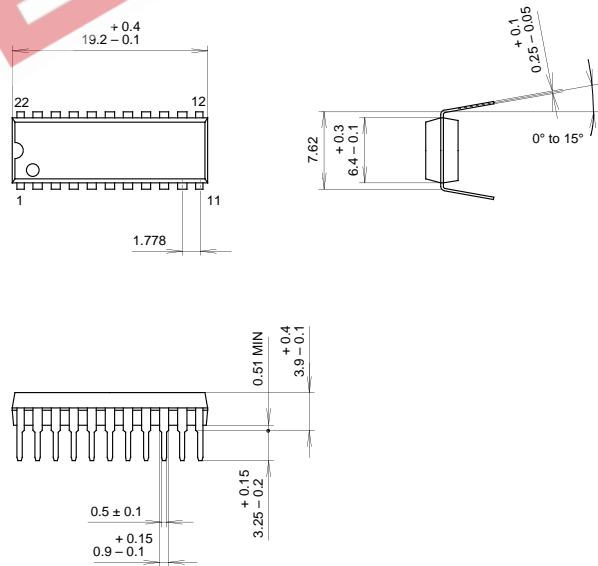

SONY CODE	SDIP-22P-01
EIAJ CODE	SDIP022-P-0300
JEDEC CODE	—

PACKAGE STRUCTURE

MOLDING COMPOUND	EPOXY RESIN
LEAD TREATMENT	SOLDER PLATING
LEAD MATERIAL	COPPER ALLOY
PACKAGE WEIGHT	0.95g