

# CMOS Quad Bilateral Switch

For Transmission or Multiplexing of Analog or Digital Signals

High-Voltage Types (20-Volt Rating)

■ CD4016B Series types are quad bilateral switches intended for the transmission or multiplexing of analog or digital signals. Each of the four independent bilateral switches has a single control signal input which simultaneously biases both the p and n device in a given switch on or off.

The CD4016 "B" Series types are supplied in 14-lead hermetic dual-in-line ceramic packages (D and F suffixes), 14-lead dual-in-line plastic packages (E suffix), and in chip form (H suffix).

### Features:

- 20-V digital or  $\pm 10$ -V peak-to-peak switching
- 280- $\Omega$  typical on-state resistance for 15-V operation
- Switch on-state resistance matched to within 10  $\Omega$  typ. over 15-V signal-input range
- High on/off output-voltage ratio: 65 dB typ. @  $f_{is} = 10$  kHz,  $R_L = 10$  k $\Omega$
- High degree of linearity: <0.5% distortion typ. @  $f_{is} = 1$  kHz,  $V_{is} = 5$  V<sub>p-p</sub>,  $V_{DD} - V_{SS} \geq 10$  V,  $R_L = 10$  k $\Omega$
- Extremely low off-state switch leakage resulting in very low offset current and high effective off-state resistance: 100 pA typ. @  $V_{DD} - V_{SS} = 18$  V,  $T_A = 25^\circ\text{C}$
- Extremely high control input impedance (control circuit isolated from signal circuit): 10<sup>12</sup>  $\Omega$  typ.
- Low crosstalk between switches: -50 dB typ. @  $f_{is} = 0.9$  MHz,  $R_L = 1$  k $\Omega$
- Matched control-input to signal-output capacitance: Reduces output signal transients
- Frequency response, switch on = 40 MHz (typ.)
- 100% tested for quiescent current at 20 V
- Maximum control input current of 1  $\mu\text{A}$  at 18 V over full package temperature range; 100 nA at 18 V at 25 $^\circ\text{C}$
- 5-V, 10-V, and 15-V parametric ratings

### Applications:

- Analog signal switching/multiplexing
  - Signal gating
  - Squelch control
  - Chopper
  - Modulator
  - Demodulator
  - Commutating switch
- Digital signal switching/multiplexing
- CMOS logic implementation
- Analog-to-digital & digital-to-analog conversion
- Digital control of frequency, impedance, phase, and analog-signal gain

# CD4016B Types

### Terminal Assignment

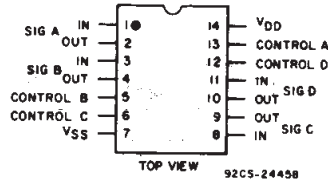

TOP VIEW 92CS-2445B

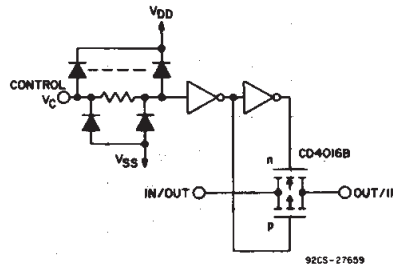

Schematic diagram - 1 of 4 identical sections.

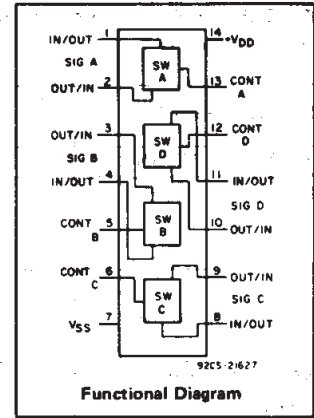

Functional Diagram 92CS-21627

### RECOMMENDED OPERATING CONDITIONS

For maximum reliability, nominal operating conditions should be selected so that operation is always within the following range:

CHARACTERISTIC	LIMITS		UNITS
	Min.	Max.	
Supply Voltage Range (For $T_A =$ Full Package Temperature Range)	3	18	V

### MAXIMUM RATINGS, Absolute-Maximum Values:

- DC SUPPLY-VOLTAGE RANGE, ( $V_{DD}$ ) Voltages referenced to  $V_{SS}$  Terminal: -0.5V to +20V
- INPUT VOLTAGE RANGE, ALL INPUTS: -0.5V to  $V_{DD} + 0.5$ V
- DC INPUT CURRENT, ANY ONE INPUT:  $\pm 10$  mA
- POWER DISSIPATION PER PACKAGE ( $P_D$ ):
  - For  $T_A = -55^\circ\text{C}$  to  $+100^\circ\text{C}$ : 500mW
  - For  $T_A = +100^\circ\text{C}$  to  $+125^\circ\text{C}$ : Derate Linearly at 12mW/ $^\circ\text{C}$  to 200mW
- DEVICE DISSIPATION PER OUTPUT TRANSISTOR
  - FOR  $T_A =$  FULL PACKAGE-TEMPERATURE RANGE (All Package Types): 100mW
- OPERATING-TEMPERATURE RANGE ( $T_A$ ): -55 $^\circ\text{C}$  to +125 $^\circ\text{C}$
- STORAGE TEMPERATURE RANGE ( $T_{stg}$ ): -65 $^\circ\text{C}$  to +150 $^\circ\text{C}$
- LEAD TEMPERATURE (DURING SOLDERING):
  - At distance 1/16  $\pm$  1/32 inch (1.59  $\pm$  0.79mm) from case for 10s max: +265 $^\circ\text{C}$

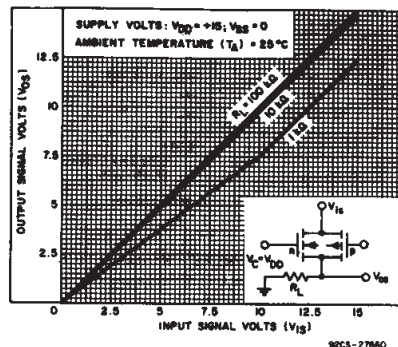

Fig. 1—Typ. on-state characteristics for 1 of 4 switches with  $V_{DD} = +15$  V,  $V_{SS} = 0$  V.

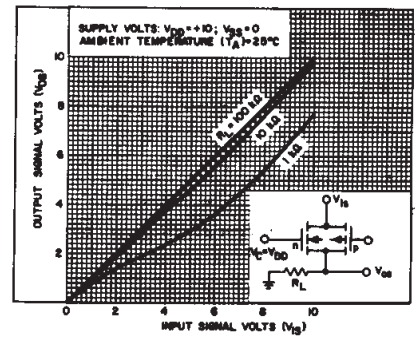

Fig. 2—Typ. on-state characteristics for 1 of 4 switches with  $V_{DD} = +10$  V,  $V_{SS} = 0$  V.

# CD4016B Types

## ELECTRICAL CHARACTERISTICS

CHARACTERISTIC	TEST CONDITIONS	LIMITS AT INDICATED TEMPERATURES (°C)							UNITS	
		V <sub>IN</sub> (V)	V <sub>DD</sub> (V)					+25		
				-55	-40	+85	+125	Typ.		Max.
Quiescent Device Current, I <sub>DD</sub>		0,5	5	0,25	0,25	7,5	7,5	0,01	0,25	μA
		0,10	10	0,5	0,5	15	15	0,01	0,5	
		0,15	15	1	1	30	30	0,01	1	
		0,20	20	5	5	150	150	0,02	5	
Signal Inputs (V <sub>is</sub> ) and Output (V <sub>os</sub> )										
On-State Resistance, r <sub>on</sub> Max.	V <sub>C</sub> = V <sub>DD</sub> R <sub>L</sub> = 10kΩ Returned to V <sub>DD</sub> -V <sub>SS</sub> 2	V <sub>is</sub> = V <sub>DD</sub> or V <sub>SS</sub>	10	600	610	840	960	-	660	Ω
			V <sub>is</sub> = 4.75 to 5.75 V	10	1870	1900	2380	2600	-	
		V <sub>is</sub> = V <sub>DD</sub> or V <sub>SS</sub>	15	360	370	520	600	-	400	
			V <sub>is</sub> = 7.25 to 7.75 V	15	775	790	1080	1230	-	
ΔOn-State Resistance Between Any 2 Switches, Δr <sub>on</sub>	R <sub>L</sub> = 10kΩ, V <sub>C</sub> = V <sub>DD</sub>		5	-	-	-	-	15	-	Ω
		10	-	-	-	-	-	10	-	
		15	-	-	-	-	-	5	-	
Total Harmonic Distortion, THD	V <sub>C</sub> = V <sub>DD</sub> = 5 V, V <sub>SS</sub> = -5 V, V <sub>is</sub> (p-p) = 5 V (Sine wave centered on 0 V) R <sub>L</sub> = 10 kΩ, f <sub>is</sub> = 1 kHz sine wave		-	-	-	-	-	0.4	-	%
-3dB Cutoff Frequency (Switch on)	V <sub>C</sub> = V <sub>DD</sub> = 5 V, V <sub>SS</sub> = -5 V, V <sub>is</sub> (p-p) = 5 V (Sine wave centered on 0 V) R <sub>L</sub> = 1 kΩ.		-	-	-	-	-	40	-	MHz
-50dB Feedthrough Frequency (Switch off)	V <sub>C</sub> = V <sub>SS</sub> = -5 V, V <sub>is</sub> (p-p) = 5 V (Sine wave centered on 0 V) R <sub>L</sub> = 1 kΩ.		-	-	-	-	-	1.25	-	MHz
Input/Output Leakage Current (Switch off) I <sub>is</sub> Max.	V <sub>C</sub> = 0 V V <sub>is</sub> = 18 V, V <sub>os</sub> = 0 V; V <sub>is</sub> = 0 V, V <sub>os</sub> = 18 V	18	±0.1	±0.1	±1	±1	10 <sup>-4</sup>	±0.1	μA	
-50 dB Crosstalk Frequency	V <sub>C</sub> (A) = V <sub>DD</sub> = +5 V, V <sub>C</sub> (B) = V <sub>SS</sub> = -5 V, V <sub>is</sub> (A) = 5 V p-p, 50 Ω source R <sub>L</sub> = 1 kΩ.		-	-	-	-	-	0.9	-	MHz
Propagation Delay (Signal Input to Signal Output) t <sub>pd</sub>	R <sub>L</sub> = 200 kΩ V <sub>C</sub> = V <sub>DD</sub> , V <sub>SS</sub> = GND, C <sub>L</sub> = 50 pF V <sub>is</sub> = Square Wave 0 to V <sub>DD</sub> t <sub>r</sub> , t <sub>f</sub> = 20 ns	5	-	-	-	-	40	100	ns	
		10	-	-	-	-	20	40		
		15	-	-	-	-	15	30		
Capacitance: Input, C <sub>is</sub> Output, C <sub>os</sub> Feedthrough, C <sub>ios</sub>	V <sub>DD</sub> = +5 V V <sub>C</sub> = V <sub>SS</sub> = -5 V		-	-	-	-	4	-	pF	
			-	-	-	-	4	-		
			-	-	-	-	0.2	-		

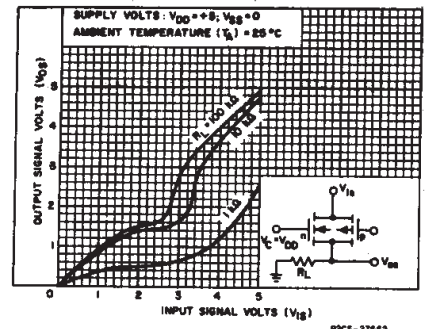

Fig. 3—Typ. on-state characteristics for 1 of 4 switches with V<sub>DD</sub> = +5 V, V<sub>SS</sub> = 0 V.

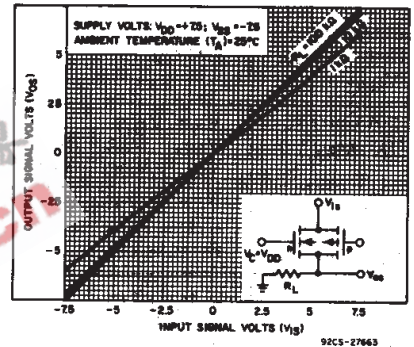

Fig. 4—Typ. on-state characteristics for 1 of 4 switches with V<sub>DD</sub> = +7.5 V, V<sub>SS</sub> = -7.5 V.

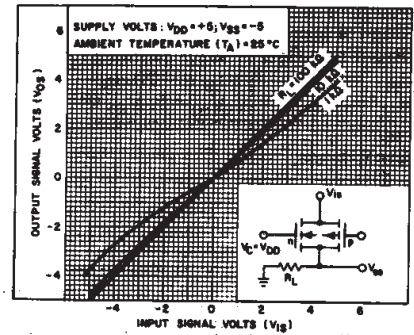

Fig. 5—Typ. on-state characteristics for 1 of 4 switches with V<sub>DD</sub> = +5 V, V<sub>SS</sub> = -5 V.

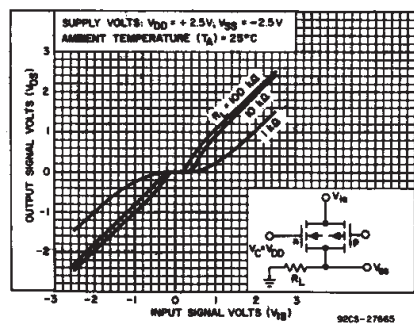

Fig. 6—Typ. on-state characteristics for 1 of 4 switches with V<sub>DD</sub> = +2.5 V, V<sub>SS</sub> = -2.5 V.

# CD4016B Types

## ELECTRICAL CHARACTERISTICS (cont'd)

CHARACTERISTIC	TEST CONDITIONS	LIMITS AT INDICATED TEMPERATURES (°C)						UNITS	
		V <sub>DD</sub> (V)					+25		
			-55	-40	+85	+125	Typ.		Max.
<b>Control (V<sub>C</sub>)</b>									
Control Input Low Voltage, V <sub>ILC</sub> (Max.)	$ I_{is}  < 10 \mu A$ $V_{is} = V_{SS}, V_{OS} = V_{DD}$ and $V_{is} = V_{DD}, V_{OS} = V_{SS}$	5, 10, 15	0.9	0.9	0.4	0.4	-	0.7	V
Control Input High Voltage, V <sub>IHC</sub>	See Fig. 10	5, 10, 15	3.5 (Min.) 7 (Min.) 11 (Min.)				-	-	V
Input Current, I <sub>IN</sub> (Max.)	$V_{is} \leq V_{DD}$ $V_{DD} - V_{SS} = 18 V$ $V_{CC} \leq V_{DD} - V_{SS}$	18	±0.1	±0.1	±1	±1	±10-5	±0.1	μA
Crosstalk (Control Input to Signal Output)	V <sub>C</sub> = 10 V (Sq. Wave) t <sub>r</sub> , t <sub>f</sub> = 20 ns R <sub>L</sub> = 10 kΩ	10	-	-	-	-	50	-	mV
Turn-On Propagation Delay	t <sub>r</sub> , t <sub>f</sub> = 20 ns C <sub>L</sub> = 50 pF R <sub>L</sub> = 1 kΩ	5	-	-	-	-	35	70	ns
		10	-	-	-	-	20	40	
		15	-	-	-	-	15	30	
Maximum Control Input Repetition Rate	V <sub>is</sub> = V <sub>DD</sub> , V <sub>SS</sub> = GND, R <sub>L</sub> = 1 kΩ to gnd, C <sub>L</sub> = 50 pF, V <sub>C</sub> = 10 V (Square wave centered on 5 V) t <sub>r</sub> , t <sub>f</sub> = 20 ns, V <sub>OS</sub> = ½ V <sub>OS</sub> @ 1 kHz	10	-	-	-	-	10	-	MHz
Input Capacitance, C <sub>IN</sub>			-	-	-	-	5	7.5	μF

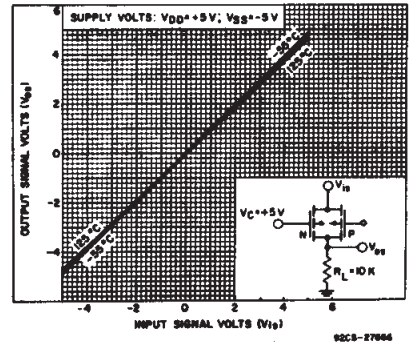

Fig. 7—Typ. on-state characteristics as a function of temp. for 1 of 4 switches with V<sub>DD</sub> = +5 V, V<sub>SS</sub> = -5 V.

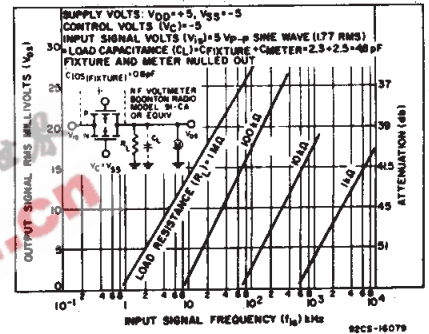

Fig. 8—Typ. feedthrough vs. frequency - switch off.

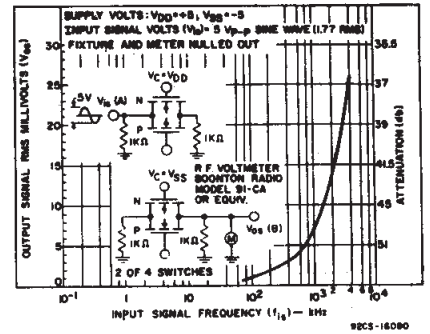

Fig. 9—Typical crosstalk between switch circuits in the same package.

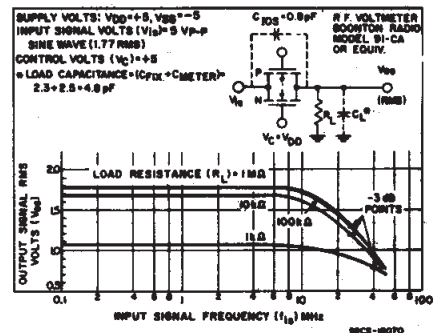

Fig. 11—Typical frequency response - switch on.

V <sub>DD</sub> (V)	V <sub>is</sub> (V)	Switch Input I <sub>is</sub> (mA)						Switch Output V <sub>OS</sub> (V)	
		I <sub>is</sub> (mA)						Min.	Max.
		-55°C	-40°C	25°C*	25°C▲	+85°C	+125°C		
5	0	0.25	0.2	0.2	0.16	0.12	0.14	-	0.4
5	5	-0.25	-0.2	-0.2	-0.16	-0.12	-0.14	4.6	-
10	0	0.62	0.5	0.5	0.4	0.3	0.35	-	0.5
10	10	-0.62	-0.5	-0.5	-0.4	-0.3	-0.35	9.5	-
15	0	1.8	1.4	1.5	1.2	1	1.1	-	1.5
15	15	-1.8	-1.4	-1.5	-1.2	-1	-1.1	13.5	-

\* Plastic package

▲ Ceramic package

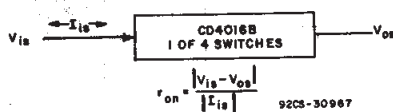

Fig. 10—Determination of r<sub>on</sub> as a test condition for control input high voltage (V<sub>IHC</sub>) specification.

# CD4016B Types

TYPICAL ON-STATE RESISTANCE CHARACTERISTICS,  $T_A = 25^\circ\text{C}$

CHARACTERISTIC*	SUPPLY CONDITIONS		LOAD CONDITIONS					
			$R_L = 1\text{k}\Omega$		$R_L = 10\text{k}\Omega$		$R_L = 100\text{k}\Omega$	
	$V_{DD}$ (V)	$V_{SS}$ (V)	VALUE ( $\Omega$ )	$V_{is}$ (V)	VALUE ( $\Omega$ )	$V_{is}$ (V)	VALUE ( $\Omega$ )	$V_{is}$ (V)
$r_{on}$	+15	0	200	+15	200	+15	180	+15
$r_{on}$ (max.)	+15	0	300	+11	300	+9.3	320	+9.2
$r_{on}$	+10	0	290	+10	250	+10	240	+10
$r_{on}$ (max.)	+10	0	290	0	250	0	300	0
$r_{on}$	+5	0	860	+5	470	+5	450	+5
$r_{on}$ (max.)	+5	0	600	0	580	0	800	0
$r_{on}$	+7.5	-7.5	200	+7.5	200	+7.5	180	+7.5
$r_{on}$ (max.)	+7.5	-7.5	290	$\pm 0.25$	280	$\pm 25$	400	$\pm 0.25$
$r_{on}$	+5	-5	260	+5	250	+5	240	+5
$r_{on}$ (max.)	+5	-5	310	-5	250	-5	240	-5
$r_{on}$	+2.5	-2.5	590	+2.5	450	+2.5	490	+2.5
$r_{on}$ (max.)	+2.5	-2.5	720	-2.5	520	-2.5	520	-2.5
$r_{on}$	+2.5	-2.5	232k	$\pm 0.25$	300k	$\pm 0.25$	870k	$\pm 0.25$

\* Variation from perfect switch,  $r_{on} = 0 \Omega$ .

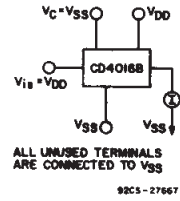

Fig. 12 - Off-state switch input or output leakage current test circuit.

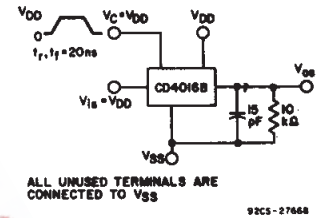
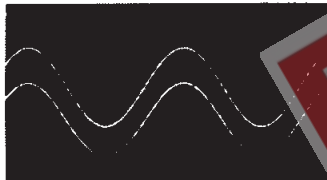

Fig. 13 - Test circuit for square-wave response.



SCALE: X = 0.2 ms/DIV Y = 2.0 V/DIV  
 $V_{DD} = V_C = +7.5\text{V}$ ,  $V_{SS} = -7.5\text{V}$ ,  $R_L = 10\text{k}\Omega$   
 $C_L = 15\text{pF}$   
 $f_{IS} = 1\text{KHz}$   $V_{IS} = 5\text{V p-p}$   
 DISTORTION = 0.2%

92CS-27612

Fig. 14 - Typical sine wave response of  $V_{DD} = +7.5\text{V}$ ,  $V_{SS} = -7.5\text{V}$ .



SCALE: X = 0.2 ms/DIV Y = 2.0 V/DIV  
 $V_{DD} = V_C = +5\text{V}$ ,  $V_{SS} = -5\text{V}$ ,  $R_L = 10\text{k}\Omega$   
 $C_L = 15\text{pF}$   
 $f_{IS} = 1\text{KHz}$   $V_{IS} = 5\text{V p-p}$   
 DISTORTION = 0.4%

92CS-27613

Fig. 15 - Typical sine wave response of  $V_{DD} = +5\text{V}$ ,  $V_{SS} = -5\text{V}$ .

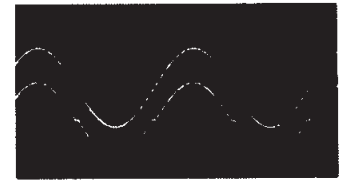

SCALE: X = 0.2 ms/DIV Y = 2.0 V/DIV  
 $V_{DD} = V_C = +2.5\text{V}$ ,  $V_{SS} = -2.5\text{V}$ ,  $R_L = 10\text{k}\Omega$   
 $C_L = 15\text{pF}$   
 $f_{IS} = 1\text{KHz}$   $V_{IS} = 5\text{V p-p}$   
 DISTORTION = 3%

92CS-27614

Fig. 16 - Typical sine wave response of  $V_{DD} = +2.5\text{V}$ ,  $V_{SS} = -2.5\text{V}$ .



SCALE: X = 100 ns/DIV  
 Y = 5.0 V/DIV

92CS-27615

Fig. 17 - Typical square wave response at  $V_{DD} = V_C = +15\text{V}$ ,  $V_{SS} = \text{Gnd}$ .



SCALE: X = 100 ns/DIV  
 Y = 5.0 V/DIV

92CS-27616

Fig. 18 - Typical square wave response at  $V_{DD} = V_C = +10\text{V}$ ,  $V_{SS} = \text{Gnd}$ .



SCALE: X = 100 ns/DIV  
 Y = 2 V/DIV

92CS-27617

Fig. 19 - Typical square wave response at  $V_{DD} = V_C = +5\text{V}$ ,  $V_{SS} = \text{Gnd}$ .

COMMERCIAL CMOS  
 HIGH VOLTAGE ICs

# CD4016B Types

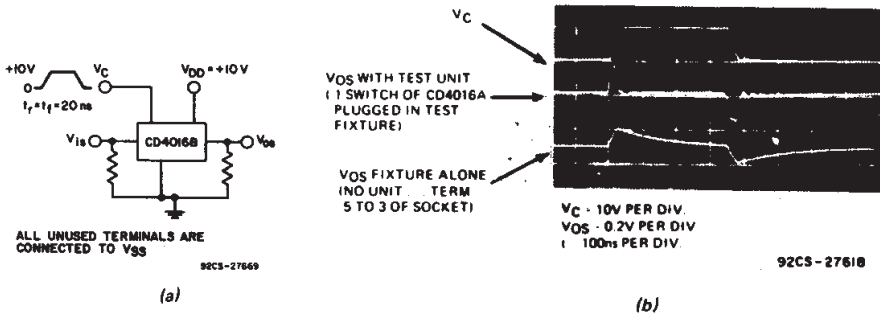

Fig. 20 - Crosstalk-control input to signal output.

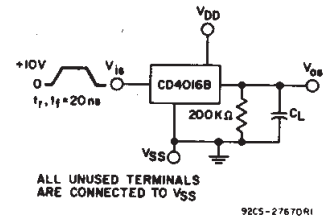

Fig. 21 - Propagation delay time signal input ( $V_{is}$ ) to signal output ( $V_{os}$ ).

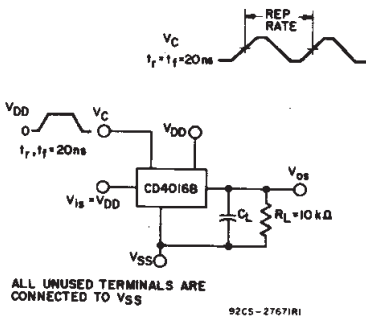

Fig. 22 - Max. control-input repetition rate.

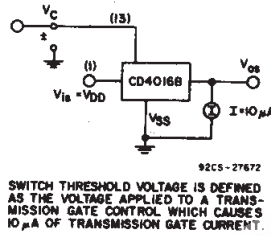

Fig. 23 - Switch threshold voltage.

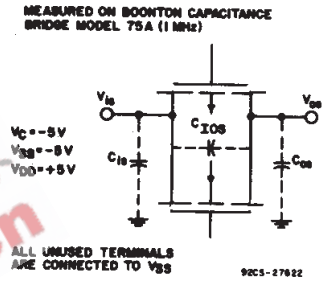

Fig. 24 - Capacitance  $C_{ios}$  and  $C_{os}$ .

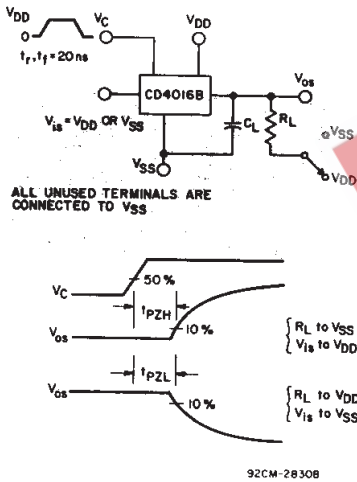
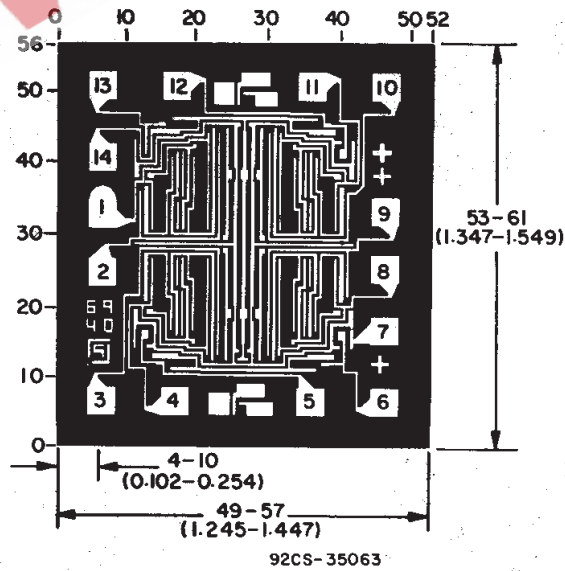

Fig. 25 - Turn-On propagation delay-control input.

## Dimensions and pad layout for CD4016BH



Dimensions in parentheses are in millimeters and are derived from the basic inch dimensions as indicated. Grid graduations are in mils ( $10^{-3}$  inch).

## IMPORTANT NOTICE

Texas Instruments and its subsidiaries (TI) reserve the right to make changes to their products or to discontinue any product or service without notice, and advise customers to obtain the latest version of relevant information to verify, before placing orders, that information being relied on is current and complete. All products are sold subject to the terms and conditions of sale supplied at the time of order acknowledgement, including those pertaining to warranty, patent infringement, and limitation of liability.

TI warrants performance of its semiconductor products to the specifications applicable at the time of sale in accordance with TI's standard warranty. Testing and other quality control techniques are utilized to the extent TI deems necessary to support this warranty. Specific testing of all parameters of each device is not necessarily performed, except those mandated by government requirements.

CERTAIN APPLICATIONS USING SEMICONDUCTOR PRODUCTS MAY INVOLVE POTENTIAL RISKS OF DEATH, PERSONAL INJURY, OR SEVERE PROPERTY OR ENVIRONMENTAL DAMAGE ("CRITICAL APPLICATIONS"). TI SEMICONDUCTOR PRODUCTS ARE NOT DESIGNED, AUTHORIZED, OR WARRANTED TO BE SUITABLE FOR USE IN LIFE-SUPPORT DEVICES OR SYSTEMS OR OTHER CRITICAL APPLICATIONS. INCLUSION OF TI PRODUCTS IN SUCH APPLICATIONS IS UNDERSTOOD TO BE FULLY AT THE CUSTOMER'S RISK.

In order to minimize risks associated with the customer's applications, adequate design and operating safeguards must be provided by the customer to minimize inherent or procedural hazards.

TI assumes no liability for applications assistance or customer product design. TI does not warrant or represent that any license, either express or implied, is granted under any patent right, copyright, mask work right, or other intellectual property right of TI covering or relating to any combination, machine, or process in which such semiconductor products or services might be or are used. TI's publication of information regarding any third party's products or services does not constitute TI's approval, warranty or endorsement thereof.