

## CD4031BM/CD4031BC 64-Stage Static Shift Register

### General Description

The CD4031BM/CD4031BC is an integrated, complementary MOS (CMOS), 64-stage, fully static shift register. Two data inputs, DATA IN and RECIRCULATE IN, and a MODE CONTROL input are provided. Data at the DATA input (when MODE CONTROL is low) or data at the RECIRCULATE input (when MODE CONTROL is high), which meets the setup and hold time requirements, is entered into the first stage of the register and is shifted one stage at each positive transition of the CLOCK.

Data output is available in both true and complement forms from the 64th stage. Both the DATA OUT (Q) AND  $\overline{\text{DATA OUT}}$  (Q̄) outputs are fully buffered.

The CLOCK input of the CD4031BM/CD4031BC is fully buffered, and present only a standard input load capacitance. However, a DELAYED CLOCK OUTPUT (CL<sub>D</sub>) has been provided to allow reduced clock drive fan-out and transition time requirements when cascading packages.

### Features

- Wide supply voltage range 3.0V to 15V
- High noise immunity 0.45 V<sub>DD</sub> (typ.)
- Low power TTL compatibility fan out of 2 driving 74L or 1 driving 74LS
- Fully static operation DC to 8 MHz
- Fully buffered clock input V<sub>DD</sub> = 10V (typ.)
- Single phase clocking requirements 5 pF (typ.) input capacitance
- Delayed clock output for reduced clock drive requirements
- Fully buffered outputs
- High current sinking capability 1.6 mA @ V<sub>DD</sub> = 5V and 25°C
- Q output

### Logic and Connection Diagrams

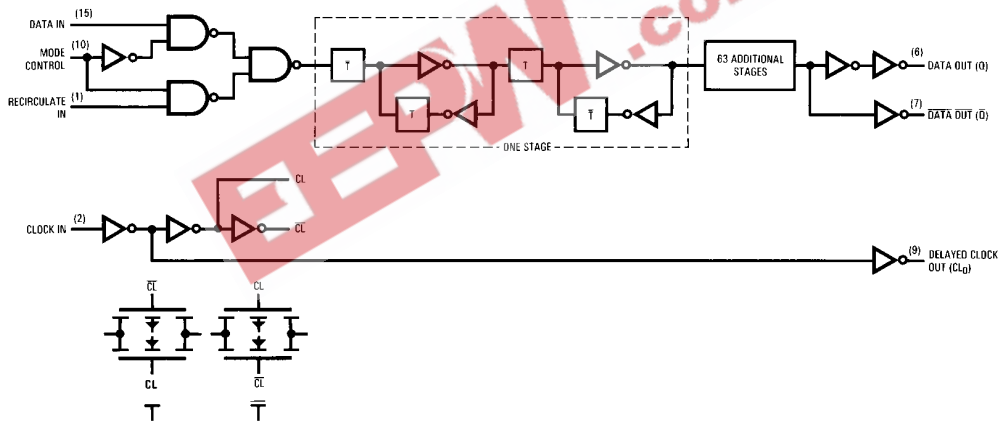

TL/F/5962-1

### Dual-In-Line Package

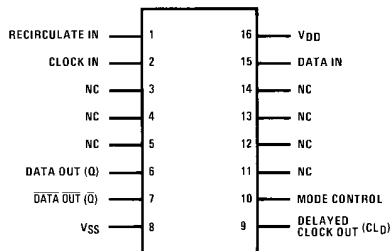

Top View

TL/F/5962-2

Order Number CD4031B

### Absolute Maximum Ratings (Notes 1 and 2)

If Military/Aerospace specified devices are required, please contact the National Semiconductor Sales Office/Distributors for availability and specifications.

Supply Voltage ( $V_{DD}$ )	-0.5V to +18V
Input Voltage ( $V_{IN}$ )	-0.5V to $V_{DD}$ + 0.5V
Storage Temperature Range ( $T_S$ )	-65°C to +150°C
Power Dissipation ( $P_D$ )	
Dual-In-Line	700 mW
Small Outline	500 mW
Lead Temp. ( $T_L$ ) (Soldering, 10 sec.)	260°C

### Recommended Operating Conditions (Note 2)

Supply Voltage ( $V_{DD}$ )	3V to 15V
Input Voltage ( $V_{IN}$ )	0V to $V_{DD}$
Operating Temperature Range ( $T_A$ )	
CD4031BM	-55°C to +125°C
CD4031BC	-40°C to +85°C

### DC Electrical Characteristics (Note 2) CD4031BM

Symbol	Parameter	Conditions	-55°C		+25°C			+125°C		Units
			Min	Max	Min	Typ	Max	Min	Max	
$I_{DD}$	Quiescent Device Current	$V_{DD} = 5V, V_{IN} = V_{DD}$ or $V_{SS}$ $V_{DD} = 10V, V_{IN} = V_{DD}$ or $V_{SS}$ $V_{DD} = 15V, V_{IN} = V_{DD}$ or $V_{SS}$		5		0.01	5		150	$\mu A$
				10		0.01	10		300	$\mu A$
				20		0.02	20		600	$\mu A$
$V_{OL}$	Low Level Output Voltage	$V_{DD} = 5V$ $V_{DD} = 10V$ $V_{DD} = 15V$ } $V_{IH} = V_{DD}, V_{IL} = 0V,  I_O  < 1 \mu A$		0.05		0	0.05		0.05	V
				0.05		0	0.05		0.05	V
				0.05		0	0.05		0.05	V
$V_{OH}$	High Level Output Voltage	$V_{DD} = 5V$ $V_{DD} = 10V$ $V_{DD} = 15V$ } $V_{IH} = V_{DD}, V_{IL} = 0V,  I_O  < 1 \mu A$	4.95		4.95	5	4.95			V
			9.95		9.95	10	9.95			V
			14.95		14.95	15	14.95			V
$V_{IL}$	Low Level Input Voltage	$V_{DD} = 5V, V_O = 0.5V$ or $4.5V$ $V_{DD} = 10V, V_O = 1.0V$ or $9.0V$ $V_{DD} = 15V, V_O = 1.5V$ or $13.5V$ } $ I_O  < 1 \mu A$	1.5		2.25	1.5		1.5	V	
			3.0		4.5	3.0		3.0	V	
			4.0		6.75	4.0		4.0	V	
$V_{IH}$	High Level Input Voltage	$V_{DD} = 5V, V_O = 0.5V$ or $4.5V$ $V_{DD} = 10V, V_O = 1.0V$ or $9.0V$ $V_{DD} = 15V, V_O = 1.5V$ or $13.5V$ } $ I_O  < 1 \mu A$	3.5		3.5	2.75		3.5	V	
			7.0		7.0	5.5		7.0	V	
			11.0		11.0	8.25		11.0	V	
$I_{OL}$	Low Level Output Current, Q Output (Note 3)	$V_{DD} = 5V, V_O = 0.4V$ $V_{DD} = 10V, V_O = 0.5V$ $V_{DD} = 15V, V_O = 1.5V$ } $V_{IH} = V_{DD}, V_{IL} = 0V$	2.3		1.9	3.8		1.3	mA	
			5.1		4.2	8.4		2.8	mA	
			10.5		8.8	17		6.1	mA	
$I_{OL}$	Low Level Output Current, $\bar{Q}$ and $CL_D$ Outputs (Note 3)	$V_{DD} = 5V, V_O = 0.4V$ $V_{DD} = 10V, V_O = 0.5V$ $V_{DD} = 15V, V_O = 1.5V$ } $V_{IH} = V_{DD}, V_{IL} = 0V$	0.64		0.51	0.88		0.36	mA	
			1.6		1.3	2.25		0.9	mA	
			4.2		3.4	8.8		2.4	mA	
$I_{OH}$	High Level Output Current, All Outputs (Note 3)	$V_{DD} = 5V, V_O = 4.6V$ $V_{DD} = 10V, V_O = 9.5V$ $V_{DD} = 15V, V_O = 13.5V$ } $V_{IH} = V_{DD}, V_{IL} = 0V$	-0.64		-0.51	-0.88		-0.36	mA	
			-1.6		-1.3	-2.25		-0.9	mA	
			-4.2		-3.4	-8.8		-2.4	mA	
$I_{IN}$	Input Current	$V_{DD} = 15V, V_{IN} = 0V$ $V_{DD} = 15V, V_{IN} = 15V$		-0.1		$-10^{-5}$	-0.1		$-1.0 \mu A$	
				0.1		$10^{-5}$	0.1		$1.0 \mu A$	

### Truth Tables

#### Mode Control (Data Selection)

Mode Control	Data In	Recirculate In	Data Into First Stage
0	0	X	0
0	1	X	1
1	X	0	0
1	X	1	1

#### Each Stage

$D_n$	CL	$Q_n$
0		0
1		1
X		NC

X = irrelevant    NC = no change     = Low to High level transition     = High to Low level transition

## DC Electrical Characteristics (Note 2) CD4031BC

Symbol	Parameter	Conditions	-40°C		+25°C			+85°C		Units
			Min	Max	Min	Typ	Max	Min	Max	
I <sub>DD</sub>	Quiescent Device Current	V <sub>DD</sub> = 5V, V <sub>IN</sub> = V <sub>DD</sub> or V <sub>SS</sub>		20		0.01	20		150	μA
		V <sub>DD</sub> = 10V, V <sub>IN</sub> = V <sub>DD</sub> or V <sub>SS</sub>		40		0.01	40		300	μA
		V <sub>DD</sub> = 15V, V <sub>IN</sub> = V <sub>DD</sub> or V <sub>SS</sub>		80		0.02	80		600	μA
V <sub>OL</sub>	Low Level Output Voltage	V <sub>DD</sub> = 5V } V <sub>IH</sub> = V <sub>DD</sub> , V <sub>IL</sub> = 0V,  I <sub>O</sub>   < 1 μA		0.05		0	0.05		0.05	V
		V <sub>DD</sub> = 10V }		0.05		0	0.05		0.05	V
		V <sub>DD</sub> = 15V }		0.05		0	0.05		0.05	V
V <sub>OH</sub>	High Level Output Voltage	V <sub>DD</sub> = 5V } V <sub>IH</sub> = V <sub>DD</sub> , V <sub>IL</sub> = 0V,  I <sub>O</sub>   < 1 μA	4.95		4.95	5		4.95		V
		V <sub>DD</sub> = 10V }	9.95		9.95	10		9.95		V
		V <sub>DD</sub> = 15V }	14.95		14.95	15		14.95		V
V <sub>IL</sub>	Low Level Input Voltage	V <sub>DD</sub> = 5V, V <sub>O</sub> = 0.5V or 4.5V }  I <sub>O</sub>   < 1 μA		1.5		2.25	1.5		1.5	V
		V <sub>DD</sub> = 10V, V <sub>O</sub> = 1.0V or 9.0V }		3.0		4.5	3.0		3.0	V
		V <sub>DD</sub> = 15V, V <sub>O</sub> = 1.5V or 13.5V }		4.0		6.75	4.0		4.0	V
V <sub>IH</sub>	High Level Input Voltage	V <sub>DD</sub> = 5V, V <sub>O</sub> = 0.5V or 4.5V }  I <sub>O</sub>   < 1 μA	3.5		3.5	2.75		3.5		V
		V <sub>DD</sub> = 10V, V <sub>O</sub> = 1.0V or 9.0V }	7.0		7.0	5.5		7.0		V
		V <sub>DD</sub> = 15V, V <sub>O</sub> = 1.5V or 13.5V }	11.0		11.0	8.25		11.0		V
I <sub>OL</sub>	Low Level Output Current, Q Output (Note 3)	V <sub>DD</sub> = 5V, V <sub>O</sub> = 0.4V } V <sub>IH</sub> = V <sub>DD</sub>	1.8		1.6	3.8		1.3		mA
		V <sub>DD</sub> = 10V, V <sub>O</sub> = 0.5V } V <sub>IL</sub> = 0V	4.0		3.5	8.4		2.8		mA
		V <sub>DD</sub> = 15V, V <sub>O</sub> = 1.5V }	8.7		7.5	17		6.1		mA
I <sub>OL</sub>	Low Level Output Current, Q̄ and CL <sub>D</sub> Outputs (Note 3)	V <sub>DD</sub> = 5V, V <sub>O</sub> = 0.4V } V <sub>IH</sub> = V <sub>DD</sub>	0.52		0.44	0.88		0.36		mA
		V <sub>DD</sub> = 10V, V <sub>O</sub> = 0.5V } V <sub>IL</sub> = 0V	1.3		1.1	2.25		0.9		mA
		V <sub>DD</sub> = 15V, V <sub>O</sub> = 1.5V }	3.6		3.0	8.8		2.4		mA
I <sub>OH</sub>	High Level Output Current, All Outputs (Note 3)	V <sub>DD</sub> = 5V, V <sub>O</sub> = 4.6V } V <sub>IH</sub> = V <sub>DD</sub>	-0.52		-0.44	-0.88		-0.36		mA
		V <sub>DD</sub> = 10V, V <sub>O</sub> = 9.5V } V <sub>IL</sub> = 0V	-1.3		-1.1	-2.25		-0.9		mA
		V <sub>DD</sub> = 15V, V <sub>O</sub> = 13.5V }	-3.0		-3.0	-8.8		-2.4		mA
I <sub>IN</sub>	Input Current	V <sub>DD</sub> = 15V, V <sub>IN</sub> = 0V		-0.3		-10 <sup>-5</sup>		-0.3		μA
		V <sub>DD</sub> = 15V, V <sub>IN</sub> = 15V		0.3		10 <sup>-5</sup>		0.3		μA

**Note 1:** "Absolute Maximum Ratings" are those values beyond which the safety of the device cannot be guaranteed. They are not meant to imply that the devices should be operated at these limits. The tables of "Recommended Operating Conditions" and "Electrical Characteristics" provide conditions for actual device operation.

**Note 2:** V<sub>SS</sub> = 0V unless otherwise specified.

**Note 3:** I<sub>OH</sub> and I<sub>OL</sub> are tested one output at a time.

## Switching Time Waveforms

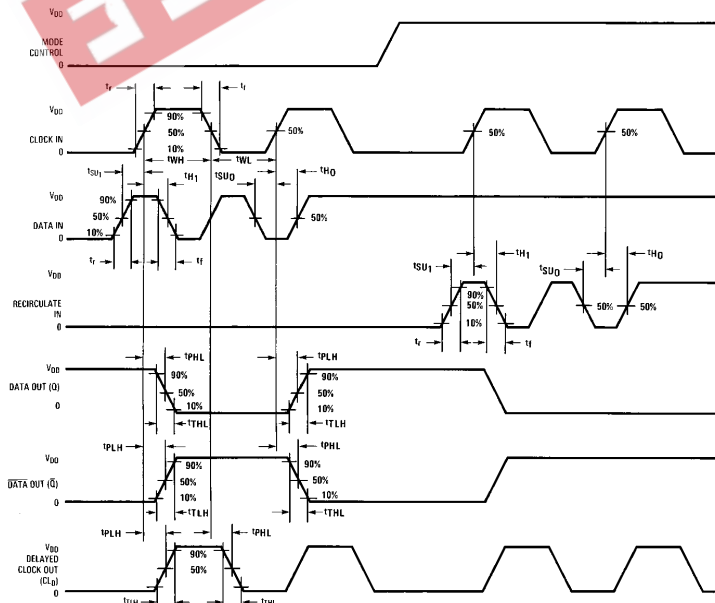

TL/F/5962-3

## AC Electrical Characteristics\*

$T_A = 25^\circ\text{C}$ ,  $C_L = 50\text{ pF}$ ,  $R_L = 200\text{ k}$ , Input  $t_r = t_f = 20\text{ ns}$ , unless otherwise specified

Symbol	Parameter	Conditions	Min	Typ	Max	Units
$t_{PHL}$ , $t_{PLH}$	Propagation Delay Time, Clock to Q and $\bar{Q}$	$V_{CC} = 5\text{V}$ $V_{CC} = 10\text{V}$ $V_{CC} = 15\text{V}$		300 125 100	600 250 200	ns ns ns
$t_{PHL}$ , $t_{PLH}$	Propagation Delay Time, Clock to $CL_D$	$V_{CC} = 5\text{V}$ $V_{CC} = 10\text{V}$ $V_{CC} = 15\text{V}$		125 60 50	250 125 100	ns ns ns
$t_{THL}$ , $t_{TLH}$	Output Transition Time, All Outputs	$V_{CC} = 5\text{V}$ $V_{CC} = 10\text{V}$ $V_{CC} = 15\text{V}$		100 50 40	200 100 80	ns ns ns
$t_{SU0}$ $t_{SU1}$	Minimum Data Setup Time, DATA IN or RECIRCULATE IN to Clock	$V_{CC} = 5\text{V}$ $V_{CC} = 10\text{V}$ $V_{CC} = 15\text{V}$		100 50 40	200 100 80	ns ns ns
$t_{H0}$ $t_{H1}$	Minimum Data Hold Time, Clock to DATA IN or RECIRCULATE IN	$V_{CC} = 5\text{V}$ $V_{CC} = 10\text{V}$ $V_{CC} = 15\text{V}$		100 50 40	200 100 80	ns ns ns
$t_{WL}$ , $t_{WH}$	Minimum Clock Pulse Width	$V_{CC} = 5\text{V}$ $V_{CC} = 10\text{V}$ $V_{CC} = 15\text{V}$		150 60 50	30 125 100	ns ns ns
$f_{CL}$	Maximum Clock Frequency	$V_{CC} = 5\text{V}$ $V_{CC} = 10\text{V}$ $V_{CC} = 15\text{V}$	1.6 4.0 5.0	3.2 8.0 10		MHz MHz MHz
$t_{RCL}$ , $t_{FCL}$	Maximum Clock Input Rise and Fall Times (Note 4)	$V_{CC} = 5\text{V}$ $V_{CC} = 10\text{V}$ $V_{CC} = 15\text{V}$	15 10 5			$\mu\text{s}$ $\mu\text{s}$ $\mu\text{s}$
$C_{IN}$	Input Capacitance	Any Input		5	7.5	pF

\*AC Parameters are guaranteed by DC correlated testing.

**Note 4:** When clocking cascaded packages in parallel, one should insure that:  $t_{r,CL} \leq 2(t_{PD} - t_H)$  where:  $t_{PD}$  = the propagation delay of the driving stage and  $t_H$  = the hold time of the driven stage.

## Block Diagram

cascading packages using DELAYED CLOCK ( $CL_D$ ) output

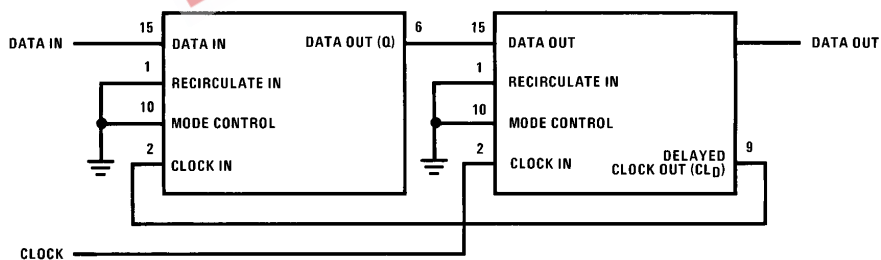

TL/F/5962-4

**Physical Dimensions** inches (millimeters)

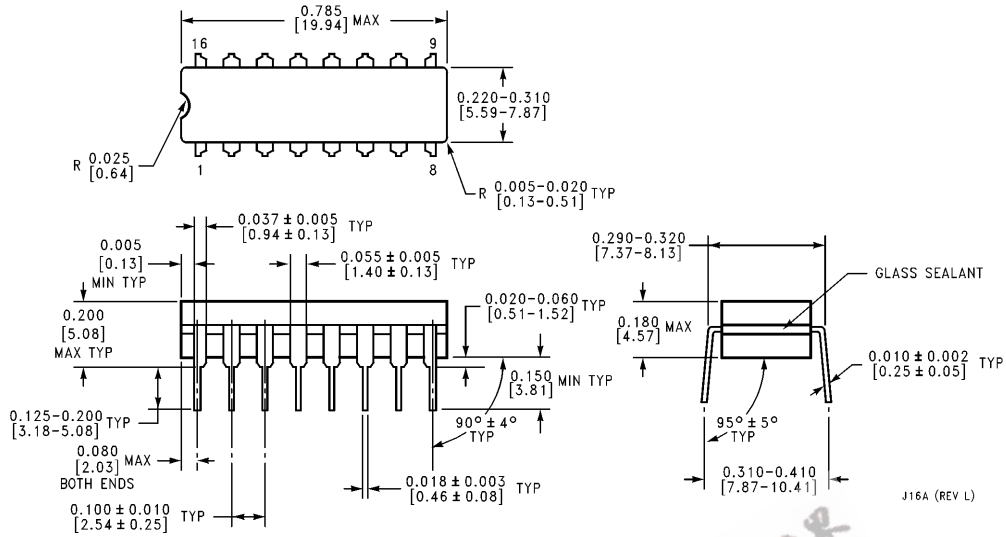

**Ceramic Dual-In-Line Package (J)**  
**Order Number CD4031BMJ or CD4031BCJ**  
**NS Package Number J16A**

J16A (REV L)

EEPW.com.cn 电子产品世界

**Physical Dimensions** inches (millimeters) (Continued)

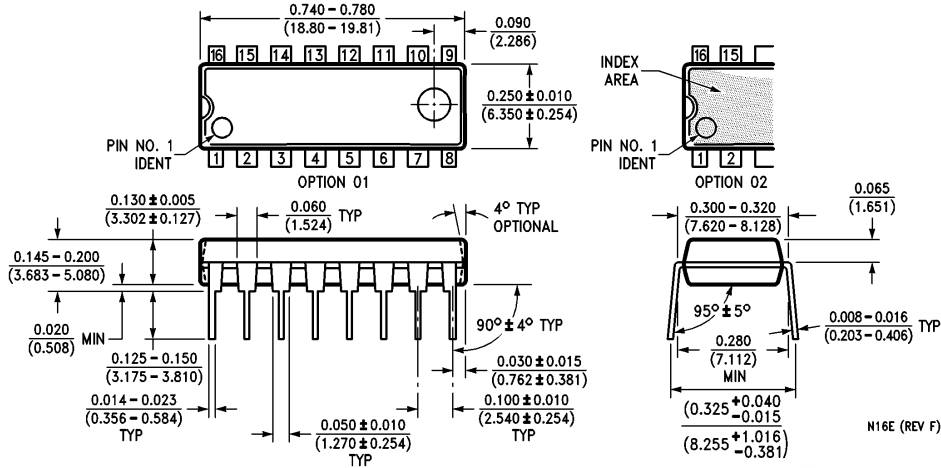

**Molded Dual-In-Line Package (N)**  
**Order Number CD4031BMN or CD4031BCN**  
**NS Package Number N16E**



**LIFE SUPPORT POLICY**

NATIONAL'S PRODUCTS ARE NOT AUTHORIZED FOR USE AS CRITICAL COMPONENTS IN LIFE SUPPORT DEVICES OR SYSTEMS WITHOUT THE EXPRESS WRITTEN APPROVAL OF THE PRESIDENT OF NATIONAL SEMICONDUCTOR CORPORATION. As used herein:

1. Life support devices or systems are devices or systems which, (a) are intended for surgical implant into the body, or (b) support or sustain life, and whose failure to perform, when properly used in accordance with instructions for use provided in the labeling, can be reasonably expected to result in a significant injury to the user.
2. A critical component is any component of a life support device or system whose failure to perform can be reasonably expected to cause the failure of the life support device or system, or to affect its safety or effectiveness.

 <p><b>National Semiconductor Corporation</b>          1111 West Bardin Road          Arlington, TX 76017          Tel: 1(800) 272-9959          Fax: 1(800) 737-7018</p>	<p><b>National Semiconductor Europe</b>          Fax: (+49) 0-180-530 85 86          Email: cnjwge@levm2.nsc.com          Deutsch Tel: (+49) 0-180-530 85 85          English Tel: (+49) 0-180-532 78 32          Français Tel: (+49) 0-180-532 93 58          Italiano Tel: (+49) 0-180-534 16 80</p>	<p><b>National Semiconductor Hong Kong Ltd.</b>          13th Floor, Straight Block,          Ocean Centre, 5 Canton Rd.          Tsimshatsui, Kowloon          Hong Kong          Tel: (852) 2737-1600          Fax: (852) 2736-9960</p>	<p><b>National Semiconductor Japan Ltd.</b>          Tel: 81-043-299-2309          Fax: 81-043-299-2408</p>
--	--	---	---

National does not assume any responsibility for use of any circuitry described, no circuit patent licenses are implied and National reserves the right at any time without notice to change said circuitry and specifications.