

DDTC (R2-ONLY SERIES) KA

**NPN PRE-BIASED SMALL SIGNAL SC-59
SURFACE MOUNT TRANSISTOR**

NEW PRODUCT

Features

- Epitaxial Planar Die Construction
- Complementary PNP Types Available (DDTA)
- Built-In Biasing Resistor, R2 only

Mechanical Data

- Case: SC-59, Molded Plastic
- Case material - UL Flammability Rating 94V-0
- Moisture sensitivity: Level 1 per J-STD-020A
- Terminals: Solderable per MIL-STD-202, Method 208
- Terminal Connections: See Diagram
- Marking: Date Code and Marking Code (See Diagrams & Page 2)
- Weight: 0.006 grams (approx.)
- Ordering Information (See Page 2)

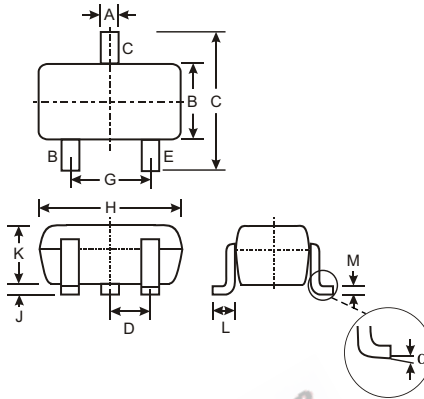

SC-59		
Dim	Min	Max
A	0.35	0.50
B	1.50	1.70
C	2.70	3.00
D	0.95	
G	1.90	
H	2.90	3.10
J	0.013	0.10
K	1.00	1.30
L	0.35	0.55
M	0.10	0.20
α	0°	8°
All Dimensions in mm		

P/N	R2 (NOM)	MARKING
DDTC114GKA	10K Ω	N26
DDTC124GKA	22K Ω	N27
DDTC144GKA	47K Ω	N28
DDTC115GKA	100K Ω	N29

SCHEMATIC DIAGRAM

Maximum Ratings @ T_A = 25°C unless otherwise specified

Characteristic	Symbol	Value	Unit
Collector-Base Voltage	V _{CBO}	50	V
Collector-Emitter Voltage	V _{CEO}	50	V
Emitter-Base Voltage	V _{EBO}	5	V
Collector Current	I _C (Max)	100	mA
Power Dissipation	P _d	200	mW
Thermal Resistance, Junction to Ambient Air (Note 1)	R _{θJA}	625	°C/W
Operating and Storage and Temperature Range	T _j , T _{STG}	-55 to +150	°C

Note: 1. Mounted on FR4 PC Board with recommended pad layout at <http://www.diodes.com/datasheets/ap02001.pdf>.

Electrical Characteristics @ $T_A = 25^\circ\text{C}$ unless otherwise specified

Characteristic		Symbol	Min	Typ	Max	Unit	Test Condition
Collector-Base Breakdown Voltage		BV_{CBO}	50	—	—	V	$I_C = 50\mu\text{A}$
Collector-Emitter Breakdown Voltage		BV_{CEO}	50	—	—	V	$I_C = 1\text{mA}$
Emitter-Base Breakdown Voltage		BV_{EBO}	5	—	—	V	$I_E = 720\mu\text{A}$, DDTC114GKA $I_E = 330\mu\text{A}$, DDTC124GKA $I_E = 160\mu\text{A}$, DDTC144GKA $I_E = 72\mu\text{A}$, DDTC115GKA
Collector Cutoff Current		I_{CBO}	—	—	0.5	μA	$V_{CB} = 50\text{V}$
Emitter Cutoff Current		I_{EBO}	300 140 65 30	—	580 260 130 58	μA	$V_{EB} = 4\text{V}$
Collector-Emitter Saturation Voltage		$V_{CE(sat)}$	—	—	0.3	V	$I_C = 10\text{mA}$, $I_B = 0.5\text{mA}$
DC Current Transfer Ratio		h_{FE}	30 56 68 82	—	—	—	$I_C = 5\text{mA}$, $V_{CE} = 5\text{V}$
Bleeder Resistor (R_2) Tolerance		DR_2	-30	—	+30	%	—
Gain-Bandwidth Product*		f_T	—	250	—	MHz	$V_{CE} = 10\text{V}$, $I_E = -5\text{mA}$, $f = 100\text{MHz}$

* Transistor - For Reference Only

Ordering Information (Note 2)

Device	Packaging	Shipping
DDTC114GKA-7	SC-59	3000/Tape & Reel
DDTC124GKA-7	SC-59	3000/Tape & Reel
DDTC144GKA-7	SC-59	3000/Tape & Reel
DDTC115GKA-7	SC-59	3000/Tape & Reel

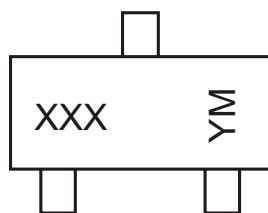
Notes: 2. For Packaging Details, go to our website at <http://www.diodes.com/datasheets/ap02007.pdf>.**Marking Information**

XXX = Product Type Marking Code
See Sheet 1 Diagrams
YM = Date Code Marking
Y = Year ex: N = 2002
M = Month ex: 9 = September

Date Code Key

Year	2002	2003	2004	2005	2006	2007	2008	2009
Code	N	P	R	S	T	U	V	W

Month	Jan	Feb	March	Apr	May	Jun	Jul	Aug	Sep	Oct	Nov	Dec
Code	1	2	3	4	5	6	7	8	9	O	N	D

TYPICAL CURVES - DDTC114GKA

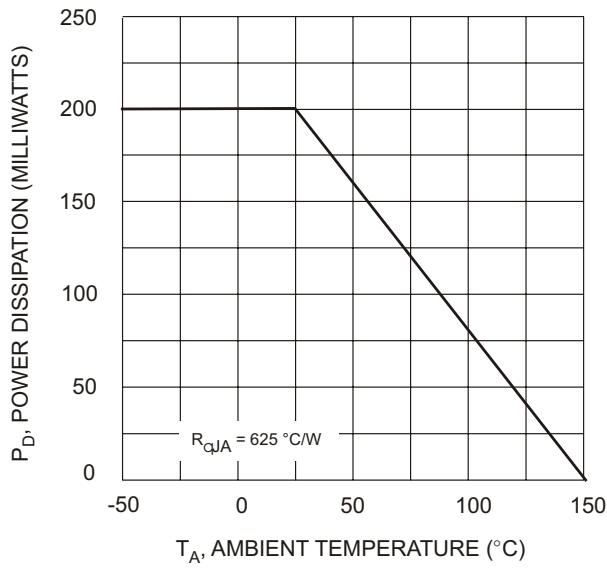

Fig. 1 Derating Curve

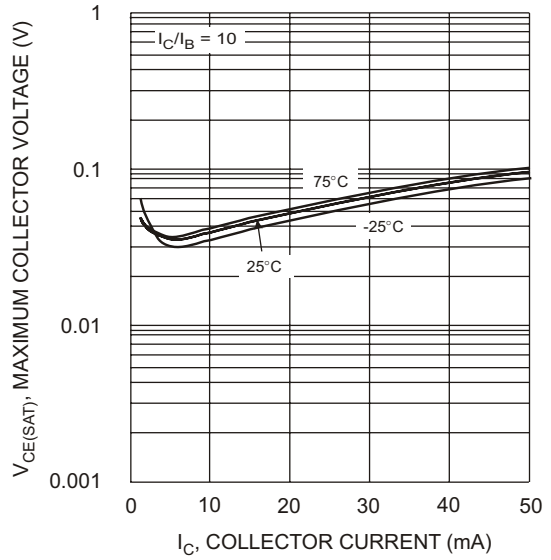

Fig. 2 $V_{CE(SAT)}$ vs. I_C

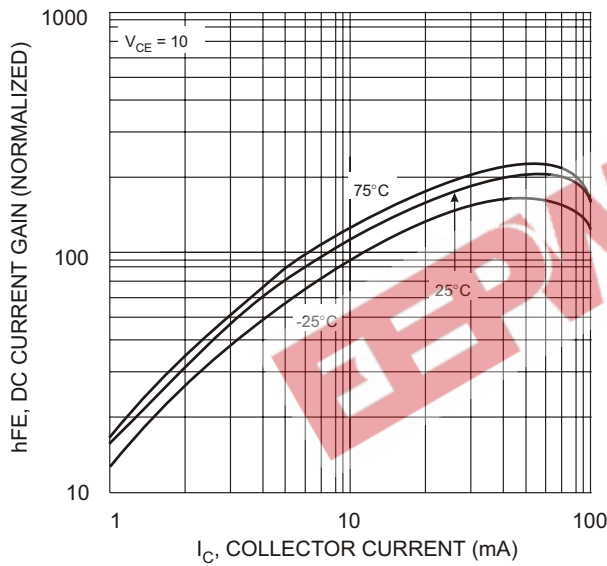

Fig. 3 DC CURRENT GAIN

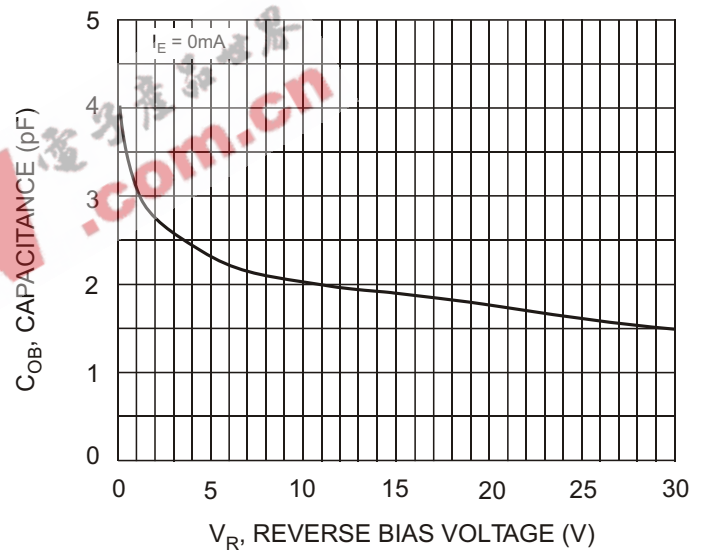

Fig. 4 Output Capacitance

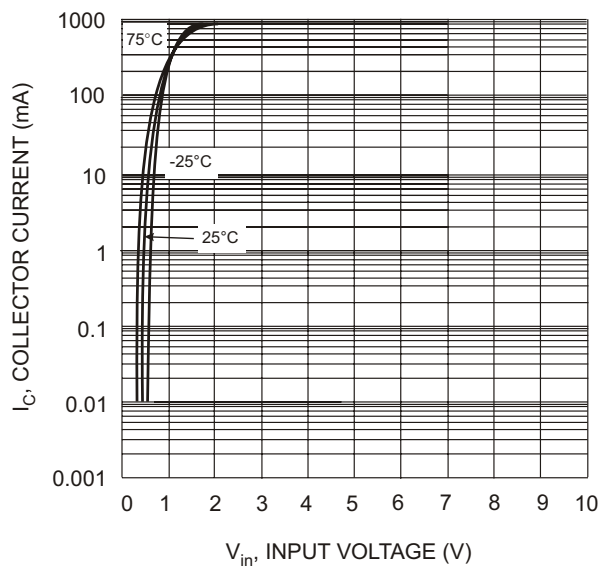

Fig. 5 Collector Current Vs. Input Voltage

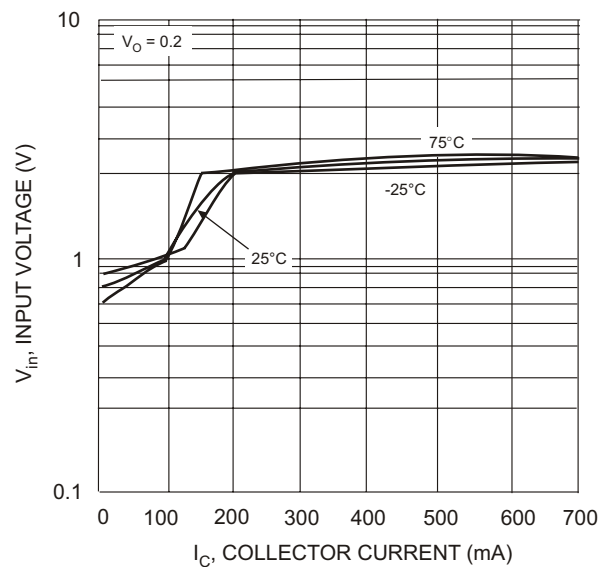

Fig. 6 Input Voltage vs. Collector Current