

**Features**

- Epitaxial Planar Die Construction
- Complementary PNP Types Available (DDTA)
- Built-In Biasing Resistor, R2 only
- **Lead Free/RoHS Compliant (Note 2)**
- "Green" Device, Note 3 and 4

**Mechanical Data**

- Case: SC-59
- Case Material: Molded Plastic, "Green" Molding Compound, Note 4. UL Flammability Classification Rating 94V-0
- Moisture Sensitivity: Level 1 per J-STD-020C
- Terminals: Solderable per MIL-STD-202, Method 208
- Lead Free Plating (Matte Tin Finish annealed over Copper leadframe).
- Terminal Connections: See Diagram
- Marking: Date Code and Type Code (See Table Below & Page 2)
- Ordering Information (See Page 2)
- Weight: 0.006 grams (approximate)

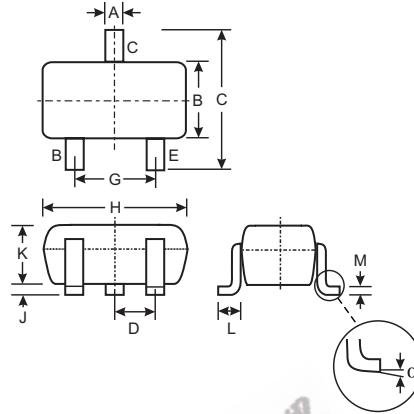

SC-59		
Dim	Min	Max
A	0.35	0.50
B	1.50	1.70
C	2.70	3.00
D	0.95	
G	1.90	
H	2.90	3.10
J	0.013	0.10
K	1.00	1.30
L	0.35	0.55
M	0.10	0.20
$\alpha$	0°	8°
All Dimensions in mm		

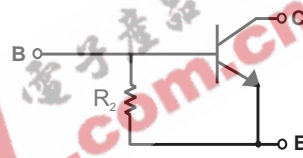

SCHMATIC DIAGRAM

P/N	R2 (NOM)	Type Code
DDTC114GKA	10K $\Omega$	N26
DDTC124GKA	22K $\Omega$	N27
DDTC144GKA	47K $\Omega$	N28
DDTC115GKA	100K $\Omega$	N29

**Maximum Ratings** @ T<sub>A</sub> = 25°C unless otherwise specified

Characteristic	Symbol	Value	Unit
Collector-Base Voltage	V <sub>CBO</sub>	50	V
Collector-Emitter Voltage	V <sub>CEO</sub>	50	V
Emitter-Base Voltage	V <sub>EBO</sub>	5	V
Collector Current	I <sub>C</sub> (Max)	100	mA
Power Dissipation	P <sub>d</sub>	200	mW
Thermal Resistance, Junction to Ambient Air (Note 1)	R <sub>θJA</sub>	625	°C/W
Operating and Storage and Temperature Range	T <sub>j</sub> , T <sub>STG</sub>	-55 to +150	°C

- Note:
1. Mounted on FR4 PC Board with recommended pad layout at <http://www.diodes.com/datasheets/ap02001.pdf>.
  2. No purposefully added lead.
  3. Diodes Inc.'s "Green" policy can be found on our website at [http://www.diodes.com/products/lead\\_free/index.php](http://www.diodes.com/products/lead_free/index.php).
  4. Product manufactured with Date Code 0609 (week 9, 2006) and newer are built with Green Molding Compound. Product manufactured prior to Date Code 0609 are built with Non-Green Molding Compound and may contain Halogens or Sb2O3 Fire Retardants.

**Electrical Characteristics** @ T<sub>A</sub> = 25°C unless otherwise specified

Characteristic		Symbol	Min	Typ	Max	Unit	Test Condition
Collector-Base Breakdown Voltage		BV <sub>CBO</sub>	50	—	—	V	I <sub>C</sub> = 50μA
Collector-Emitter Breakdown Voltage		BV <sub>CEO</sub>	50	—	—	V	I <sub>C</sub> = 1mA
Emitter-Base Breakdown Voltage		BV <sub>EBO</sub>	5	—	—	V	I <sub>E</sub> = 720μA, DDTC114GKA I <sub>E</sub> = 330μA, DDTC124GKA I <sub>E</sub> = 160μA, DDTC144GKA I <sub>E</sub> = 72μA, DDTC115GKA
Collector Cutoff Current		I <sub>CBO</sub>	—	—	0.5	μA	V <sub>CB</sub> = 50V
Emitter Cutoff Current	DDTC114GKA	I <sub>EBO</sub>	300	—	580	μA	V <sub>EB</sub> = 4V
	DDTC124GKA		140		260		
	DDTC144GKA		65		130		
	DDTC115GKA		30		58		
Collector-Emitter Saturation Voltage		V <sub>CE(sat)</sub>	—	—	0.3	V	I <sub>C</sub> = 10mA, I <sub>B</sub> = 0.5mA
DC Current Transfer Ratio	DDTC114GKA	h <sub>FE</sub>	30	—	—	—	I <sub>C</sub> = 5mA, V <sub>CE</sub> = 5V
	DDTC124GKA		56				
	DDTC144GKA		68				
	DDTC115GKA		82				
Bleeder Resistor (R <sub>2</sub> ) Tolerance		ΔR <sub>2</sub>	-30	—	+30	%	—
Gain-Bandwidth Product*		f <sub>T</sub>	—	250	—	MHz	V <sub>CE</sub> = 10V, I <sub>E</sub> = -5mA, f = 100MHz

\* Transistor - For Reference Only

**Ordering Information** (Note 4 & 5)

Device	Packaging	Shipping
DDTC114GKA-7-F	SC-59	3000/Tape & Reel
DDTC124GKA-7-F	SC-59	3000/Tape & Reel
DDTC144GKA-7-F	SC-59	3000/Tape & Reel
DDTC115GKA-7-F	SC-59	3000/Tape & Reel

- Notes: 4. Product manufactured with Date Code 0609 (week 9, 2006) and newer are built with Green Molding Compound. Product manufactured prior Date Code 0609 are built with Non-Green Molding Compound and may contain Halogens or Sb<sub>2</sub>O<sub>3</sub> Fire Retardants.  
5. For Packaging Details, go to our website at <http://www.diodes.com/datasheets/ap02007.pdf>.

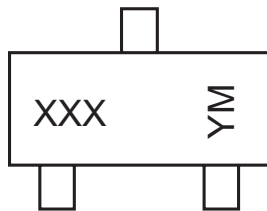
**Marking Information**

XXX = Product Type Marking Code, See Table on Page 1  
 YM = Date Code Marking  
 Y = Year ex: N = 2002  
 M = Month ex: 9 = September

Date Code Key

Year	2002	2003	2004	2005	2006	2007	2008	2009
Code	N	P	R	S	T	U	V	W

Month	Jan	Feb	March	Apr	May	Jun	Jul	Aug	Sep	Oct	Nov	Dec
Code	1	2	3	4	5	6	7	8	9	O	N	D

**TYPICAL CURVES - DDTC114GKA**

NEW PRODUCT

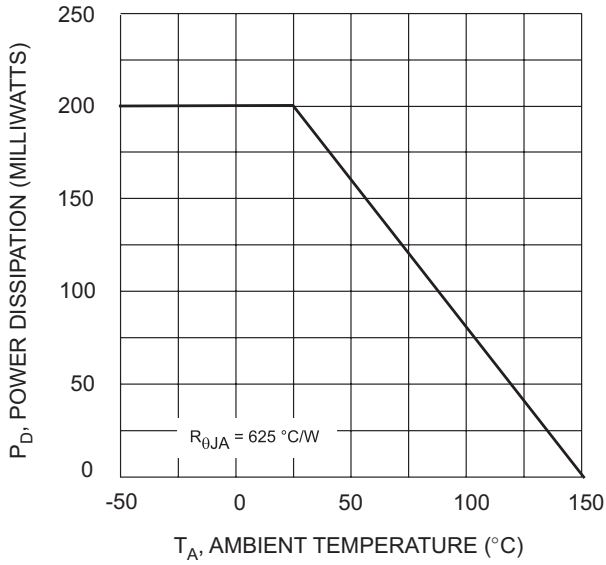

Fig. 1 Derating Curve

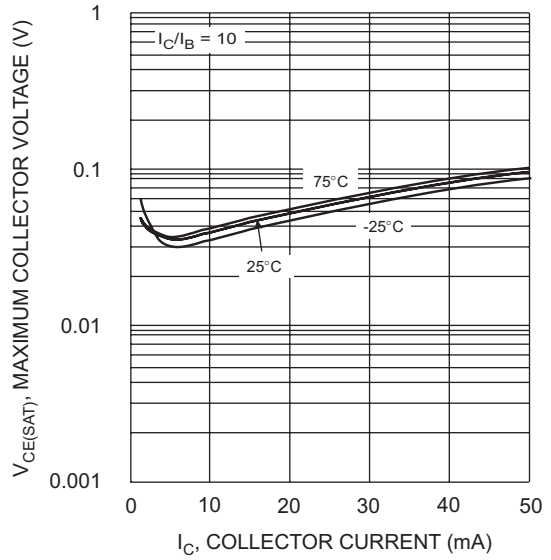

Fig. 2  $V_{CE(SAT)}$  vs.  $I_C$

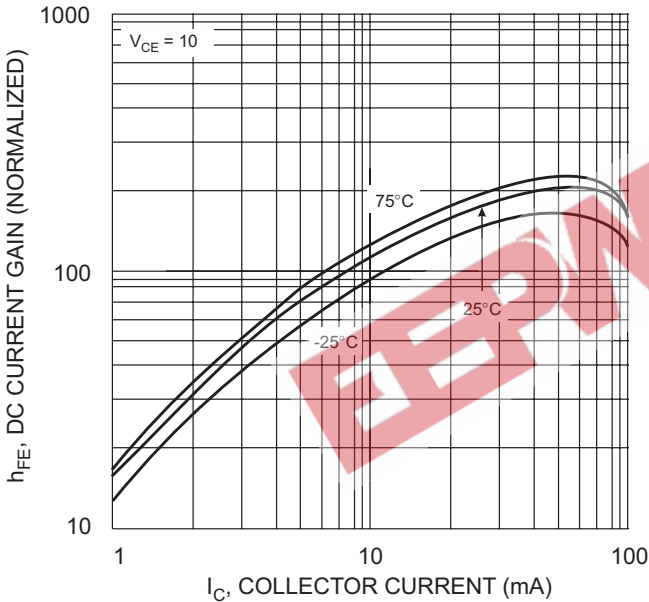

Fig. 3 DC CURRENT GAIN

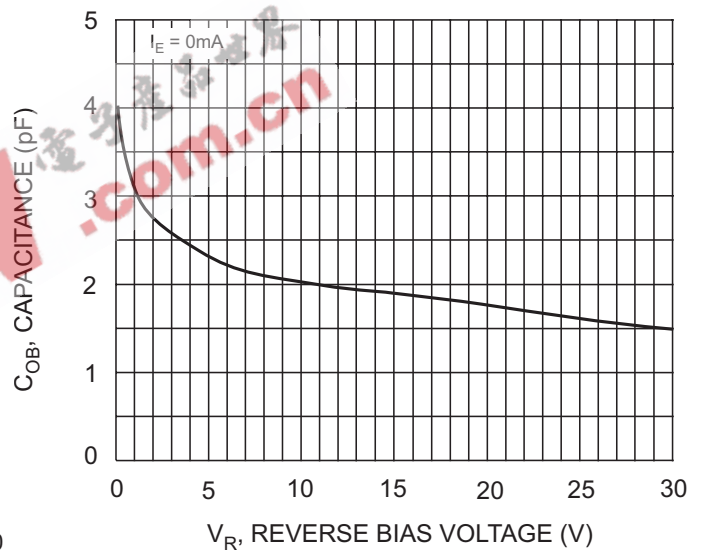

Fig. 4 Output Capacitance

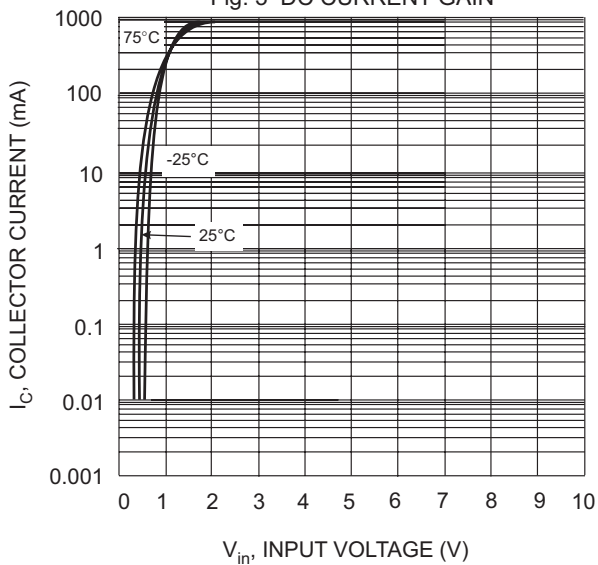

Fig. 5 Collector Current Vs. Input Voltage

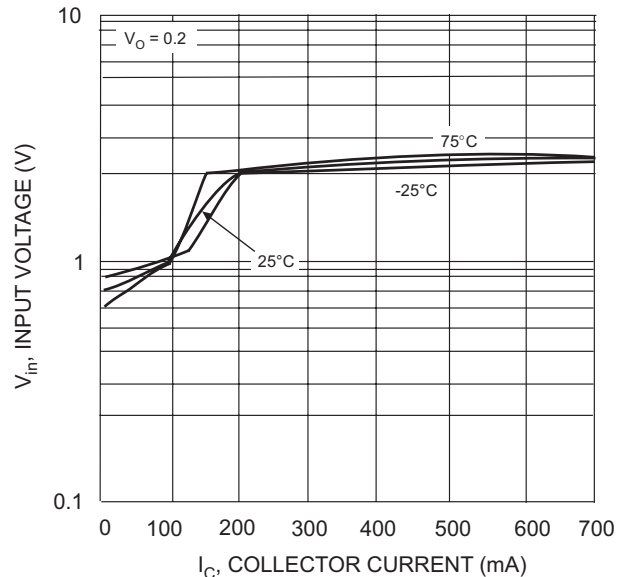

Fig. 6 Input Voltage vs. Collector Current

**IMPORTANT NOTICE**

Diodes, Inc. and its subsidiaries reserve the right to make changes without further notice to any product herein to make corrections, modifications, enhancements, improvements, or other changes. Diodes, Inc. does not assume any liability arising out of the application or use of any product described herein; neither does it convey any license under its patent rights, nor the rights of others. The user of products in such applications shall assume all risks of such use and will agree to hold Diodes Incorporated and all the companies whose products are represented on our website, harmless against all damages.

**LIFE SUPPORT**

The products located on our website at [www.diodes.com](http://www.diodes.com) are not recommended for use in life support systems where a failure or malfunction of the component may directly threaten life or cause injury without the expressed written approval of Diodes Incorporated.

EEPW 电子產品世界  
.com.cn