

DDTA (R2-ONLY SERIES) UA

PNP PRE-BIASED SMALL SIGNAL SOT-323
SURFACE MOUNT TRANSISTOR

NEW PRODUCT

Features

- Epitaxial Planar Die Construction
- Complementary NPN Types Available (DDTC)
- Built-In Biasing Resistor, R2 only
- Lead Free/RoHS Compliant (Note 2)**
- "Green" Device, Note 3 and 4**

Mechanical Data

- Case: SOT-323
- Case Material: Molded Plastic, "Green" Molding Compound, Note 4. UL Flammability Classification Rating 94V-0
- Moisture Sensitivity: Level 1 per J-STD-020C
- Terminal Connections: See Diagram
- Terminals: Solderable per MIL-STD-202, Method 208
- Lead Free Plating (Matte Tin Finish annealed over Alloy 42 leadframe).
- Marking: Date Code and Type Code, See Page 2
- Type Code: See Table Below
- Ordering Information (See Page 2)
- Weight: 0.006 grams (approximate)

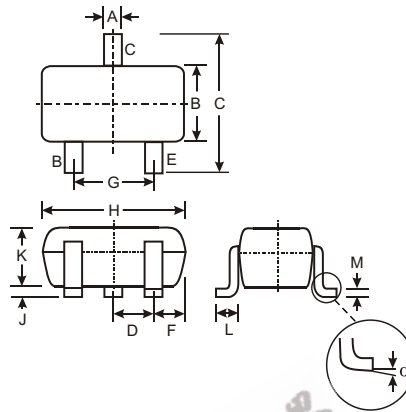

SOT-323		
Dim	Min	Max
A	0.25	0.40
B	1.15	1.35
C	2.00	2.20
D	0.65 Nominal	
E	0.30	0.40
G	1.20	1.40
H	1.80	2.20
J	0.0	0.10
K	0.90	1.00
L	0.25	0.40
M	0.10	0.18
	0	8
All Dimensions in mm		

P/N	R2 (NOM)	Type Code
DDTA114GUA	10K	P26
DDTA124GUA	22K	P27
DDTA144GUA	47K	P28
DDTA115GUA	100K	P29

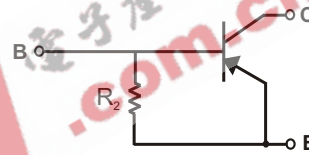

SCHEMATIC DIAGRAM

Maximum Ratings @ T_A = 25 C unless otherwise specified

Characteristic	Symbol	Value	Unit
Collector-Base Voltage	V _{CBO}	-50	V
Collector-Emitter Voltage	V _{CEO}	-50	V
Emitter-Base Voltage	V _{EBO}	-5	V
Collector Current	I _C (Max)	-100	mA
Power Dissipation	P _d	200	mW
Thermal Resistance, Junction to Ambient Air (Note 1)	R _{JA}	625	C/W
Operating and Storage and Temperature Range	T _j , T _{STG}	-55 to +150	C

- Note:
- Mounted on FR4 PC Board with recommended pad layout at <http://www.diodes.com/datasheets/ap02001.pdf>.
 - No purposefully added lead.
 - Diodes Inc.'s "Green" Policy can be found on our website at http://www.diodes.com/products/lead_free/index.php.
 - Product manufactured with date code 0609 (week 9, 2006) and newer are built with Green Molding Compound. Product manufactured prior to date code 0609 are built with Non-Green Molding Compound and may contain Halogens or Sb₂O₃ Fire Retardants.

Electrical Characteristics @ T_A = 25 C unless otherwise specified

Characteristic		Symbol	Min	Typ	Max	Unit	Test Condition
Collector-Base Breakdown Voltage		BV _{CBO}	-50			V	I _C = -50 A
Collector-Emitter Breakdown Voltage		BV _{CEO}	-50			V	I _C = -1mA
Emitter-Base Breakdown Voltage		BV _{EBO}	5			V	I _E = -720 A, DDTA114GUA I _E = -330 A, DDTA124GUA I _E = -160 A, DDTA144GUA I _E = -72 A, DDTA115GUA
Collector Cutoff Current		I _{CBO}			-0.5	A	V _{CB} = -50V
Emitter Cutoff Current	DDTA114GUA DDTA124GUA DDTA144GUA DDTA115GUA	I _{EBO}	-300 -140 -65 -30		-580 -260 -130 -58	A	V _{EB} = -4V
Collector-Emitter Saturation Voltage		V _{CE(sat)}			-0.3	V	I _C = -10mA, I _B = -0.5mA
DC Current Transfer Ratio	DDTA114GUA DDTA124GUA DDTA144GUA DDTA115GUA	h _{FE}	30 56 68 82				I _C = -5mA, V _{CE} = -5V
Bleeder Resistor (R ₂) Tolerance		R ₂	-30		+30	%	
Gain-Bandwidth Product*		f _T		250		MHz	V _{CE} = -10V, I _E = 5mA, f = 100MHz

* Transistor - For Reference Only

Ordering Information (Note 4 & 5)

Device	Packaging	Shipping
DDTA114GUA-7-F	SOT-323	3000/Tape & Reel
DDTA124GUA-7-F	SOT-323	3000/Tape & Reel
DDTA144GUA-7-F	SOT-323	3000/Tape & Reel
DDTA115GUA-7-F	SOT-323	3000/Tape & Reel

- Notes: 4. Product manufactured with date code 0609 (week 9, 2006) and newer are built with Green Molding Compound. Product manufactured prior to date code 0609 are built with Non-Green Molding Compound and may contain Halogens or Sb2O3 Fire Retardants.
5. For Packaging Details, go to our website at <http://www.diodes.com/datasheets/ap02007.pdf>.

Marking Information

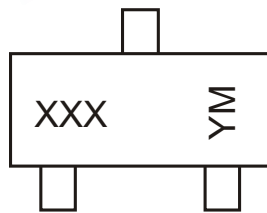

XXX = Product Type Marking Code, See Table on Page 1
YM = Date Code Marking
Y = Year ex: N = 2002
M = Month ex: 9 = September

Date Code Key

Year	2002	2003	2004	2005	2006	2007	2008	2009
Code	N	P	R	S	T	U	V	W

Month	Jan	Feb	March	Apr	May	Jun	Jul	Aug	Sep	Oct	Nov	Dec
Code	1	2	3	4	5	6	7	8	9	O	N	D

TYPICAL CURVES - DDTA114GUA

NEW PRODUCT

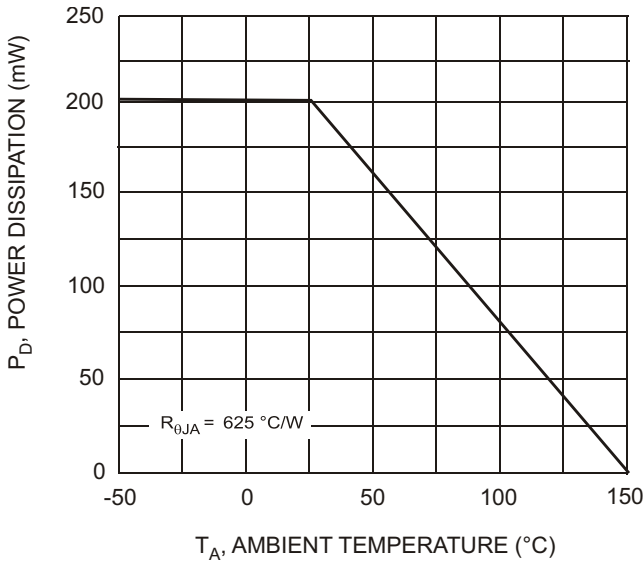

Fig. 1, Derating Curve

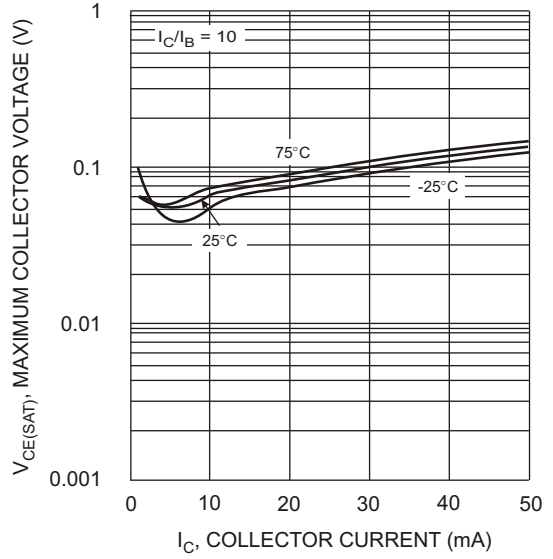

Fig. 2 $V_{CE(SAT)}$ vs. I_C

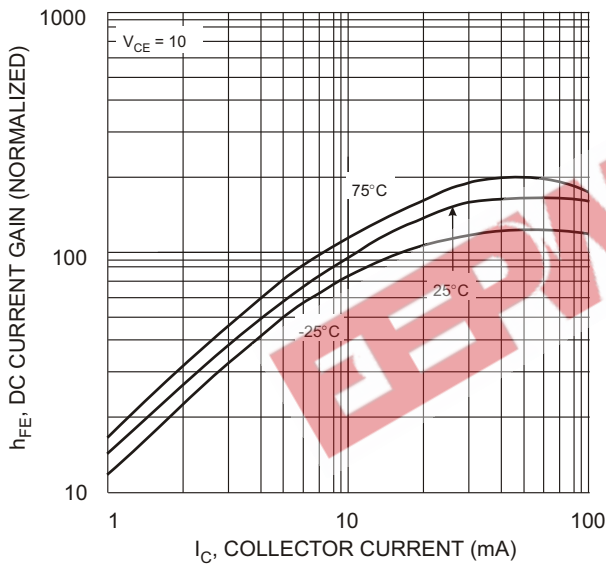

Fig. 3 DC CURRENT GAIN

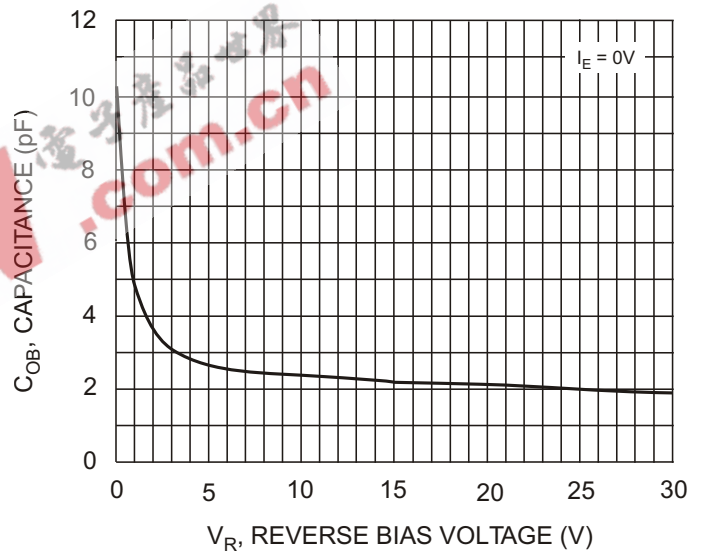

Fig. 4 Output Capacitance

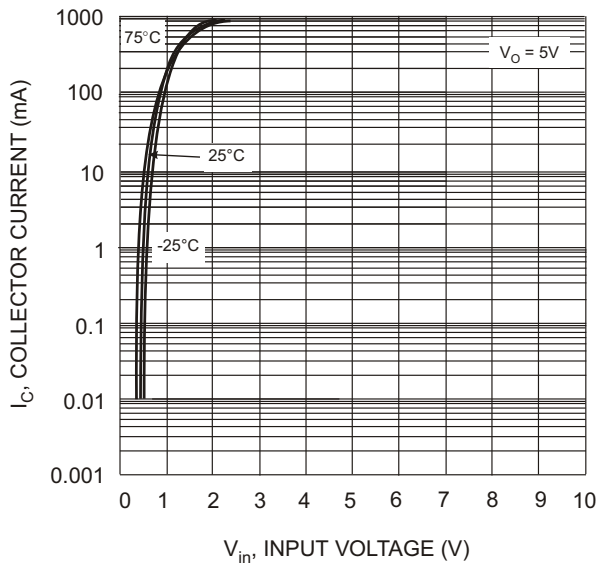

Fig. 5 Collector Current Vs. Input Voltage

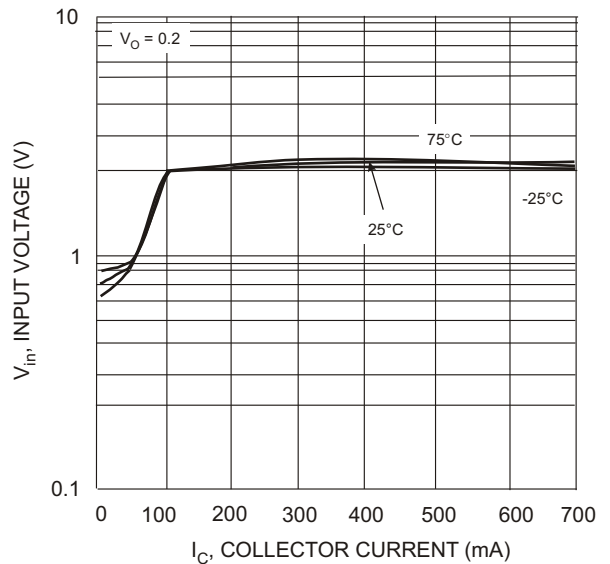

Fig. 6 Input Voltage vs. Collector Current

IMPORTANT NOTICE

Diodes, Inc. and its subsidiaries reserve the right to make changes without further notice to any product herein to make corrections, modifications, enhancements, improvements, or other changes. Diodes, Inc. does not assume any liability arising out of the application or use of any product described herein; neither does it convey any license under its patent rights, nor the rights of others. The user of products in such applications shall assume all risks of such use and will agree to hold Diodes Incorporated and all the companies whose products are represented on our website, harmless against all damages.

LIFE SUPPORT

The products located on our website at www.diodes.com are not recommended for use in life support systems where a failure or malfunction of the component may directly threaten life or cause injury without the expressed written approval of Diodes Incorporated.

EEPW 电子產品世界
.com.cn