

### Features

- Epitaxial Planar Die Construction
- Ultra-Small Leadless Surface Mount Package
- Ideally Suited for Automated Assembly Processes
- **Lead Free By Design/RoHS Compliant (Note 1)**
- **"Green" Device (Note 2)**

### Mechanical Data

- Case: DFN1006-3
- Case Material: Molded Plastic, "Green" Molding Compound. UL Flammability Classification Rating 94V-0
- Moisture Sensitivity: Level 1 per J-STD-020C
- Terminal Connections: Collector Dot (See Diagram)
- Terminals: Finish — NiPdAu annealed over Copper leadframe. Solderable per MIL-STD-202, Method 208
- Marking Information: See Page 6
- Ordering Information: See Page 6
- Weight: 0.001 grams (approximate)

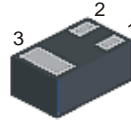

Fig. 1

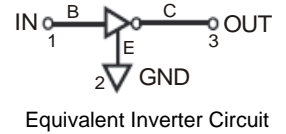
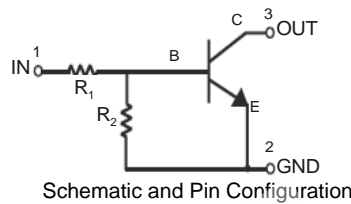
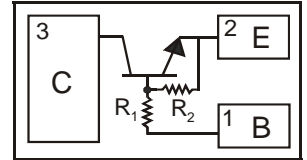

Fig. 2

Component P/N	R1(NOM)	R2(NOM)	Figure
DDTC123JLP	2.2K	47K	2
DDTC143ZLP	4.7K	47K	2
DDTC114YLP	10K	47K	2

### Maximum Ratings @<sub>TA</sub> = 25°C unless otherwise specified

Characteristic	P/N	Symbol	Value	Unit
Supply Voltage		V <sub>CC</sub>	50	V
Input Voltage	DDTC123JLP	V <sub>IN</sub>	-5 to +12	V
	DDTC143ZLP		-5 to +30	
	DDTC114YLP		-5 to +40	
Output Voltage	DDTC123JLP	I <sub>O</sub>	100	mA
	DDTC143ZLP		100	
	DDTC114YLP		70	
Power Dissipation (Note 3)		P <sub>D</sub>	250	mW
Power Deration above 25 °C		P <sub>der</sub>	2	mW/°C
Maximum Collector Current		I <sub>C(max)</sub>	100	mA

### Thermal Characteristics

Characteristic	Symbol	Value	Unit
Junction Operating and Storage Temperature Range	T <sub>j</sub> , T <sub>STG</sub>	-55 to +150	°C
Thermal Resistance, Junction to Ambient Air (Note 3) (Equivalent to one heated junction of NPN)	R <sub>θJA</sub>	400	°C/W

- Notes:
1. No purposefully added lead.
  2. Diodes Inc.'s "Green" policy can be found on our website at [http://www.diodes.com/products/lead\\_free/index.php](http://www.diodes.com/products/lead_free/index.php).
  3. Device mounted on FR-4 PCB, 1 inchx0.85inchx0.062inch; pad layout as shown on Diodes Inc. suggested pad layout document AP02001, which can be found on page 6 or our website at <http://www.diodes.com/datasheets/ap02001.pdf>.



## Electrical Characteristics @T<sub>A</sub> = 25°C unless otherwise specified

Characteristic	P/N	Symbol	Min	Typ	Max	Unit	Test Condition
<b>Off Characteristics</b> (Note 4)							
Collector-Base Breakdown Voltage		V <sub>(BR)CBO</sub>	50	—	—	V	I <sub>C</sub> = 10μA, I <sub>E</sub> = 0
Collector-Emitter Breakdown Voltage *		V <sub>(BR)CEO</sub>	50	—	—	V	I <sub>C</sub> = 2mA, I <sub>B</sub> = 0
Emitter-Base Breakdown Voltage *		V <sub>(BR)EBO</sub>	4.5	—	—	V	I <sub>E</sub> = 50μA, I <sub>C</sub> = 0
Collector Cutoff Current *		I <sub>CEX</sub>	—	—	0.5	μA	V <sub>CE</sub> = 50V, V <sub>EB(OFF)</sub> = 3.0V
Base Cutoff Current (I <sub>BEX</sub> )		I <sub>BL</sub>	—	—	0.5	μA	V <sub>CE</sub> = 50V, V <sub>EB(OFF)</sub> = 3.0V
Collector-Base Cut Off Current		I <sub>CBO</sub>	—	—	0.5	μA	V <sub>CB</sub> = 50V, I <sub>E</sub> = 0
Collector-Emitter Cut Off Current, I <sub>O(OFF)</sub>		I <sub>CEO</sub>	—	—	0.5	μA	V <sub>CE</sub> = 50V, I <sub>B</sub> = 0
Emitter-Base Cut Off Current		I <sub>EBO</sub>	—	—	0.5	mA	V <sub>EB</sub> = 5V, I <sub>C</sub> = 0
Input-Off Voltage		V <sub>I(OFF)</sub>	—	—	0.5	V	V <sub>CE</sub> = 5V, I <sub>C</sub> = 100μA
<b>On Characteristics</b> (Note 4)							
Base-Emitter Turn-On Voltage*	DDTC123JLP	V <sub>BE(ON)</sub>	—	—	0.85	V	V <sub>CE</sub> = 5V, I <sub>C</sub> = 2mA
	DDTC143ZLP		—	—	0.85		
	DDTC114YLP		—	—	0.95		
Base-Emitter Saturation Voltage*	DDTC123JLP	V <sub>BE(SAT)</sub>	—	—	0.98	V	I <sub>C</sub> = 10mA, I <sub>B</sub> = 1mA, V <sub>CE</sub> =5V
	DDTC143ZLP		—	—	0.998		
	DDTC114YLP		—	—	0.98		
Input-On Voltage		V <sub>I(ON)</sub>	1.1	—	—	V	V <sub>O</sub> = 0.3V, I <sub>C</sub> = 5mA
Input Current	DDTC123JLP	I <sub>I</sub>	—	—	7.2	mA	V <sub>I</sub> = 5V
	DDTC143ZLP		—	—	1.5		
	DDTC114YLP		—	—	7.2		
DC Current Gain		h <sub>FE</sub>	50	—	—	—	V <sub>CE</sub> = 5V, I <sub>C</sub> = 1mA
			70	—	—	—	V <sub>CE</sub> = 5V, I <sub>C</sub> = 2mA
			125	—	—	—	V <sub>CE</sub> = 5V, I <sub>C</sub> = 5mA
			150	—	—	—	V <sub>CE</sub> = 5V, I <sub>C</sub> = 10mA
			180	—	—	—	V <sub>CE</sub> = 5V, I <sub>C</sub> = 50mA
Collector-Emitter Saturation Voltage		V <sub>CE(SAT)</sub>	—	—	0.15	V	I <sub>C</sub> = 10mA, I <sub>B</sub> = 1mA
			—	—	0.2	V	I <sub>C</sub> = 50mA, I <sub>B</sub> = 5mA
Output On Voltage (Same as V <sub>CE(SAT)</sub> )		V <sub>O(ON)</sub>	—	—	0.3		I <sub>J</sub> = 2.5mA, I <sub>O</sub> = 50mA
Input Resistor +/-30%		ΔR <sub>1</sub>	-30	—	30	%	—
Resistor Ratio		Δ(R <sub>2</sub> /R <sub>1</sub> )	-20	—	-20	%	—
<b>Small Signal Characteristics</b>							
Transition Frequency (gain bandwidth product)		F <sub>t</sub>	—	250	—	MHz	V <sub>CE</sub> = 10V, I <sub>E</sub> = 5mA, f = 100MHz

\*Guaranteed by design

- Notes: 4. Short duration pulse test used to minimize self-heating effect.  
Pulse Test: Pulse width, t<sub>p</sub><300 uS, Duty Cycle, d<=0.02

## Typical Characteristics Curves @T<sub>A</sub> = 25°C unless otherwise specified

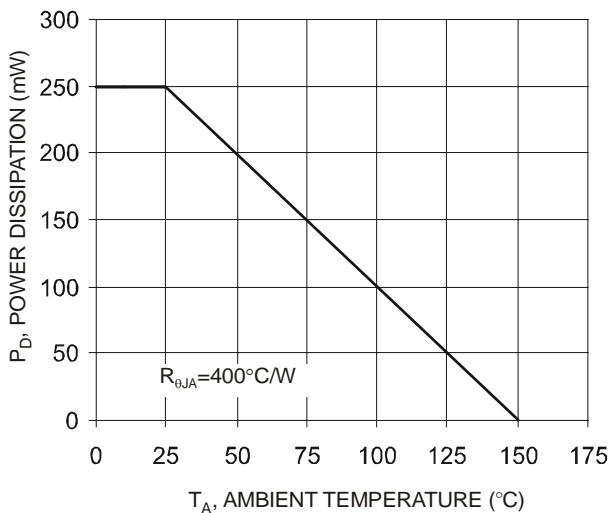

Fig. 3 Power Derating Curve

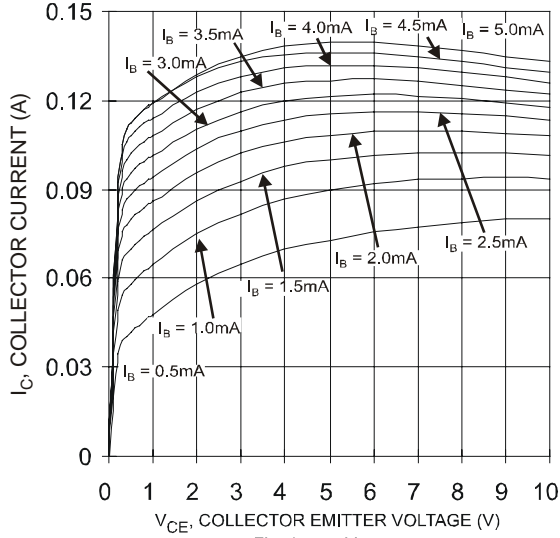

Fig. 4 I<sub>C</sub> vs V<sub>CE</sub>

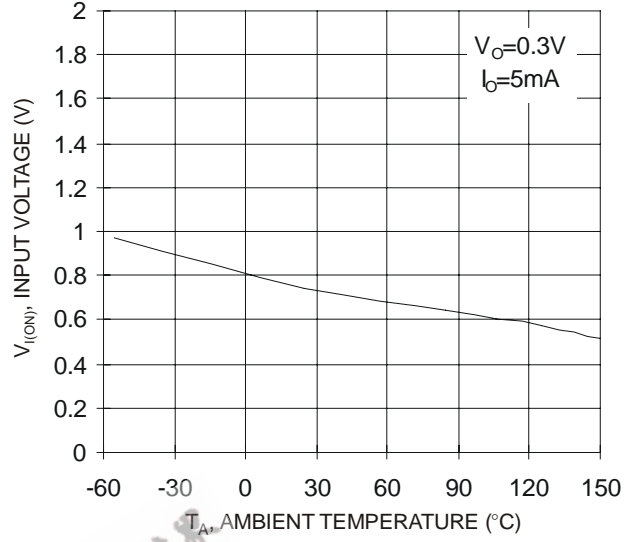

Fig. 5 Input Voltage vs. T<sub>A</sub>

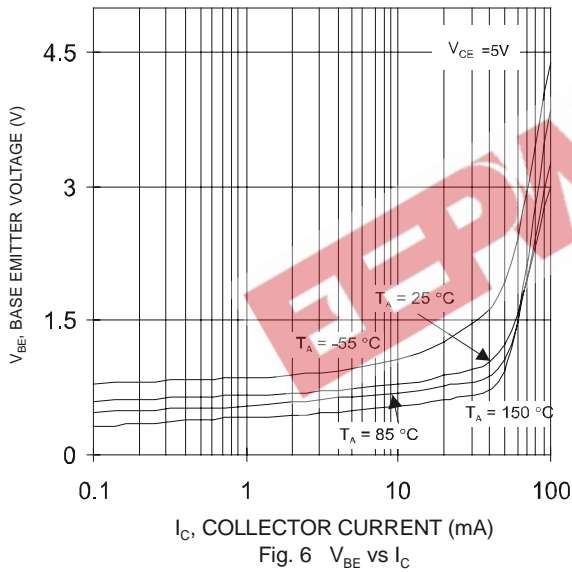

Fig. 6 V<sub>BE</sub> vs I<sub>C</sub>

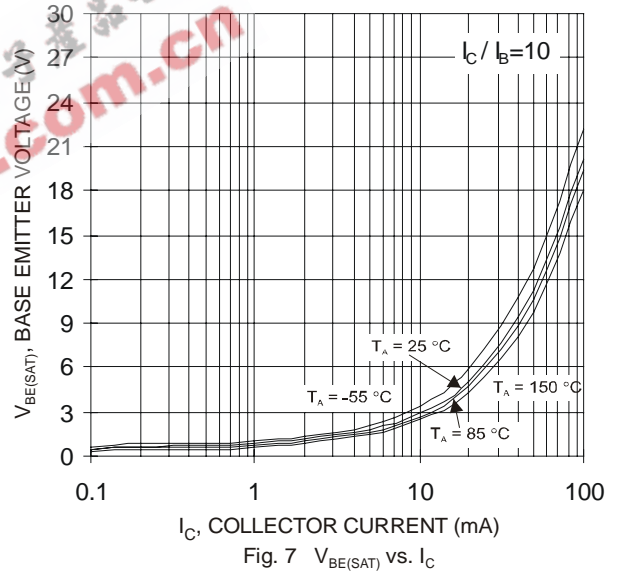

Fig. 7 V<sub>BE(SAT)</sub> vs. I<sub>C</sub>

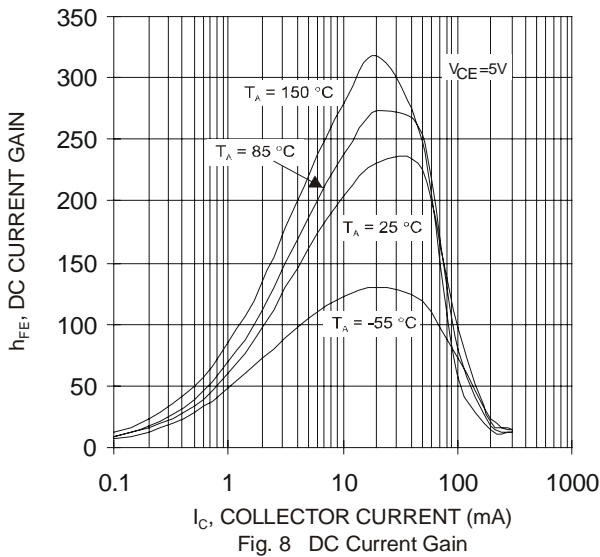

Fig. 8 DC Current Gain

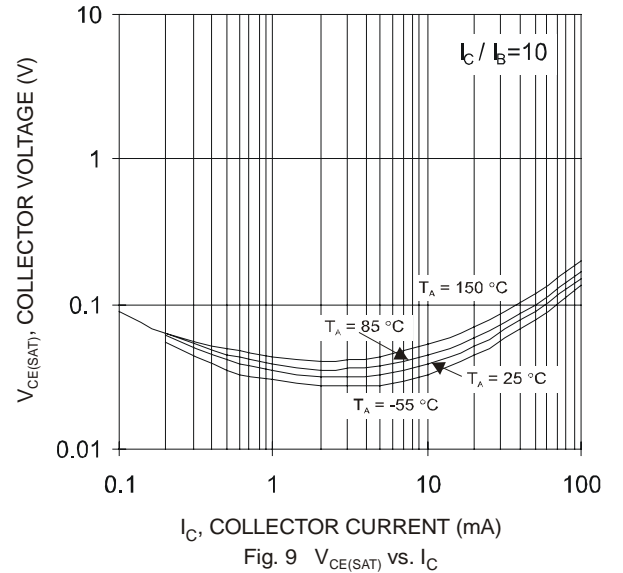

Fig. 9 V<sub>CE(SAT)</sub> vs. I<sub>C</sub>

**Characteristics Curves of DDTC143ZLP** @ $T_A = 25^\circ\text{C}$  unless otherwise specified

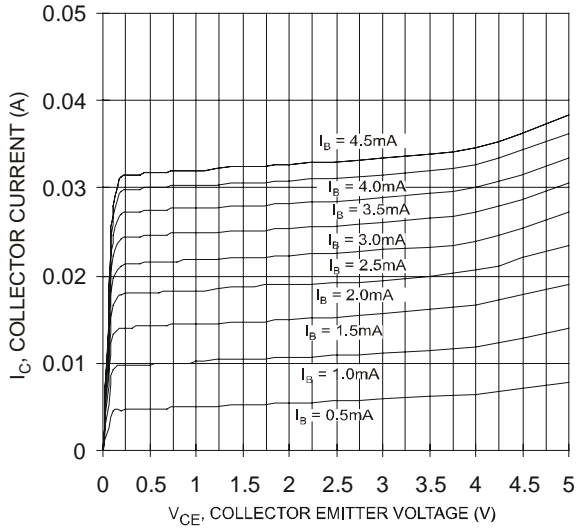

Fig. 10  $I_C$  vs  $V_{CE}$

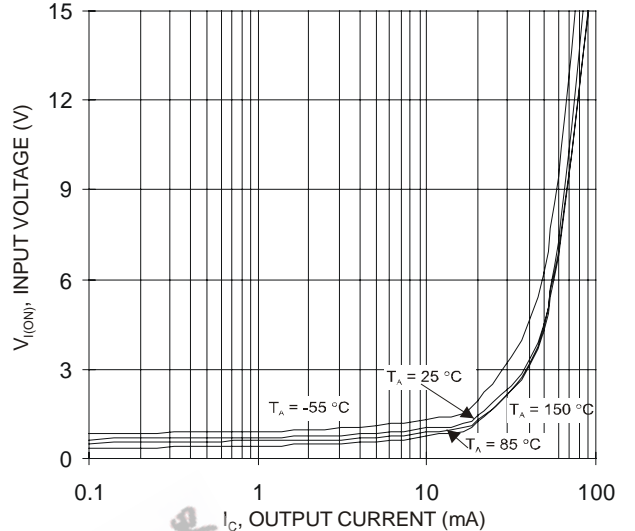

Fig. 11 Input Voltage vs. Output Current

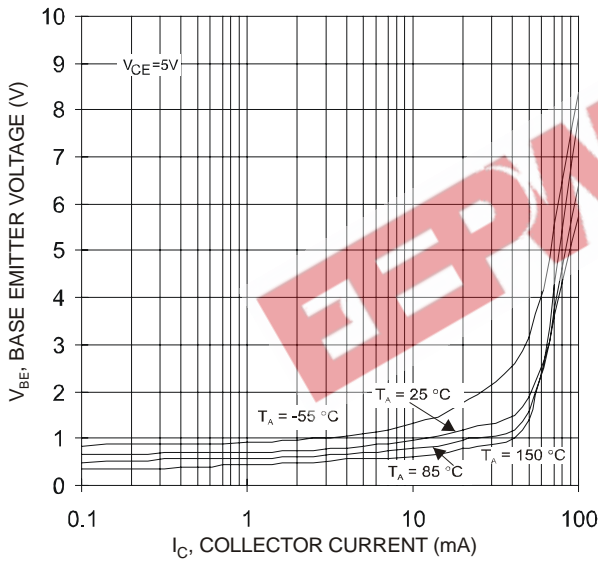

Fig. 12  $V_{BE}$  vs.  $I_C$

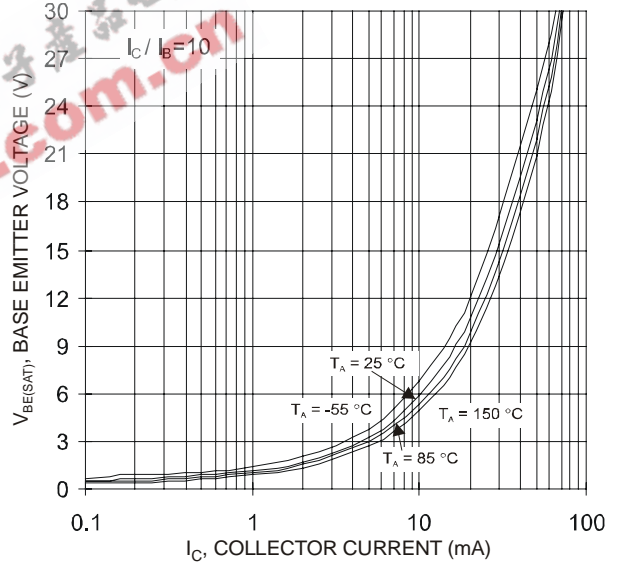

Fig. 13  $V_{BE(SAT)}$  vs.  $I_C$

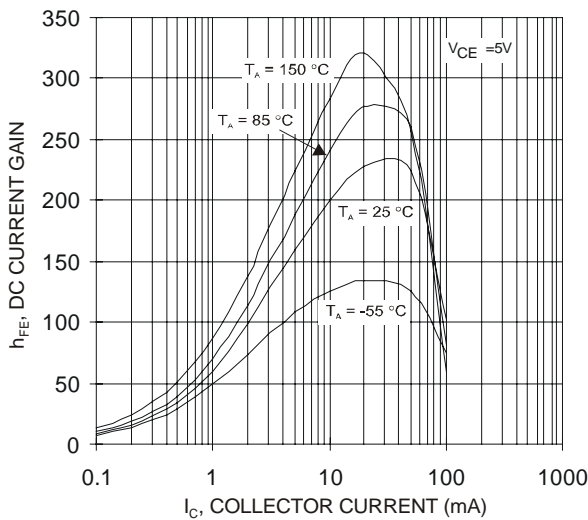

Fig. 14 DC Current Gain

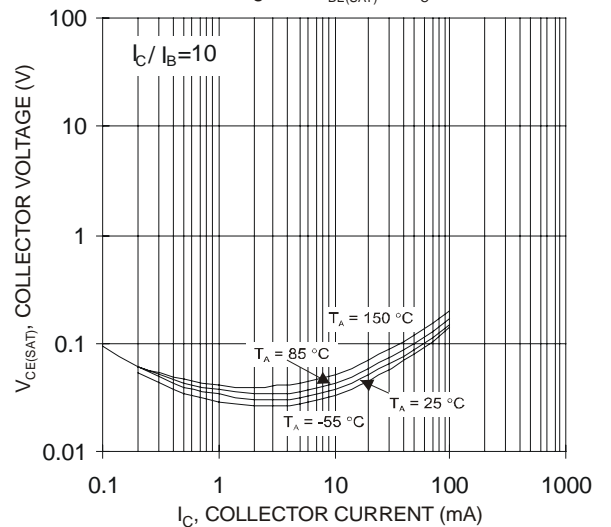

Fig. 15  $V_{CE(SAT)}$  vs.  $I_C$

**Characteristics Curves of DDTC114YLP**

@ $T_A = 25^\circ\text{C}$  unless otherwise specified

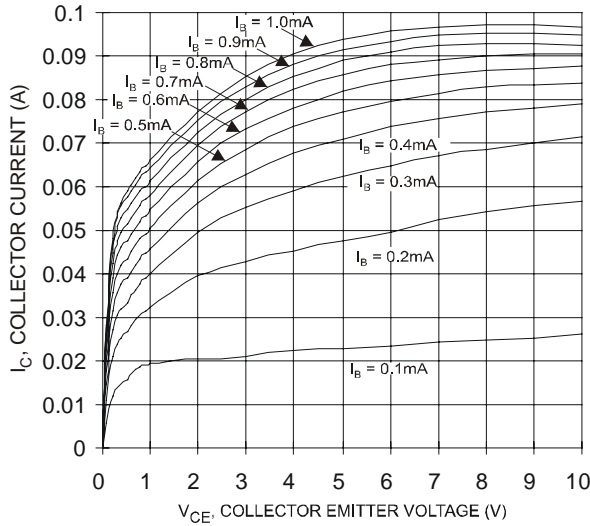

Fig. 16  $I_C$  vs  $V_{CE}$

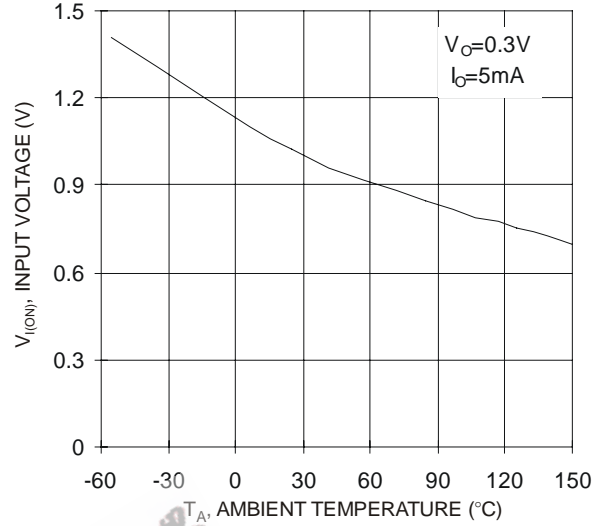

Fig. 17 Input Voltage vs.  $T_A$

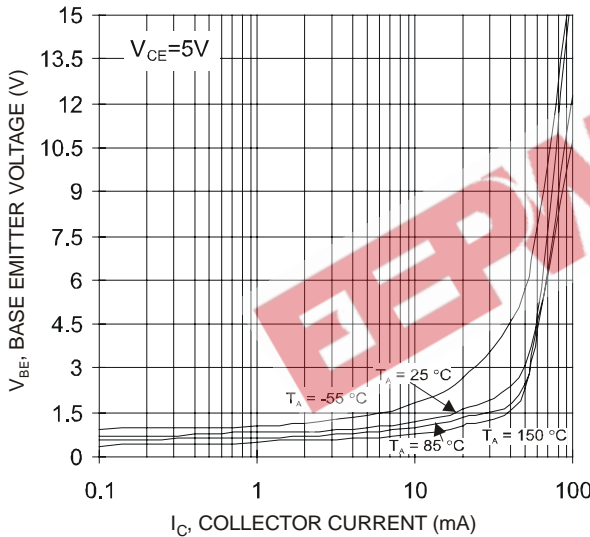

Fig. 18  $V_{BE}$  vs.  $I_C$

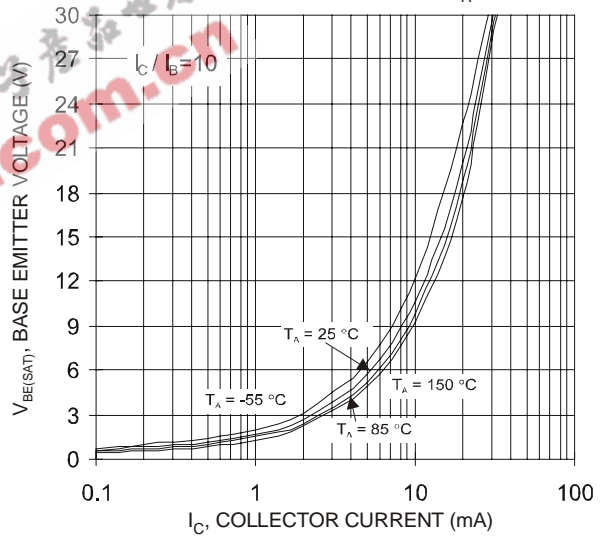

Fig. 19  $V_{BE(SAT)}$  vs.  $I_C$

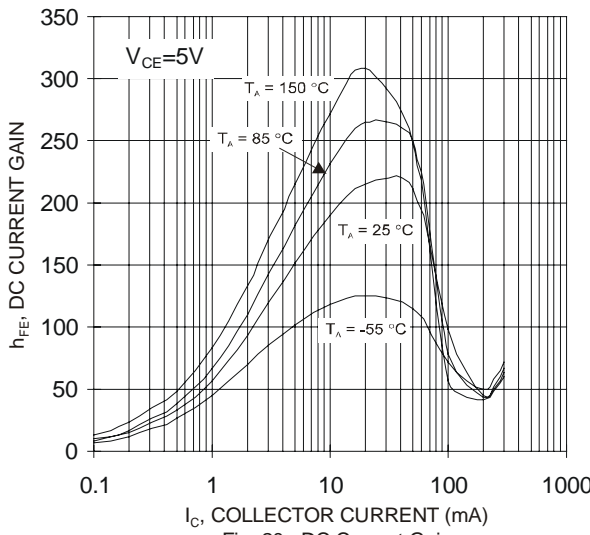

Fig. 20 DC Current Gain

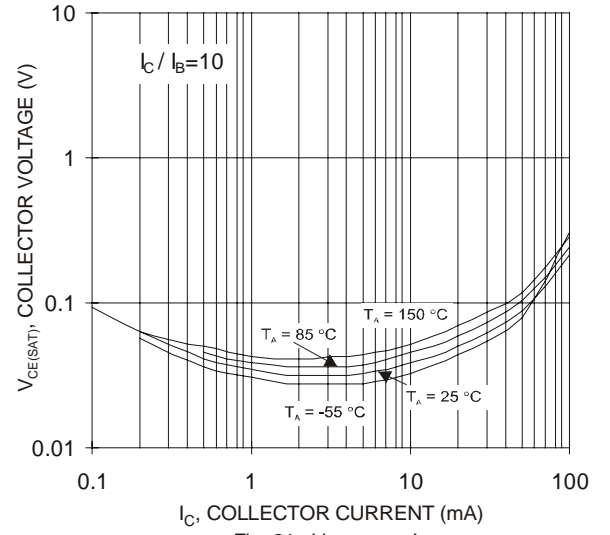

Fig. 21  $V_{CE(SAT)}$  vs.  $I_C$

## Ordering Information (Note 5)

Device	Marking Code	Packaging	Shipping
DDTC123JLP-7-F	N0	DFN1006-3	3000/Tape & Reel
DDTC143ZLP-7-F	N1	DFN1006-3	3000/Tape & Reel
DDTC114YLP-7-F	N2	DFN1006-3	3000/Tape & Reel

Notes: 5. For Packaging Details, please see below or go to our website at <http://www.diodes.com/datasheets/ap02007.pdf>.

## Marking Information

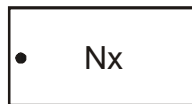

Nx = Product Type Marking Code, see ordering information above  
 YM = Date Code Marking  
 Y = Year e.g. U = 2007  
 M = Month e.g. 9 = September

Fig. 22

### Date Code Key

Year	2007	2008	2009	2010	2011	2012
Code	U	V	W	X	Y	Z

Month	Jan	Feb	Mar	Apr	May	Jun	Jul	Aug	Sep	Oct	Nov	Dec
Code	1	2	3	4	5	6	7	8	9	O	N	D

## Mechanical Details

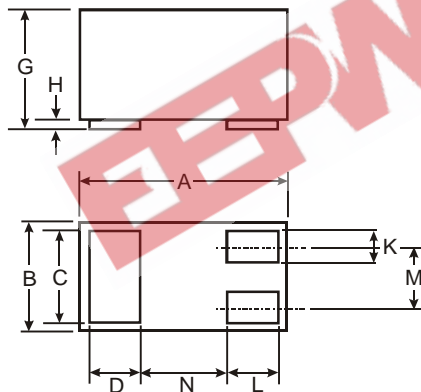

Fig. 23

DFN1006-3			
Dim	Min	Max	Typ
A	0.95	1.075	1.00
B	0.55	0.675	0.60
C	0.45	0.55	0.50
D	0.20	0.30	0.25
G	0.47	0.53	0.50
H	0	0.05	0.03
K	0.10	0.20	0.15
L	0.20	0.30	0.25
M	—	—	0.35
N	—	—	0.40
All Dimensions in mm			

## Suggested Pad Layout: (Based on IPC-SM-782)

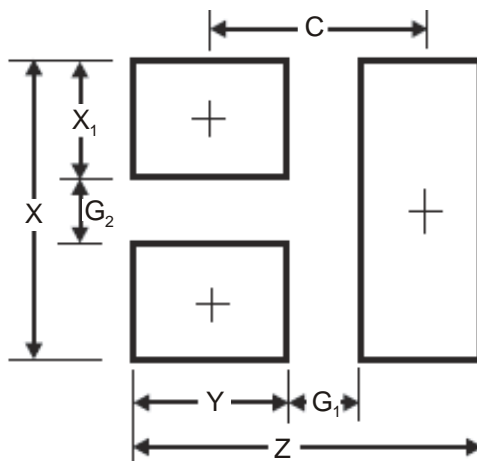

Fig. 24

DFN1006-3	
Z	1.1
G1	0.3
G2	0.2
X	0.7
X1	0.25
Y	0.4
C	0.7
All Dimensions in mm	



#### IMPORTANT NOTICE

Diodes Incorporated and its subsidiaries reserve the right to make modifications, enhancements, improvements, corrections or other changes without further notice to any product herein. Diodes Incorporated does not assume any liability arising out of the application or use of any product described herein; neither does it convey any license under its patent rights, nor the rights of others. The user of products in such applications shall assume all risks of such use and will agree to hold Diodes Incorporated and all the companies whose products are represented on our website, harmless against all damages.

#### LIFE SUPPORT

Diodes Incorporated products are not authorized for use as critical components in life support devices or systems without the expressed written approval of the President of Diodes Incorporated.

EEPW 电子产品世界  
.com.cn