

FEATURES

- Double Side Cooling
- High Surge Capability
- High Mean Current
- Fatigue Free

APPLICATIONS

- High Power Drives
- High Voltage Power Supplies
- DC Motor Control

VOLTAGE RATINGS

Type Number	Repetitive Peak Voltages V_{DRM} V_{RRM}	Conditions
DCR1675SA52	5200	$T_{vj} = 0^\circ$ to 125°C , $I_{DRM} = I_{RRM} = 500\text{mA}$, $V_{DRM}, V_{RRM}, t_p = 10\text{ms}$, $V_{DSM} \text{ \& \ } V_{RSM} =$ $V_{DRM} \text{ \& \ } V_{RRM} + 100\text{V}$ respectively
DCR1675SA51	5100	
DCR1675SA50	5000	
DCR1675SA49	4900	
DCR1675SA48	4800	

Lower voltage grades available.

ORDERING INFORMATION

When ordering, select the required part number shown in the Voltage Ratings selection table.

For example:

DCR1675SA51

Note: Please use the complete part number when ordering and quote this number in any future correspondence relating to your order.

KEY PARAMETERS

V_{DRM} 5200V

$I_{T(AV)}$ 3770A

I_{TSM} 50000A

dV/dt^* 1000V/ μs

dI/dt 300A/ μs

*Higher dV/dt selections available

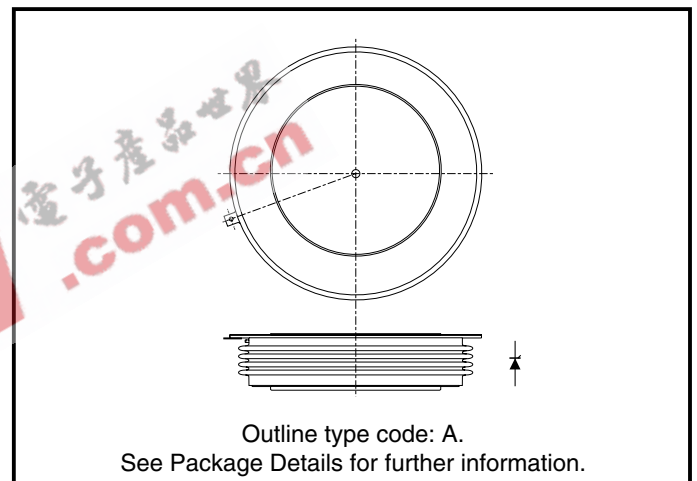

Outline type code: A.
See Package Details for further information.

Fig. 1 Package outline

CURRENT RATINGS

 $T_{\text{case}} = 60^{\circ}\text{C}$ unless stated otherwise.

Symbol	Parameter	Conditions	Max.	Units
Double Side Cooled				
$I_{T(AV)}$	Mean on-state current	Half wave resistive load	3770	A
$I_{T(RMS)}$	RMS value	-	5920	A
I_T	Continuous (direct) on-state current	-	5486	A
Single Side Cooled (Anode side)				
$I_{T(AV)}$	Mean on-state current	Half wave resistive load	2476	A
$I_{T(RMS)}$	RMS value	-	3889	A
I_T	Continuous (direct) on-state current	-	3333	A

CURRENT RATINGS

 $T_{\text{case}} = 80^{\circ}\text{C}$ unless stated otherwise.

Symbol	Parameter	Conditions	Max.	Units
Double Side Cooled				
$I_{T(AV)}$	Mean on-state current	Half wave resistive load	2975	A
$I_{T(RMS)}$	RMS value	-	4670	A
I_T	Continuous (direct) on-state current	-	4230	A
Single Side Cooled (Anode side)				
$I_{T(AV)}$	Mean on-state current	Half wave resistive load	1920	A
$I_{T(RMS)}$	RMS value	-	3015	A
I_T	Continuous (direct) on-state current	-	2510	A

SURGE RATINGS

Symbol	Parameter	Conditions	Max.	Units
I_{TSM}	Surge (non-repetitive) on-state current	10ms half sine; $T_{case} = 125^{\circ}C$	50.0	kA
I^2t	I^2t for fusing	$V_R = 50\% V_{RRM}$ - 1/4 sine	12.5×10^6	A ² s
I_{TSM}	Surge (non-repetitive) on-state current	10ms half sine; $T_{case} = 125^{\circ}C$	62.5	kA
I^2t	I^2t for fusing	$V_R = 0$	19.5×10^6	A ² s

THERMAL AND MECHANICAL DATA

Symbol	Parameter	Conditions	Min.	Max.	Units	
$R_{th(j-c)}$	Thermal resistance - junction to case	Double side cooled	dc	-	0.0065	$^{\circ}C/W$
		Single side cooled	Anode dc	-	0.013	$^{\circ}C/W$
			Cathode dc	-	0.013	$^{\circ}C/W$
$R_{th(c-h)}$	Thermal resistance - case to heatsink	Clamping force 83.0kN with mounting compound	Double side	-	0.001	$^{\circ}C/W$
			Single side	-	0.002	$^{\circ}C/W$
T_{vj}	Virtual junction temperature	On-state (conducting)		-	135	$^{\circ}C$
		Reverse (blocking)		-	125	$^{\circ}C$
T_{stg}	Storage temperature range			-55	125	$^{\circ}C$
-	Clamping force			74.0	91.0	kN

DYNAMIC CHARACTERISTICS

Symbol	Parameter	Conditions	Typ.	Max.	Units	
I_{RRM}/I_{DRM}	Peak reverse and off-state current	At V_{RRM}/V_{DRM} , $T_{case} = 125^{\circ}\text{C}$	-	500	mA	
dV/dt	Maximum linear rate of rise of off-state voltage	To 67% V_{DRM} , $T_j = 125^{\circ}\text{C}$, gate open circuit.	-	1000	V/ μs	
dI/dt	Rate of rise of on-state current	From 67% V_{DRM} to 1000A Gate source 30V, 10 Ω $t_r = 0.5\mu\text{s}$ to 1A, $T_j = 125^{\circ}\text{C}$	Repetitive 50Hz	-	150	A/ μs
			Non-repetitive	-	300	A/ μs
$V_{T(TO)}$	Threshold voltage	At $T_{vj} = 125^{\circ}\text{C}$	-	1.0	V	
r_T	On-state slope resistance	At $T_{vj} = 125^{\circ}\text{C}$	-	0.15	m Ω	
t_{gd}	Delay time	$V_D = 67\% V_{DRM}$, Gate source 20V, 10 Ω $t_r = 0.5\mu\text{s}$, $T_j = 25^{\circ}\text{C}$	-	1.1	μs	
I_L	Latching current	$T_j = 25^{\circ}\text{C}$, $V_D = 5\text{V}$	-	650	mA	
I_H	Holding current	$T_j = 25^{\circ}\text{C}$, $R_{g-k} = \infty$	-	200	mA	

GATE TRIGGER CHARACTERISTICS AND RATINGS

Symbol	Parameter	Conditions	Max.	Units
V_{GT}	Gate trigger voltage	$V_{DRM} = 5\text{V}$, $T_{case} = 25^{\circ}\text{C}$	3.5	V
I_{GT}	Gate trigger current	$V_{DRM} = 5\text{V}$, $T_{case} = 25^{\circ}\text{C}$	500	mA
V_{GD}	Gate non-trigger voltage	At V_{DRM} , $T_{case} = 125^{\circ}\text{C}$	0.25	V
V_{FGM}	Peak forward gate voltage	Anode positive with respect to cathode	30	V
V_{FGN}	Peak forward gate voltage	Anode negative with respect to cathode	0.25	V
V_{RGM}	Peak reverse gate voltage		5	V
I_{FGM}	Peak forward gate current	Anode positive with respect to cathode	30	A
P_{GM}	Peak gate power	See table, gate characteristics curve	150	W
$P_{G(AV)}$	Mean gate power		10	W

CURVES

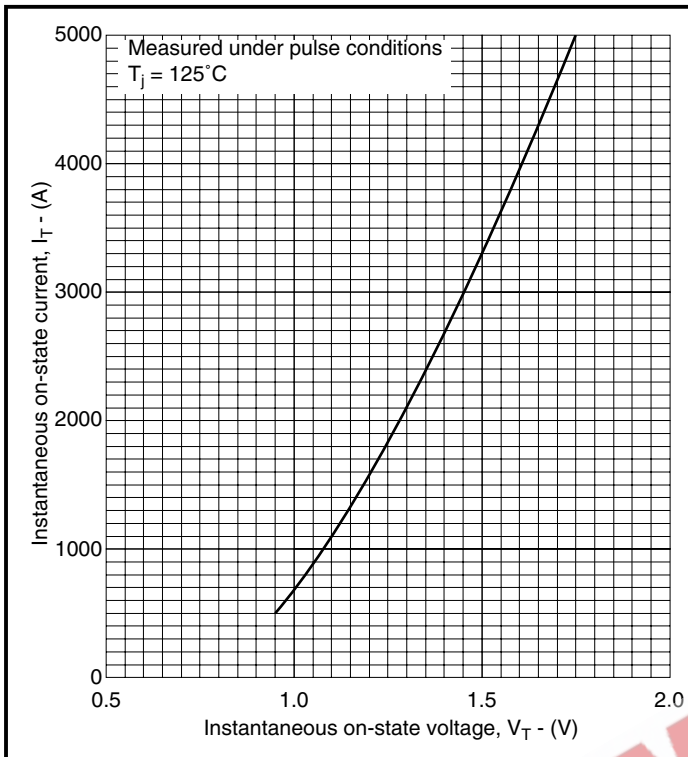

Fig.2 Maximum (limit) on-state characteristics

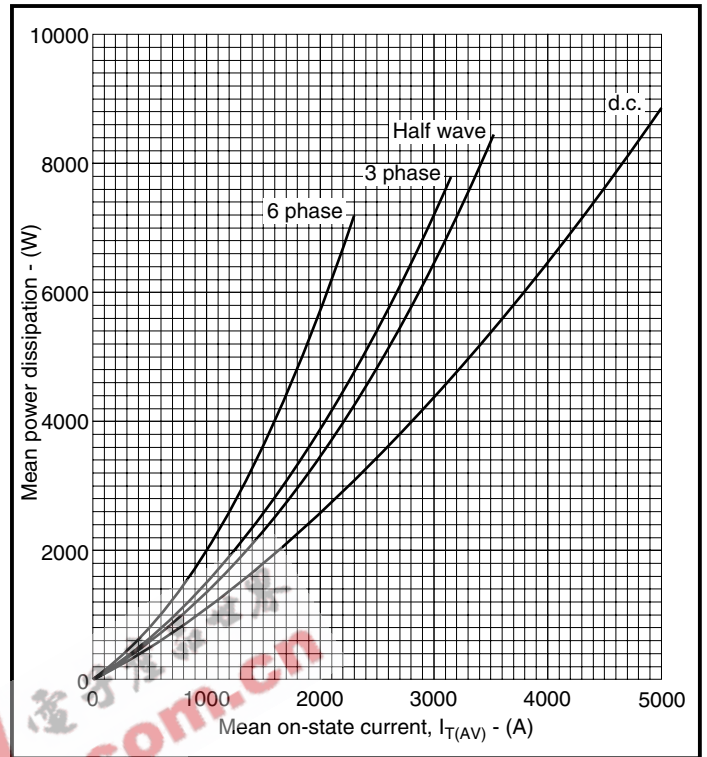

Fig.3 Dissipation curves

V_{TM} Equation:-

$$V_{TM} = A + B \ln(I_T) + C \cdot I_T + D \cdot \sqrt{I_T}$$

Where

- A = 0.8497627
- B = -0.03614853
- C = 5.286579 x 10⁻⁵
- D = 0.01334724

these values are valid for $T_j = 125^\circ\text{C}$ for I_T 500A to 5000A

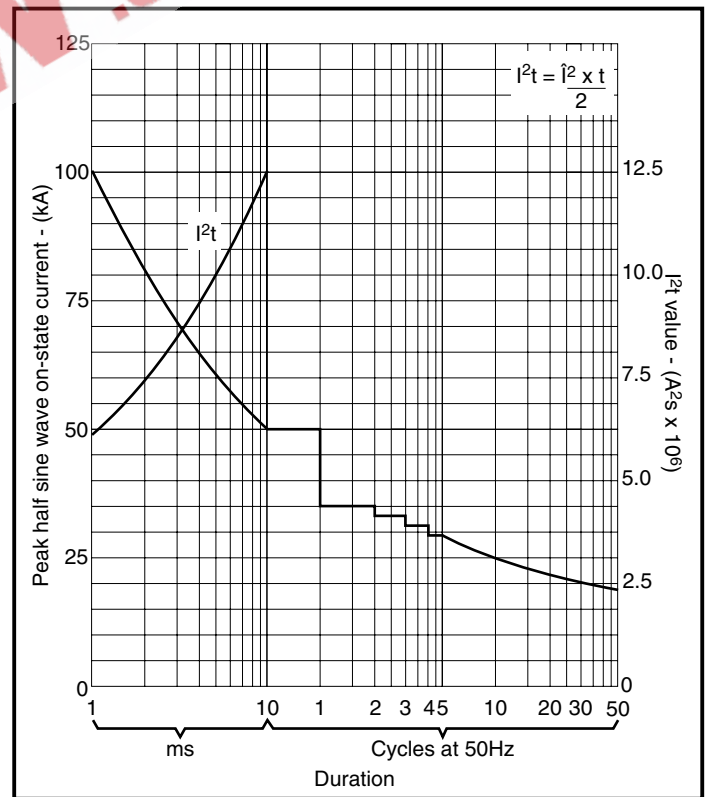
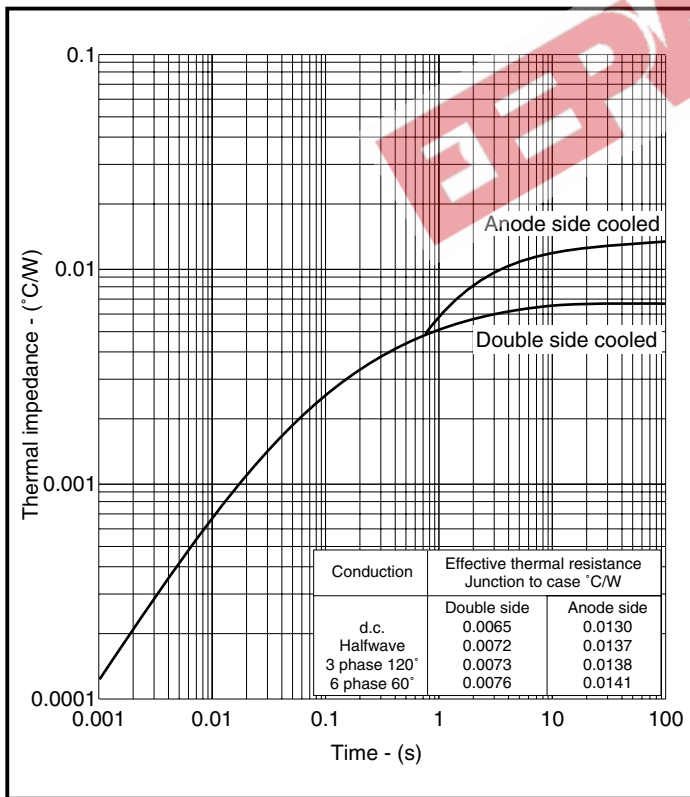
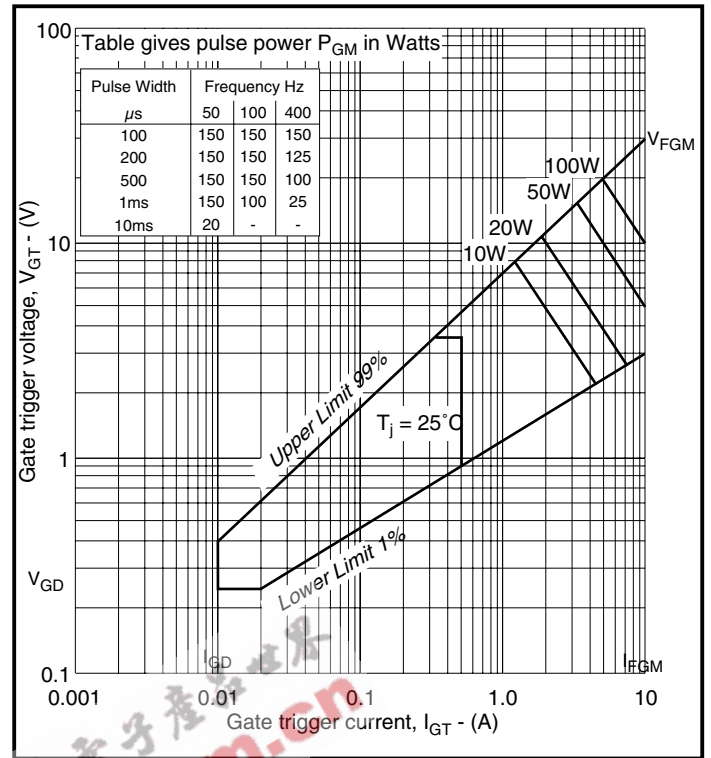
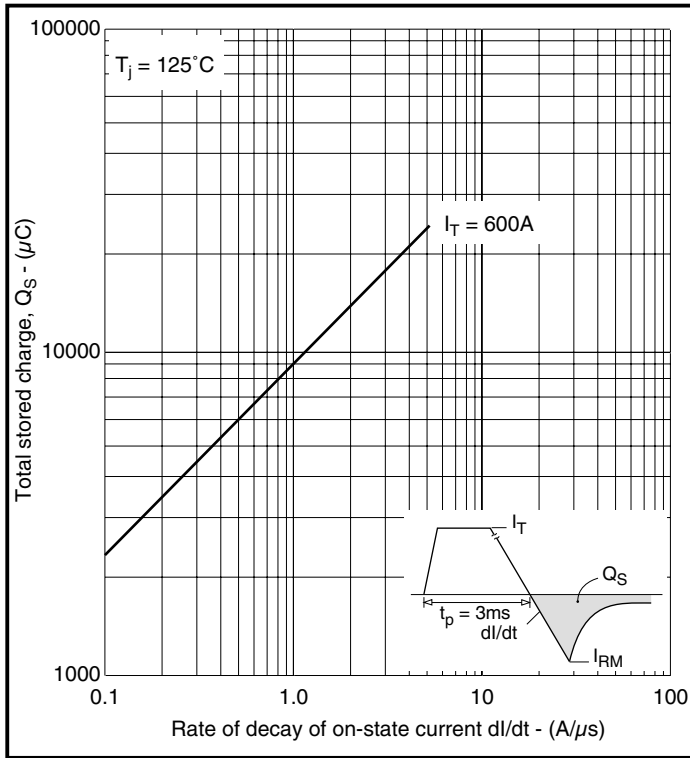

PACKAGE DETAILS

For further package information, please contact Customer Services. All dimensions in mm, unless stated otherwise. DO NOT SCALE.

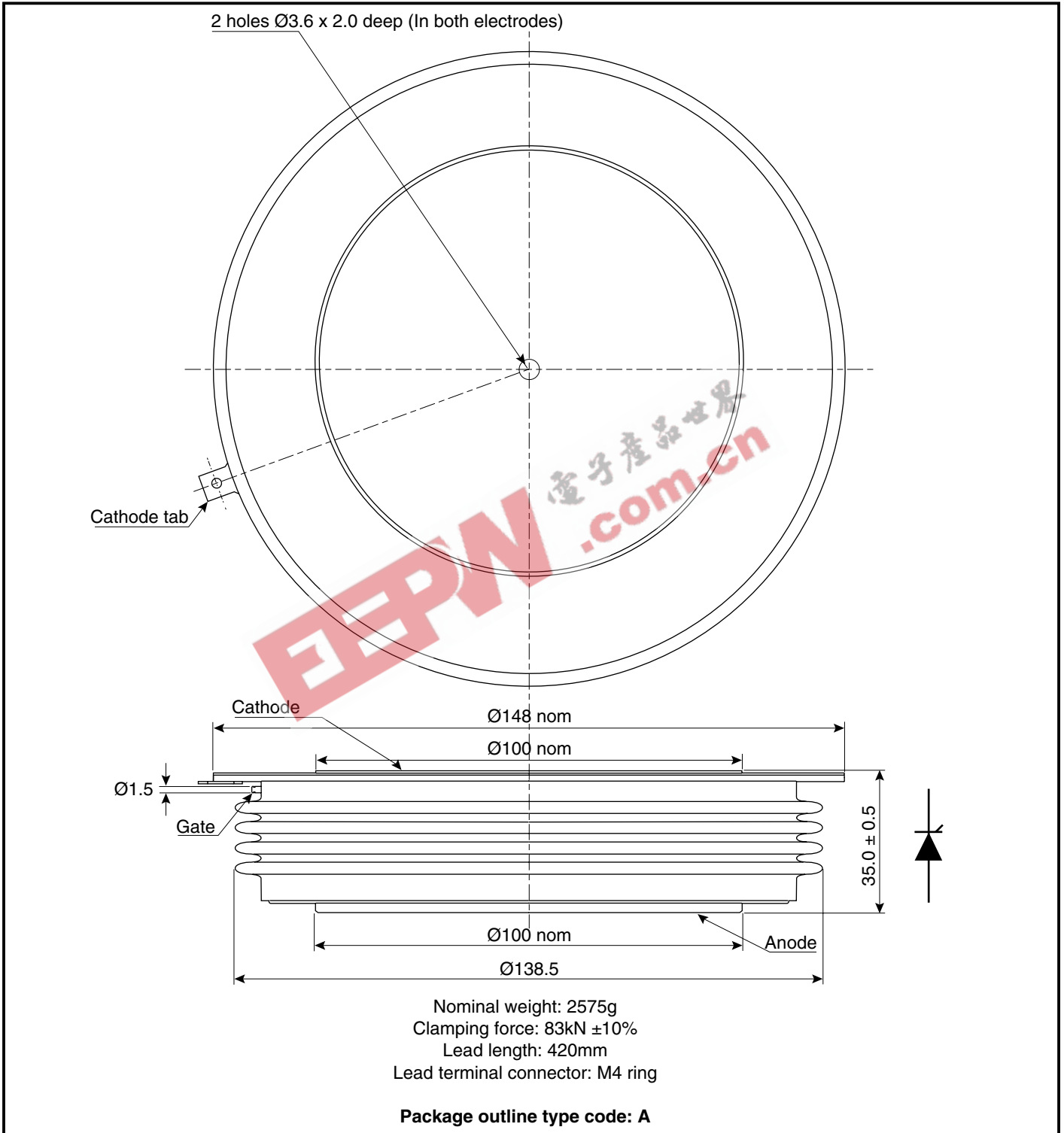

Fig.8 Package outline

POWER ASSEMBLY CAPABILITY

The Power Assembly group was set up to provide a support service for those customers requiring more than the basic semiconductor, and has developed a flexible range of heatsink and clamping systems in line with advances in device voltages and current capability of our semiconductors.

We offer an extensive range of air and liquid cooled assemblies covering the full range of circuit designs in general use today. The Assembly group offers high quality engineering support dedicated to designing new units to satisfy the growing needs of our customers.

Using the latest CAD methods our team of design and applications engineers aim to provide the Power Assembly Complete Solution (PACs).

HEATSINKS

The Power Assembly group has its own proprietary range of extruded aluminium heatsinks which have been designed to optimise the performance of Dynex semiconductors. Data with respect to air natural, forced air and liquid cooling (with flow rates) is available on request.

For further information on device clamps, heatsinks and assemblies, please contact your nearest sales representative or Customer Services.

Stresses above those listed in this data sheet may cause permanent damage to the device. In extreme conditions, as with all semiconductors, this may include potentially hazardous rupture of the package. Appropriate safety precautions should always be followed.



<http://www.dynexsemi.com>

e-mail: power_solutions@dynexsemi.com

HEADQUARTERS OPERATIONS
DYNEX SEMICONDUCTOR LTD
Doddington Road, Lincoln.
Lincolnshire. LN6 3LF. United Kingdom.
Tel: +44-(0)1522-500500
Fax: +44-(0)1522-500550

CUSTOMER SERVICE
Tel: +44 (0)1522 502753 / 502901. Fax: +44 (0)1522 500020

© Dynex Semiconductor 2003 TECHNICAL DOCUMENTATION – NOT FOR RESALE. PRODUCED IN UNITED KINGDOM

This publication is issued to provide information only which (unless agreed by the Company in writing) may not be used, applied or reproduced for any purpose nor form part of any order or contract nor to be regarded as a representation relating to the products or services concerned. No warranty or guarantee express or implied is made regarding the capability, performance or suitability of any product or service. The Company reserves the right to alter without prior notice the specification, design or price of any product or service. Information concerning possible methods of use is provided as a guide only and does not constitute any guarantee that such methods of use will be satisfactory in a specific piece of equipment. It is the user's responsibility to fully determine the performance and suitability of any equipment using such information and to ensure that any publication or data used is up to date and has not been superseded. These products are not suitable for use in any medical products whose failure to perform may result in significant injury or death to the user. All products and materials are sold and services provided subject to the Company's conditions of sale, which are available on request.

All brand names and product names used in this publication are trademarks, registered trademarks or trade names of their respective owners.