

Directional Detector

Features

- Frequency Coverage: 650 MHz to 2.5 GHz
- Small Outline SC-88 (6 Lead SC-70) Package
- Built-in Temperature Compensating Diode
- Low Cost for High Volume Handset Applications
- Tape and Reel Availability

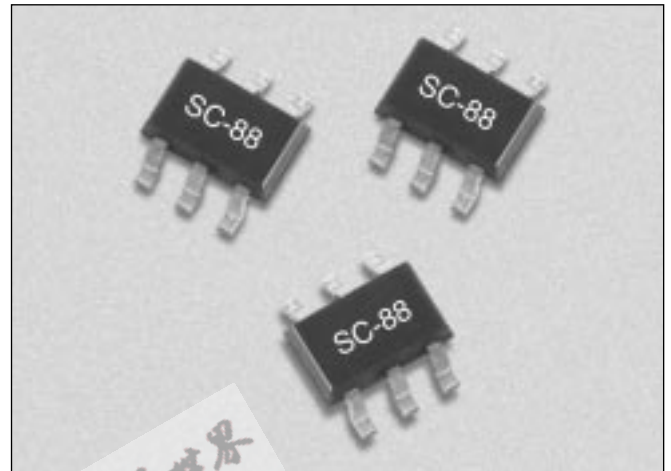

Description

The DD01-92 directional detector is an integrated directional coupler, Schottky diode combination designed for handset power monitor applications specified from 800 MHz to 2 GHz. It is packaged in the small footprint, SC-88 (6 lead SC-70) package. The DD01-92 incorporates a directional coupler and two GaAs Schottky diodes on a monolithic GaAs chip. By applying forward DC bias to both Schottky diodes, the DD01-92 may be conveniently temperature compensated. The DD01-92 is characterized from 650 MHz to 2.5 GHz and generates a detected signal at 1.8 GHz of approximately 200 mV at 10 mW input power. Each Schottky diode is forward biased to approximately 5 μ A by applying 1 V through 100 k Ω resistors as shown in the test circuit.

Pin Out

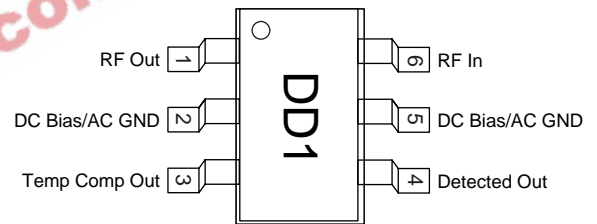

Electrical Specifications at 25°C

Parameter	Frequency	Min.	Typ.	Max.	Unit
Detected Voltage	0.8–1.2 GHz	80	120		mV
	1.8–2.0 GHz	150	200		mV
Insertion Loss	870–920 MHz		0.25	0.30	dB
	1.7–1.8 GHz		0.50	0.55	dB
Input Return Loss	0.8–1.2 GHz			20	dB
	1.2–2.0 GHz			15	dB
Output Return Loss	0.8–1.2 GHz			20	dB
	1.2–2.0 GHz			15	dB
Directivity	0.8–2.0 GHz		10		dB
Schottky Noise Voltage (1 MHz Bandwidth)	RF Power Off			200	μ V
Schottky Diode DC Voltage	RF Power Off		480		mV
DC Offset Voltage	RF Power Off		10		mV
Video Resistance	RF Power Off		7,500		Ω

Conditions: 10 dBm input power, 1 V applied to test circuit.
 Detected voltage is differential voltage, $V_4 - V_3$, on test circuit.
 Insertion loss at 870–920 MHz shall be less than 0.4 dB at 85°C.
 Insertion loss at 1.7–1.8 GHz shall be less than 0.6 dB at 85°C.

Typical Performance Data

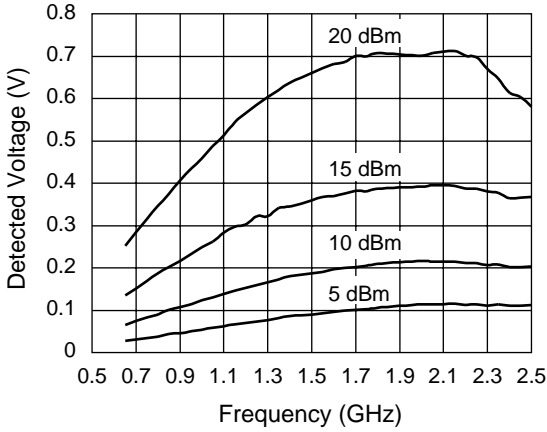

Differential Detected Voltage vs. Frequency

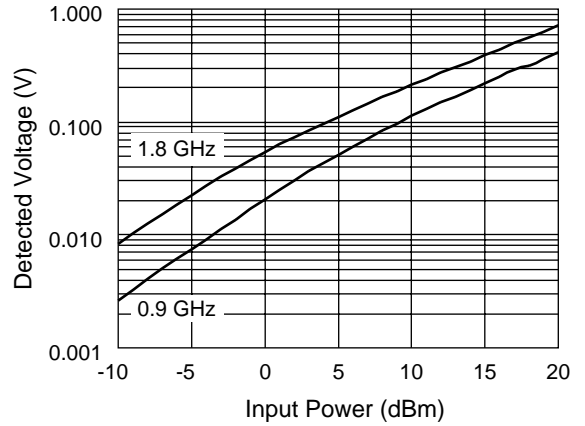

Differential Detected Voltage vs. Input Power

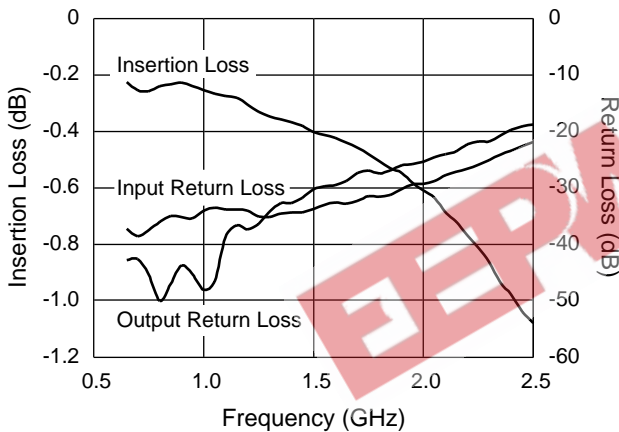

Insertion Loss and Return Loss

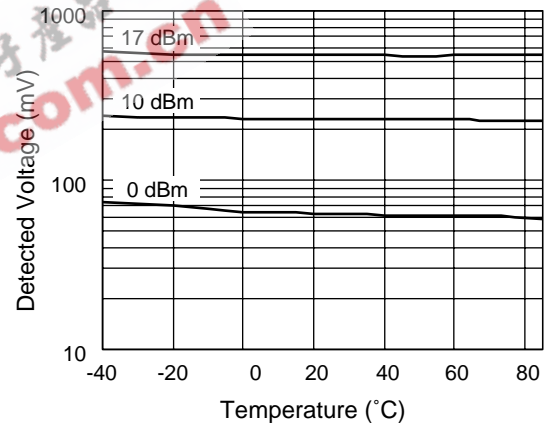

Temperature Sensitivity at 1.7 GHz

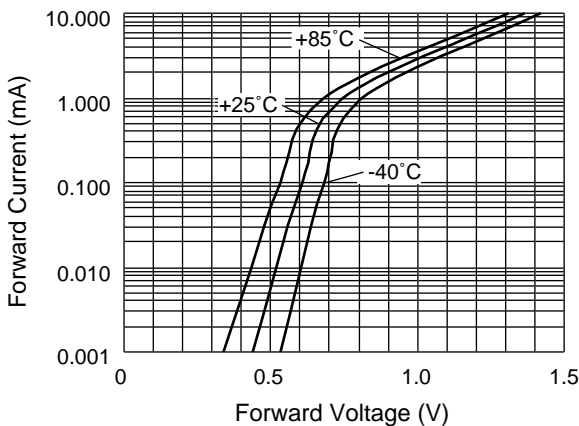

Schottky Diode DC Characteristic

Typical Detected Voltage vs. Temperature

Input Power (dBm)	V _{Out} @ -40°C (mV)	V _{Out} @ +25°C (mV)	V _{Out} @ +85°C (mV)
0	74	64	59
10	241	230	226
17	570	550	550

Conditions: 1.7 GHz, 10 dBm input power, 1 V applied to test circuit. Detected voltage is differential voltage, V₄-V₃, on test circuit.

SC-88 (6 Lead SC-70)

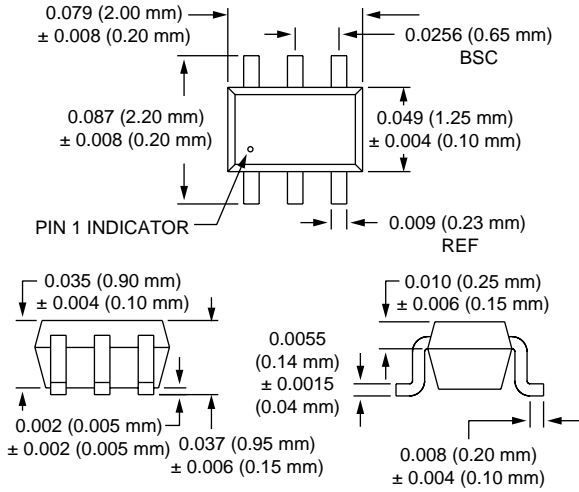

Absolute Maximum Ratings

Characteristic	Value
Incident Power (CW) @ SWR = 2.0 Max.	4 W @ < 1 GHz
	2 W @ 1–2.5 GHz
DC Bias Current	10 mA
Operating Temperature	-40 to +85°C
Storage Temperature	-65 to +150°C

Test Circuit

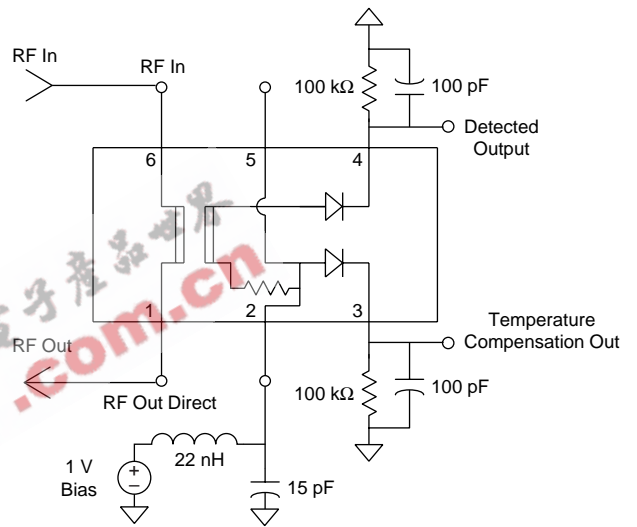

Evaluation Board Layout

