

DB35-005 ... DB35-16

Three-Phase Si-Bridge-Rectifiers Dreiphasen-Si-Brückengleichrichter

Version 2006-11-30

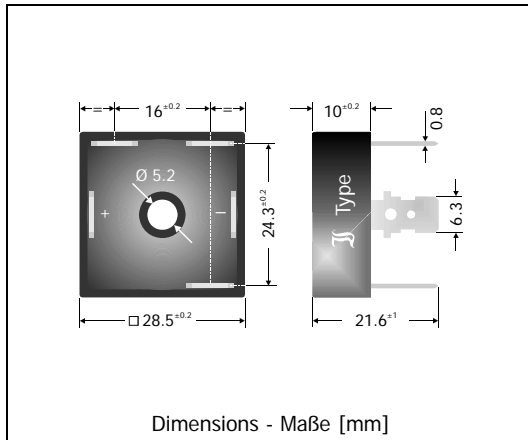

Nominal current Nennstrom	35 A
Repetitive peak reverse voltage Periodische Spitzensperrspannung	50...1600 V
Plastic case with alu bottom Plastikgehäuse mit Alu-Boden	28.5 x 28.5 x 10 [mm]
Weight approx. – Gewicht ca.	21 g
Compound has classification UL94V-0 Vergussmasse nach UL94V-0 klassifiziert	
Standard packaging bulk Standard Lieferform lose im Karton	



Recognized Product – Underwriters Laboratories Inc.® File E175067
Anerkanntes Produkt – Underwriters Laboratories Inc.® Nr. E175067

Maximum ratings**Grenzwerte**

Type Typ	Max. alternating input voltage Max. Eingangswchelsspannung V_{VRMS} [V]	Repetitive peak reverse voltage Periodische Spitzensperrspannung V_{RRM} [V] ¹⁾
DB35-005	35	50
DB35-01	70	100
DB35-02	140	200
DB35-04	280	400
DB35-06	420	600
DB35-08	560	800
DB35-10	700	1000
DB35-12	800	1200
DB35-14	900	1400
DB35-16	1000	1600

¹ Valid for one branch – Gültig für einen Brückenweig

Maximum ratings
Grenzwerte

Repetitive peak forward current Periodischer Spitzenstrom	$f > 15 \text{ Hz}$	I_{FRM}	120 A ¹⁾
Peak forward surge current 50 Hz half sine-wave Stoßstrom für eine 50 Hz Sinus-Halbwellen	$T_A = 25^\circ\text{C}$	I_{FSM}	450 A
Peak forward surge current 60 Hz half sine-wave Stoßstrom für eine 60 Hz Sinus-Halbwellen	$T_A = 25^\circ\text{C}$	I_{FSM}	500 A
Rating for fusing, $t < 10 \text{ ms}$ Grenzlastintegral, $t < 10 \text{ ms}$	$T_A = 25^\circ\text{C}$	i^2t	1000 A ² s
Operating junction temperature – Sperrschichttemperatur Storage temperature – Lagerungstemperatur		T_j T_s	-50...+150°C -50...+150°C

Characteristics
Kennwerte

Max. current with cooling fin 300 cm ² Dauergrenzstrom mit Kühlblech 300 cm ²	$T_A = 50^\circ\text{C}$	R-load C-load	I_{FAV} I_{FAV}	35 A 35 A
Forward voltage – Durchlass-Spannung	$T_j = 25^\circ\text{C}$	$I_F = 17.5 \text{ A}$	V_F	< 1.05 V ²⁾
Leakage current – Sperrstrom	$T_j = 25^\circ\text{C}$	$V_R = V_{RRM}$	I_R	< 10 µA
Isolation voltage terminals to case Isolationsspannung Anschlüsse zum Gehäuse			V_{ISO}	> 2500 V
Thermal resistance junction to case Wärmewiderstand Sperrschicht – Gehäuse			R_{thc}	< 1.8 K/W
Admissible torque for mounting Zulässiges Anzugsdrehmoment		10-32 UNF M5		18 ± 10% lb.in. 2 ± 10% Nm

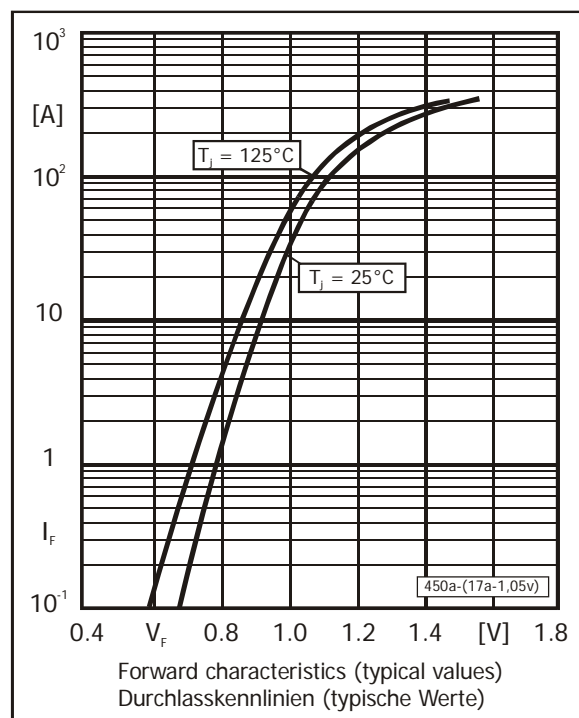
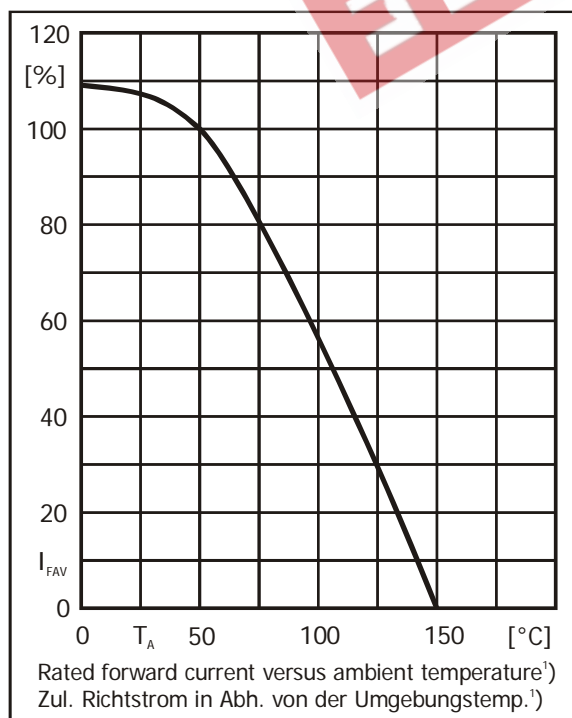

1 Valid, if the temperature of the case is kept to $T_c = 120^\circ\text{C}$ – Gültig, wenn die Gehäusetemperatur auf $T_c = 120^\circ\text{C}$ gehalten wird

2 Valid for one branch – Gültig für einen Brückenweig