

## Features

- Epitaxial Planar Die Construction
- Complementary PNP Types Available (DDTA)
- Built-In Biasing Resistor, R1 only

## Mechanical Data

- Case: SOT-23, Molded Plastic
- Case material - UL Flammability Rating 94V-0
- Moisture sensitivity: Level 1 per J-STD-020A
- Terminals: Solderable per MIL-STD-202, Method 208
- Terminal Connections: See Diagram
- Marking: Date Code and Marking Code (See Diagrams & Page 2)
- Weight: 0.008 grams (approx.)
- Ordering Information (See Page 2)

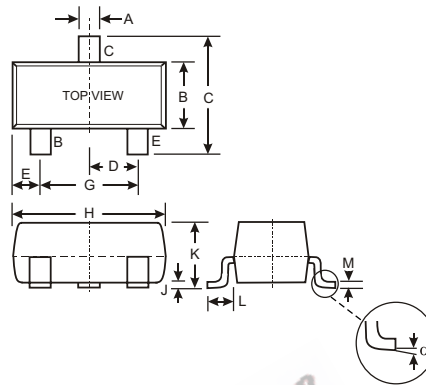

SOT-23		
Dim	Min	Max
A	0.37	0.51
B	1.20	1.40
C	2.30	2.50
D	0.89	1.03
E	0.45	0.60
G	1.78	2.05
H	2.80	3.00
J	0.013	0.10
K	0.903	1.10
L	0.45	0.61
M	0.85	0.80
α	0°	8°
All Dimensions in mm		



SCHEMATIC DIAGRAM

P/N	R1 (NOM)	MARKING
DDTC113TCA	1KΩ	N01
DDTC123TCA	2.2KΩ	N03
DDTC143TCA	4.7KΩ	N07
DDTC114TCA	10KΩ	N12
DDTC124TCA	22KΩ	N16
DDTC144TCA	47KΩ	N19
DDTC115TCA	100KΩ	N23
DDTC125TCA	200KΩ	N25

## Maximum Ratings @ T<sub>A</sub> = 25°C unless otherwise specified

Characteristic	Symbol	Value	Unit
Collector-Base Voltage	V <sub>CBO</sub>	50	V
Collector-Emitter Voltage	V <sub>CEO</sub>	50	V
Emitter-Base Voltage	V <sub>EBO</sub>	5	V
Collector Current	I <sub>C</sub> (Max)	100	mA
Power Dissipation	P <sub>d</sub>	200	mW
Thermal Resistance, Junction to Ambient Air (Note 1)	R <sub>θJA</sub>	625	°C/W
Operating and Storage and Temperature Range	T <sub>J</sub> , T <sub>STG</sub>	-55 to +150	°C

Note: 1. Mounted on FR4 PC Board with recommended pad layout at <http://www.diodes.com/datasheets/ap02001.pdf>.

**Electrical Characteristics** @  $T_A = 25^\circ\text{C}$  unless otherwise specified

Characteristic	Symbol	Min	Typ	Max	Unit	Test Condition
Collector-Base Breakdown Voltage	$BV_{CBO}$	50	—	—	V	$I_C = 50\mu\text{A}$
Collector-Emitter Breakdown Voltage	$BV_{CEO}$	50	—	—	V	$I_C = 1\text{mA}$
Emitter-Base Breakdown Voltage	$BV_{EBO}$	5	—	—	V	$I_E = 50\mu\text{A}$
Collector Cutoff Current	$I_{CBO}$	—	—	0.5	$\mu\text{A}$	$V_{CB} = 50\text{V}$
Emitter Cutoff Current	$I_{EBO}$	—	—	0.5	$\mu\text{A}$	$V_{EB} = 4\text{V}$
Collector-Emitter Saturation Voltage	$V_{CE(sat)}$	—	—	0.3	V	$I_C/I_B = 10\text{mA}/1\text{mA}$ DDTC113TCA $I_C/I_B = 5\text{mA}/0.5\text{mA}$ DDTC123TCA $I_C/I_B = 2.5\text{mA}/.25\text{mA}$ DDTC143TCA $I_C/I_B = 1\text{mA}/.1\text{mA}$ DDTC114TCA $I_C/I_B = 5\text{mA}/0.5\text{mA}$ DDTC124TCA $I_C/I_B = 2.5\text{mA}/.25\text{mA}$ DDTC144TCA $I_C/I_B = 1\text{mA}/0.1\text{mA}$ DDTC115TCA $I_C/I_B = .5\text{mA}/.05\text{mA}$ DDTC125TCA
DC Current Transfer Ratio	$h_{FE}$	100	250	600	—	$I_C = 1\text{mA}, V_{CE} = 5\text{V}$
Input Resistor ( $R_1$ ) Tolerance	$DR_1$	-30	—	+30	%	—
Gain-Bandwidth Product*	$f_T$	—	250	—	MHz	$V_{CE} = 10\text{V}, I_E = -5\text{mA}, f = 100\text{MHz}$

\* Transistor - For Reference Only

**Ordering Information**

Device	Packaging	Shipping
DDTC113TCA-7	SOT-23	3000/Tape & Reel
DDTC123TCA-7	SOT-23	3000/Tape & Reel
DDTC143TCA-7	SOT-23	3000/Tape & Reel
DDTC114TCA-7	SOT-23	3000/Tape & Reel
DDTC124TCA-7	SOT-23	3000/Tape & Reel
DDTC144TCA-7	SOT-23	3000/Tape & Reel
DDTC115TCA-7	SOT-23	3000/Tape & Reel
DDTC125TCA-7	SOT-23	3000/Tape & Reel

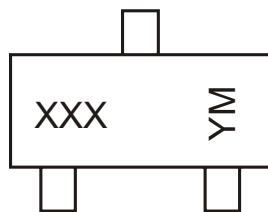
Notes: 2. For Packaging Details, go to our website at <http://www.diodes.com/datasheets/ap02007.pdf>.**Marking Information**

XXX = Product Type Marking Code  
 See Sheet 1 Diagrams  
 YM = Date Code Marking  
 Y = Year ex: N = 2002  
 M = Month ex: 9 = September

## Date Code Key

Year	2002	2003	2004	2005	2006	2007	2008	2009
Code	N	P	R	S	T	U	V	W

Month	Jan	Feb	March	Apr	May	Jun	Jul	Aug	Sep	Oct	Nov	Dec
Code	1	2	3	4	5	6	7	8	9	O	N	D

TYPICAL CURVES - DDTC114TCA

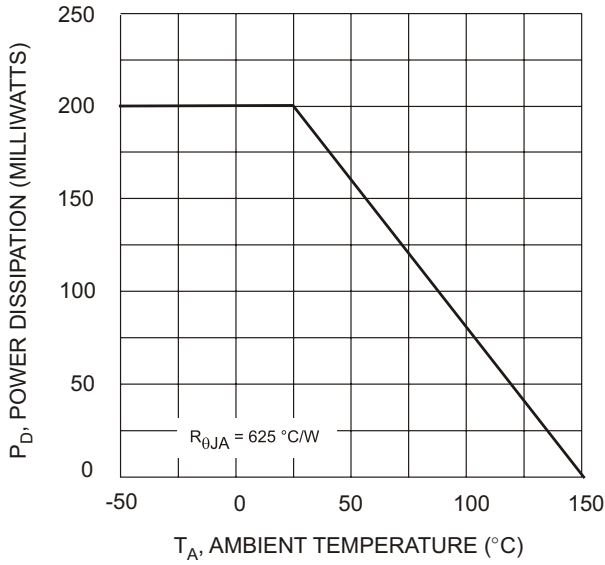

Fig. 1 Derating Curve

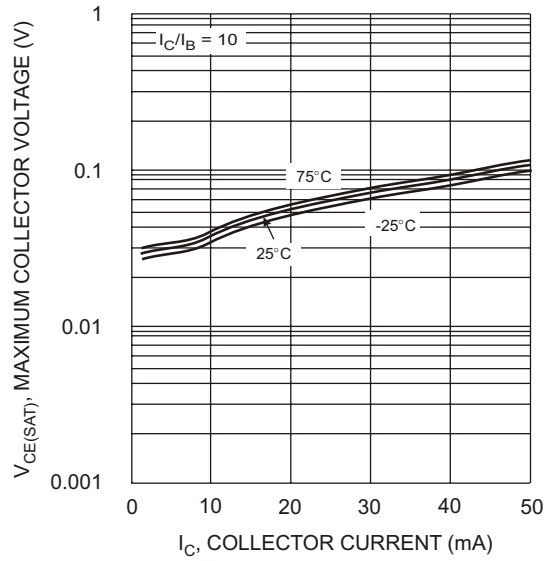

Fig. 2  $V_{CE(SAT)}$  vs.  $I_C$

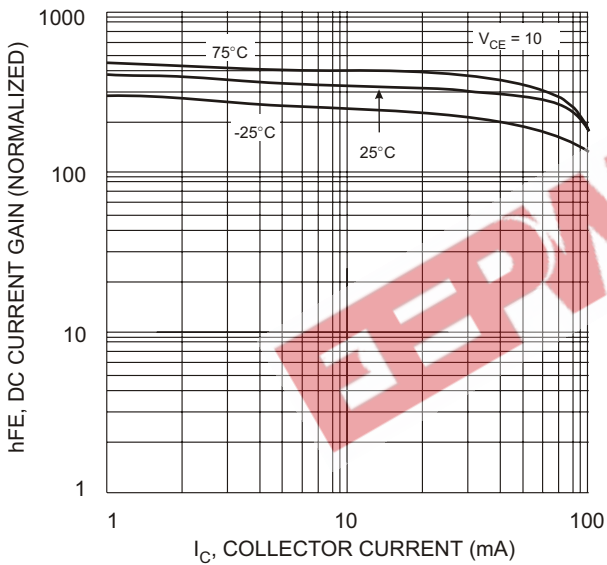

Fig. 3 DC Current Gain

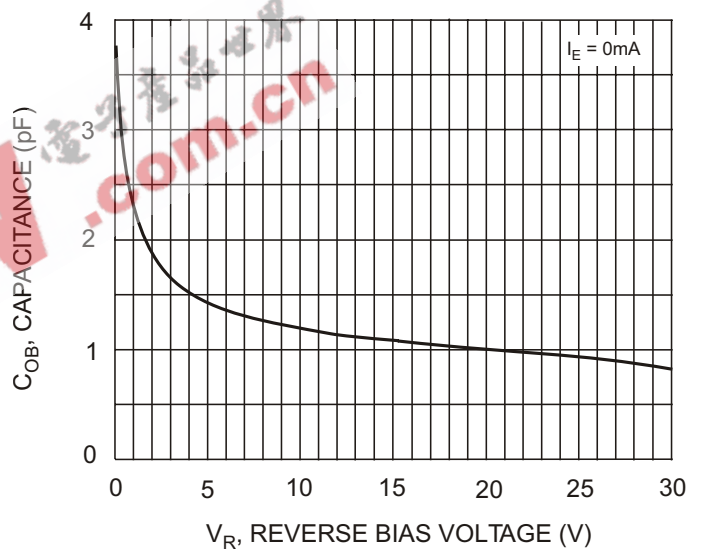

Fig. 4 Output Capacitance

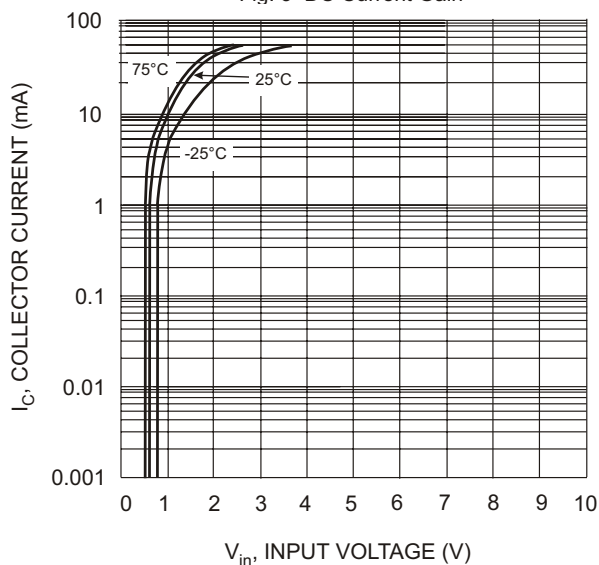

Fig. 5 Collector Current Vs. Input Voltage

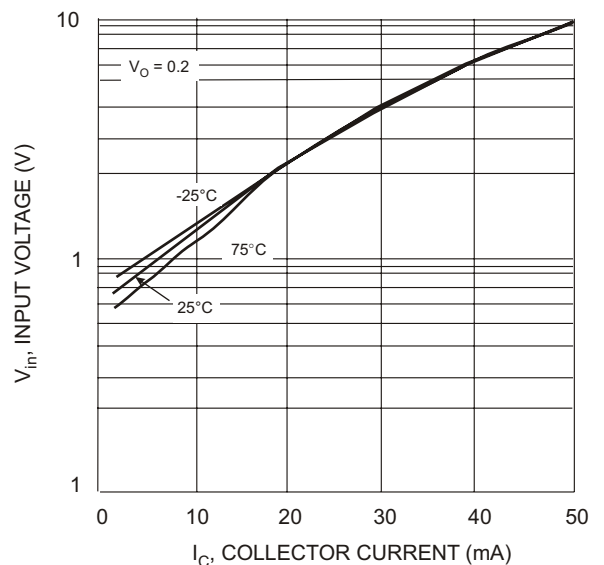

Fig. 6 Input Voltage vs. Collector Current