

Features

- Epitaxial Planar Die Construction
- Complementary NPN Types Available (DDTC)
- Built-In Biasing Resistors, R1≠R2
- Lead Free/RoHS Compliant (Note 2)

Mechanical Data

- Case: SOT-23
- Case Material: Molded Plastic. UL Flammability Classification Rating 94V-0
- Moisture Sensitivity: Level 1 per J-STD-020C
- Terminal Connections: See Diagram
- Terminals: Solderable per MIL-STD-202, Method 208
- Lead Free Plating (Matte Tin Finish annealed over Alloy 42 leadframe).
- Marking: Date Code and Marking Code (See Table Below & Page 3)
- Ordering Information (See Page 2)
- Weight: 0.008 grams (approximate)

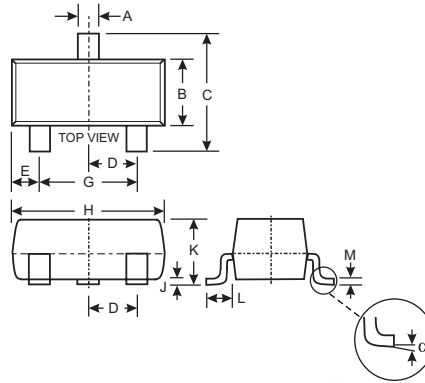

SOT-23		
Dim	Min	Max
A	0.37	0.51
B	1.20	1.40
C	2.30	2.50
D	0.89	1.03
E	0.45	0.60
G	1.78	2.05
H	2.80	3.00
J	0.013	0.10
K	0.903	1.10
L	0.45	0.61
M	0.085	0.180
α	0°	8°
All Dimensions in mm		

P/N	R1 (NOM)	R2 (NOM)	MARKING
DDTA113ZCA	1KΩ	10KΩ	P02
DDTA123YCA	2.2KΩ	10KΩ	P05
DDTA123JCA	2.2KΩ	47KΩ	P06
DDTA143XCA	4.7KΩ	10KΩ	P09
DDTA143FCA	4.7KΩ	22KΩ	P10
DDTA143ZCA	4.7KΩ	47KΩ	P11
DDTA114YCA	10KΩ	47KΩ	P14
DDTA114WCA	10KΩ	4.7KΩ	P15
DDTA124XCA	22KΩ	47KΩ	P18
DDTA144VCA	47KΩ	10KΩ	P21
DDTA144WCA	47KΩ	22KΩ	P22

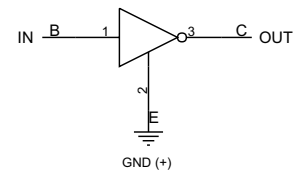
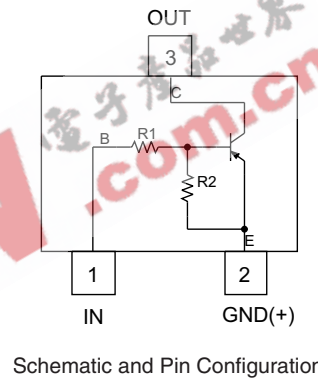

Maximum Ratings @ T_A = 25°C unless otherwise specified

Characteristic	Symbol	Value	Unit
Supply Voltage, (3) to (2)	V _{CC}	-50	V
Input Voltage, (1) to (2)	V _{IN}	DDTA113ZCA: +5 to -10 DDTA123YCA: +5 to -12 DDTA123JCA: +5 to -12 DDTA143XCA: +7 to -20 DDTA143FCA: +6 to -30 DDTA143ZCA: +5 to -30 DDTA114YCA: +6 to -40 DDTA114WCA: +10 to -30 DDTA124XCA: +10 to -40 DDTA144VCA: +15 to -40 DDTA144WCA: +10 to -40	V
Output Current	I _O	DDTA113ZCA: -100 DDTA123YCA: -100 DDTA123JCA: -100 DDTA143XCA: -100 DDTA143FCA: -100 DDTA143ZCA: -100 DDTA114YCA: -70 DDTA114WCA: -100 DDTA124XCA: -50 DDTA144VCA: -30 DDTA144WCA: -30	mA
Output Current	I _C (Max)	-100	mA
Power Dissipation	P _d	200	mW
Thermal Resistance, Junction to Ambient Air (Note 1)	R _{θJA}	625	°C/W
Operating and Storage and Temperature Range	T _j , T _{STG}	-55 to +150	°C

Note: 1. Mounted on FR4 PC Board with recommended pad layout at <http://www.diodes.com/datasheets/ap02001.pdf>.
2. No purposefully added lead.

Electrical Characteristics @ T_A = 25°C unless otherwise specified

Characteristic		Symbol	Min	Typ	Max	Unit	Test Condition	
Input Voltage	DDTA113ZCA DDTA123YCA DDTA123JCA DDTA143XCA DDTA143FCA DDTA143ZCA DDTA114YCA DDTA114WCA DDTA124XCA DDTA144VCA DDTA144WCA	V _{I(off)}	-0.3 -0.3 -0.5 -0.3 -0.3 -0.5 -0.3 -0.8 -0.4 -1.0 -0.8	—	—	—	V	V _{CC} = 5V, I _O = 100μA
	DDTA113ZCA DDTA123YCA DDTA123JCA DDTA143XCA DDTA143FCA DDTA143ZCA DDTA114YCA DDTA114WCA DDTA124XCA DDTA144VCA DDTA144WCA	V _{I(on)}	—	—	-3.0 -3.0 -1.1 -2.5 -1.3 -1.3 -1.4 -3.0 -2.5 -5.0 -4.0	—	V	V _O = -0.3V, I _O = -20mA V _O = -0.3V, I _O = -20mA V _O = -0.3V, I _O = -5mA V _O = -0.3V, I _O = -20mA V _O = -0.3V, I _O = -3mA V _O = -0.3V, I _O = -5mA V _O = -0.3V, I _O = -1mA V _O = -0.3V, I _O = -2mA V _O = -0.3V, I _O = -2mA V _O = -0.3V, I _O = -2mA V _O = -0.3V, I _O = -2mA
Output Voltage		V _{O(on)}	—	-0.1	-0.3	V	I _O /I _I = -5mA/-0.25mA DDTA123JCA I _O /I _I = -5mA/-0.25mA DDTA143ZCA I _O /I _I = -5mA/-0.25mA DDTA114YCA I _O /I _I = -10mA/-0.5mA All Others	
Input Current	DDTA113ZCA DDTA123YCA DDTA123JCA DDTA143XCA DDTA143FCA DDTA143ZCA DDTA114YCA DDTA114WCA DDTA124XCA DDTA144VCA DDTA144WCA	I _I	—	—	-7.2 -3.8 -3.6 -1.8 -1.8 -1.8 -0.88 -0.88 -0.36 -0.16 -0.16	mA	V _I = -5V	
Output Current		I _{O(off)}	—	—	-0.5	μA	V _{CC} = -50V, V _I = 0V	
DC Current Gain	DDTA113ZCA DDTA123YCA DDTA123JCA DDTA143XCA DDTA143FCA DDTA143ZCA DDTA114YCA DDTA114WCA DDTA124XCA DDTA144VCA DDTA144WCA	G _I	-33 -33 -80 -30 -68 -80 -68 -24 -68 -33 -56	—	—	—	V _O = -5V, I _O = -10mA	
Input Resistor Tolerance		ΔR ₁	-30	—	+30	%	—	
Resistance Ratio Tolerance		ΔR ₂ /R ₁	-20	—	+20	%	—	
Gain-Bandwidth Product*		f _T	—	250	—	MHz	V _{CE} = -10V, I _E = 5mA, f = 100MHz	

* Transistor - For Reference Only

Ordering Information (Note 3)

Device	Packaging	Shipping
DDTA113ZCA-7-F	SOT-23	3000/Tape & Reel
DDTA123YCA-7-F	SOT-23	3000/Tape & Reel
DDTA123JCA-7-F	SOT-23	3000/Tape & Reel
DDTA143XCA-7-F	SOT-23	3000/Tape & Reel
DDTA143FCA-7-F	SOT-23	3000/Tape & Reel
DDTA143ZCA-7-F	SOT-23	3000/Tape & Reel
DDTA114YCA-7-F	SOT-23	3000/Tape & Reel
DDTA114WCA-7-F	SOT-23	3000/Tape & Reel
DDTA124XCA-7-F	SOT-23	3000/Tape & Reel
DDTA144VCA-7-F	SOT-23	3000/Tape & Reel
DDTA144WCA-7-F	SOT-23	3000/Tape & Reel

Notes: 3. For Packaging Details, go to our website at <http://www.diodes.com/datasheets/ap02007.pdf>.

Marking Information

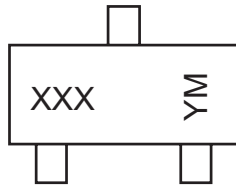

XXX = Product Type Marking Code, See Table on Page 1
 YM = Date Code Marking
 Y = Year ex: T = 2006
 M = Month ex: 9 = September

Date Code Key

Year	2002	2003	2004	2005	2006	2007	2008	2009
Code	N	P	R	S	T	U	V	W

Month	Jan	Feb	Mar	Apr	May	Jun	Jul	Aug	Sep	Oct	Nov	Dec
Code	1	2	3	4	5	6	7	8	9	O	N	D



TYPICAL CURVES - DDTA123JCA

NEW PRODUCT

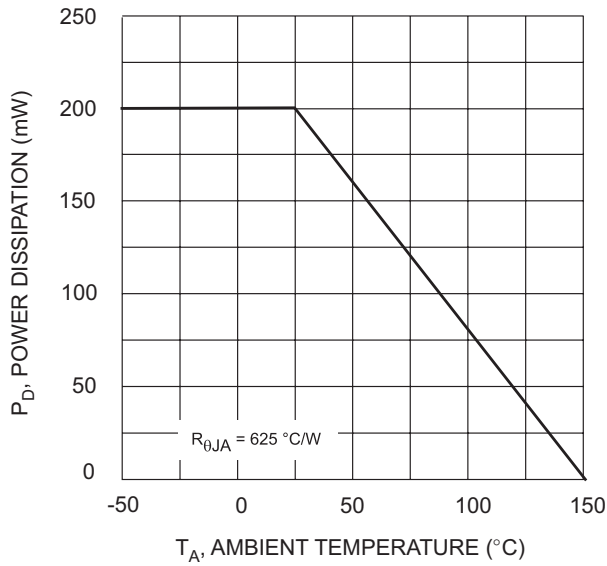

Fig. 1 Derating Curve

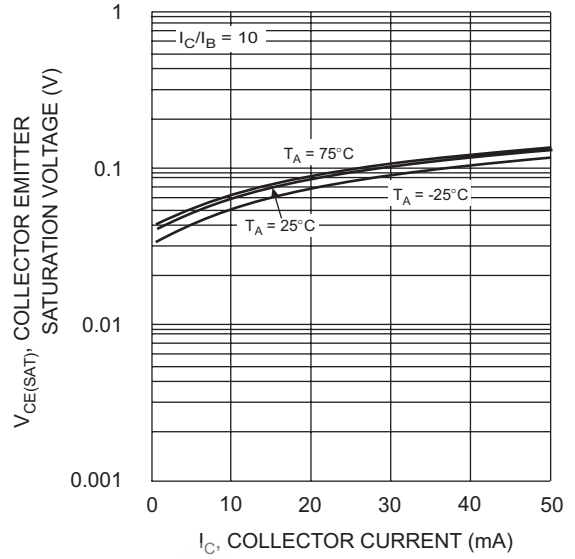

Fig. 2 $V_{CE(SAT)}$ vs. I_C

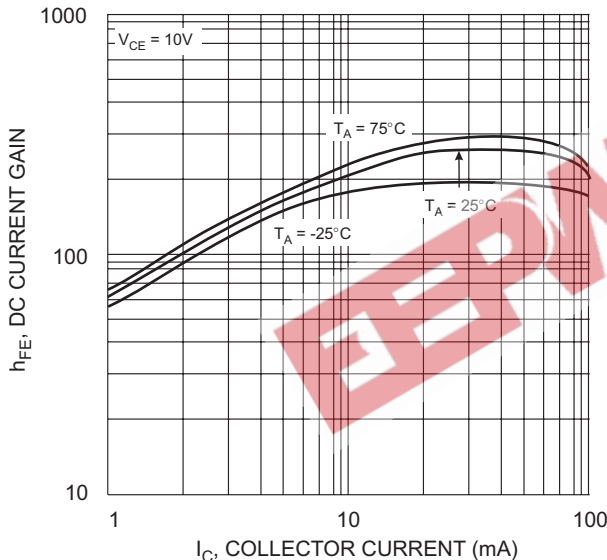

Fig. 3 DC CURRENT GAIN

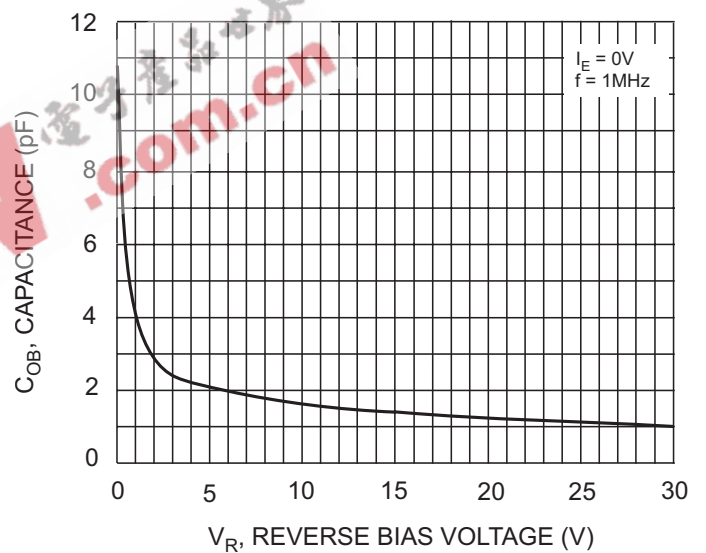

Fig. 4 Output Capacitance

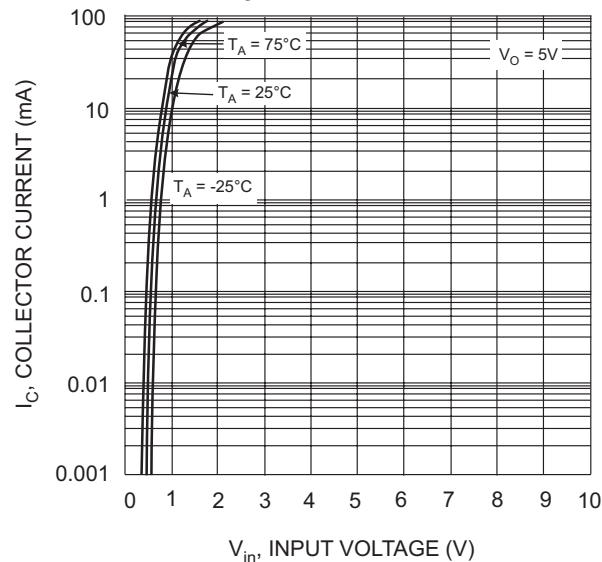

Fig. 5 Collector Current Vs. Input Voltage

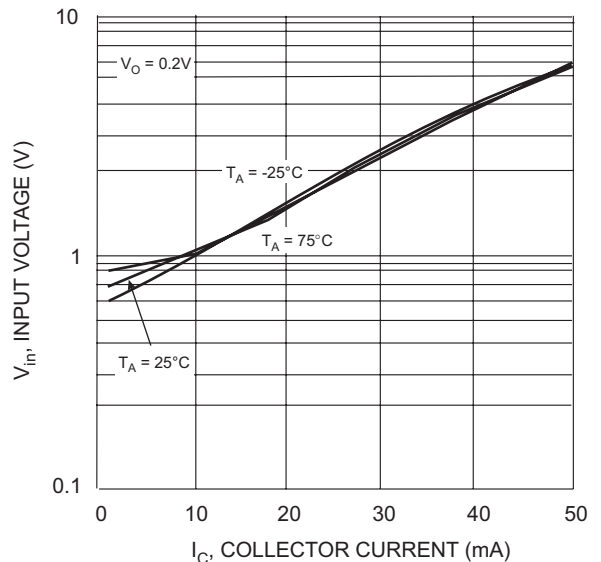

Fig. 6 Input Voltage vs. Collector Current

IMPORTANT NOTICE

Diodes Incorporated and its subsidiaries reserve the right to make modifications, enhancements, improvements, corrections or other changes without further notice to any product herein. Diodes Incorporated does not assume any liability arising out of the application or use of any product described herein; neither does it convey any license under its patent rights, nor the rights of others. The user of products in such applications shall assume all risks of such use and will agree to hold Diodes Incorporated and all the companies whose products are represented on our website, harmless against all damages.

LIFE SUPPORT

Diodes Incorporated products are not authorized for use as critical components in life support devices or systems without the expressed written approval of the President of Diodes Incorporated.

EEPW 电子產品世界
.com.cn